



ALLIED MACHINE & ENGINEERING

Holemaking Solutions for Today's Manufacturing



Drilling



Boring



Reaming



Burnishing



Threading



Special Tooling Solutions

► *SPECIALS*

Featuring
 **SUPERION**[®]

SECTION

X

Special Tooling Solutions

Special Tooling Solutions

Superion® | Insta-Quote® | Engineered Specials



Specialty is Our Specialty

When it comes to designing and developing special solutions for customers, Allied Machine is the top choice. Our engineers see applications in ways many others don't, and that ability allows us to win situations that haven't been won before.

If you have a particularly unique or difficult application, give us a call. Most of our tooling can be tweaked as specials, and we can create entirely new concepts if alterations to standard product won't do the trick.

After all, everyone deserves some special attention.



Your safety and the safety of others is very important. This catalog contains important safety messages. Always read and follow all safety precautions.



This triangle is a safety hazard symbol. It alerts you to potential safety hazards that can cause tool failure and serious injury.

When you see this symbol in the catalog, look for a related safety message that may be near this triangle or referred to in the nearby text.

There are safety signal words also used in the catalog. Safety messages follow these words.

WARNING

WARNING (shown above) means that failure to follow the precautions in this message could result in tool failure and serious injury.

NOTICE means that failure to follow the precautions in this message could result in damage to the tool or machine but not result in personal injury.

NOTE and **IMPORTANT** are also used. These are important that you read and follow but are not safety-related.

Visit www.alliedmachine.com for the most up-to-date information and procedures.

Special Tooling Solutions Contents

Introduction Information

Overview of Specials Capabilities 2 - 3

Superion® Solid Carbide and PCD Tooling 4 - 5

Insta-Quote®

Program Overview 6

User Guide 7 - 9

T-A® Inserts 10

T-A® Holders 11

GEN3SYS® XT Holders 12

ALVAN® Reamers 13

Engineered Specials

Insert Designs 14

Vaccum Drill 15

Guided T-A® 16

Success Stories 17

i-Form 18 - 19

Special Design Examples 20 - 21

QDSI™ Inserts 22 - 23

Send in Your Own Design 24 - 25

Deep Hole Drilling Guidelines 26

Special Tooling Options

Special Tooling is Our Specialty

Allied Machine offers three methods for obtaining special tooling to solve any application problem you encounter: Superior®, Insta-Quote®, and Engineered Specials. We know standard tooling can't be the answer for everyone, and that's why we specialize in developing unique tooling to fit your needs.

Many of our products can be altered as specials. In fact, many of our standard items are results of frequently requested special features. Many times, one special design can end up solving problems for multiple customers across a variety of industries. Our specials capabilities truly set us apart from our competition.

Our Application Engineering team and Field Sales Engineers are trained and highly skilled to develop unique solutions that you won't find anywhere else. If you need special tooling, give us a call. Let us be the ones to tell you it can't be done. But don't expect us to.

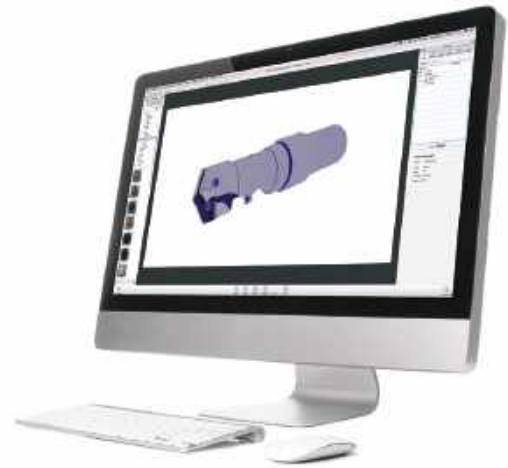

Solid Carbide Specials



Advanced Capabilities

With the addition of the Superior solid carbide products, Allied Machine can now provide made-to-order special tooling to better help customers achieve optimal performance and productivity in their holmaking applications. Give us a call today and see the new solutions we can provide.

Made-to-Order Solid Carbide Specials

- PCD Tooling.
- Burnishing Drills.
- Solid Carbide Drills.
- Step Drills / PCD Step Reamers.



Insta-Quote®

Insta-Quote is an online custom tool designer. The program is available 24/7 and guides you through the steps as you create a special tool designed to meet the requirements of your application.

Products Available:

- T-A® Inserts.
- T-A® Holders.
- GEN3SYS® XT Holders.
- ALVAN® Reamers.



See pages X: 6 - 13



Engineered Specials

When the requirements of your application fall outside the limitations of Insta-Quote, your special tooling becomes an Engineered Special. These are tool designs that our engineers get to create and develop specifically for you.

Reasons to Call:

- Many standard products can be specially engineered.
- Allied Machine specials can save you time and increase tool life.
- Our engineers have the skills and knowledge to create designs that meet the challenge.



See pages X: 14 - 21

Industry Solutions

Every Industry Needs Some Special Attention

Many specific industry applications can be tricky, and processes can change drastically from one sector to the next. Allied's Field Sales Engineers and Application Engineers work together to develop breakthrough solutions that help customers master processes that before seemed impossible to improve.

You know your parts. You know your materials. You know what works and what doesn't. All you need to do is let us know what you're dealing with, and we'll take it from there. Whether you're machining the wings of an airplane or the engine block in a new car, we'll develop the right design to solve the problem you're facing.

For more industry examples, see Allied Machine's case studies at www.alliedmachine.com/RealLifeResults.



Automotive
Engine Block



Aerospace
Central Fuselage Wing Box



Heavy Machinery
Track Links



Oil and Gas
Heat Exchanger

COMPLEX SOLUTIONS



INNOVATIVE SOLUTIONS



LONG SOLUTIONS



EVERY PROBLEM
HAS A
SOLUTION

WHAT IS SUPERION?

Superion capabilities provide cutting-edge solutions in both solid carbide and PCD tooling.

WHY SHOULD YOU USE SUPERION?

- State-of-the-art manufacturing automation allows for high repeatability and consistency, regardless of the quantity you need.
- Superion provides application-specific solutions tailored to meet your toughest demands.
- Superion tooling excels in difficult and unique material applications.
- Our goal is to provide you a quality solution to exceed your need on a schedule that satisfies.

WHEN SHOULD YOU USE SUPERION?

- When finish is critical and dimensions are tight, Superion will deliver a tool to maintain your tolerances.
- When your tooling budget requires regrinds and the ability to remanufacture, Superion tackles your needs.
- If you're dealing with CFRP or other unique materials, Superion tooling is the right solution.



A
DRILLING
B
BORING
C
REAMING
D
BURNISHING
E
THREADING
X
SPECIALS

AEROSPACE / Landing Gear Components



DRILL BURNISH TOOLS

Reduce cycle time, increase throughput, and increase profitability by combining roughing and finishing operations using our burnishing geometry for applications in which surface finish and hole tolerance are critical.

AUTOMOTIVE / Crankshafts

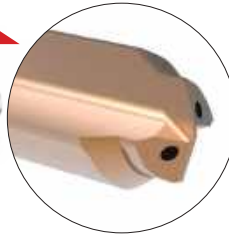

COMBINATION TOOLS

Combine multiple steps and various profile features to improve throughput. Combination tools reduce cost per hole and increase profit potential.

HEAVY EQUIPMENT / Manifolds



SOLID CARBIDE TOOLS WITH COOLANT

Solid carbide solutions optimize the manufacturing of manifolds. Most port specs call for at least three steps, and combining these features can reduce costs and increase throughput.

AUTOMOTIVE / Transmission Components



SOLID CARBIDE STEP TOOLS

You can rely on Superion's state-of-the-art manufacturing facility, built specifically to satisfy the customer's needs. Whether it's 10 drills or 1,000 drills, Superion will provide consistent and effective solutions to your production needs.

Superion®

Solid Carbide and PCD Tooling Solutions

From Concept to Reality

Allied's team of engineers is ready to assist you with your application. We'll gather all the information we need about your application and turn your concept into reality. Give us a call today, and we will collaborate with you and listen to your needs, formulate a concept, develop the model, and build the solution.

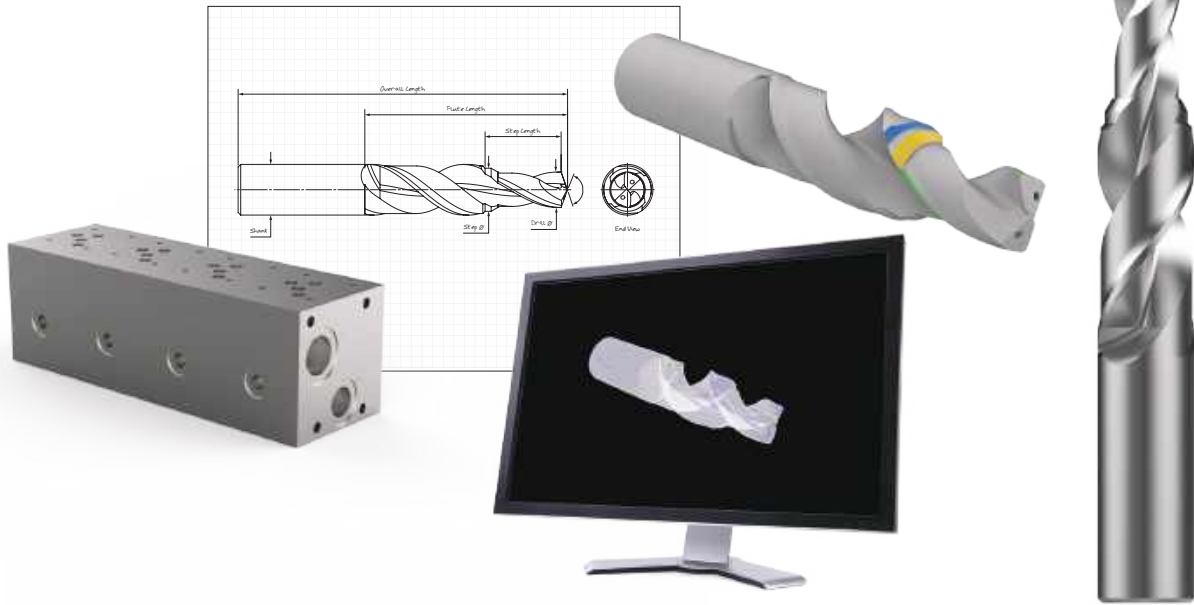

The Challenge of CFRP Materials

Carbon fiber material is ideal for industries that require components with high strength and rigidity without increasing weight. In other words, these products need to be really strong and sturdy but also really light. For example, the aerospace industry revolves around aerodynamics, which is why carbon fiber is utilized to increase the quality of aerospace components without increasing the weight.

Many other metals are composed of uniform properties that are the same in every direction. Carbon fiber, on the other hand, is made of fabrics that are specifically positioned in different directions. This configuration increases the strength and rigidity of the material, but it also makes carbon fiber much more difficult to drill.

Results When Drilling Aerospace-Grade Carbon Fiber



Holes drilled with CVD drill insert



Holes drilled with PCD tooling

Just Look at That!

These images tell the whole story. Check out the holes drilled by the PCD tooling versus the CVD insert. Notice the excessive delamination on the first group of holes. The PCD tooling avoids most delamination, resulting in an excellent hole in the difficult-to-drill carbon fiber material.

Carbon fiber has high strength that causes:

- Wear on the cutting tool.
- Splintering/fraying of the hole.

As you can see, the first test experienced these problems. The PCD tooling, however, successfully drilled clean holes.

Insta-Quote®

Design Your Custom Tooling

Insta-Quote®

Design your custom tooling and receive a drawing and quote...all within *minutes*.

iq.alliedmachine.com



Design Your Own Solutions

Insta-Quote is an online program that allows you to design and quote your own tooling in a matter of minutes. After you log in, Insta-Quote will guide you through the steps to gather all the necessary information and generate the solution you need. Within the system, you can choose from the following tools to design:

- T-A® Inserts.
- T-A® Holders.
- GEN3SYS® XT Holders.

Along with designing these products as specials, Insta-Quote can also help you create your item number for ALVAN® Reamers. Because reamer item numbers do not follow the same method as Allied Machine's standard products, you must build your reamer item numbers. Insta-Quote can do that for you.

- Replaceable Head Style.
- Monobloc Style.
- Cutting Ring Style.



Design anytime from anywhere.
Available online 24/7.



Insta-Quote®

User Guide



Where Do I Find Insta-Quote?

There are two ways to get to the Insta-Quote program. You can visit the Allied Machine homepage (www.alliedmachine.com) and find it under the Online Tools section of the upper navigation.

Or you can simply go to iq.alliedmachine.com to access Insta-Quote directly.

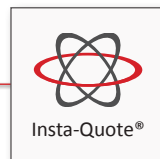

OR iq.alliedmachine.com

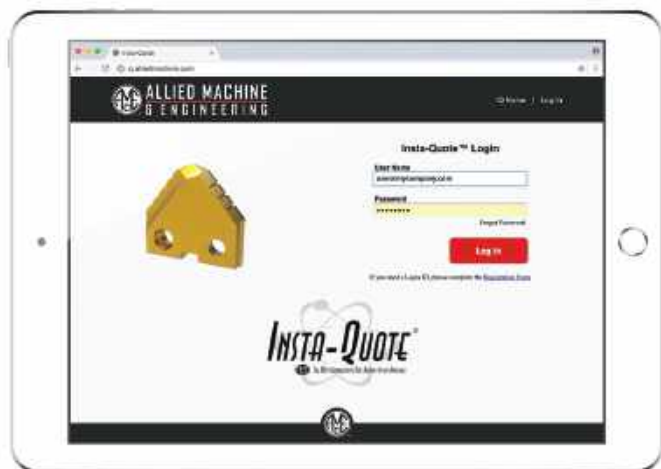

1

Log In

Fill in "User Name" and "Password" and click the login button. If you do not have a login, just click the "Registration Form" option beneath the login button and submit your registration.

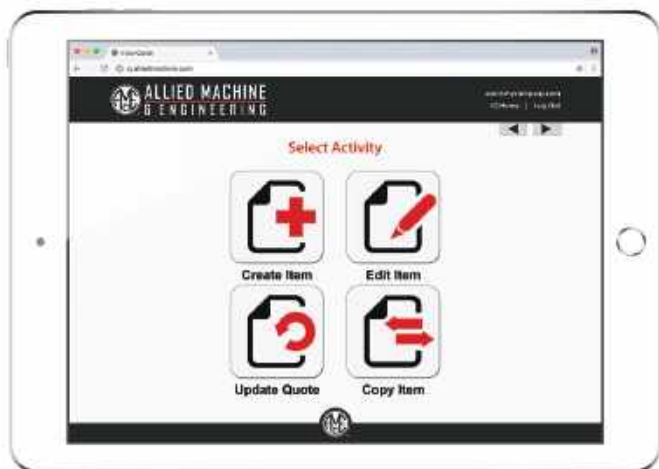

2

Select Activity

On this screen, you can choose to create a new tool, edit a previous tool, update your quote, or copy a previous item.

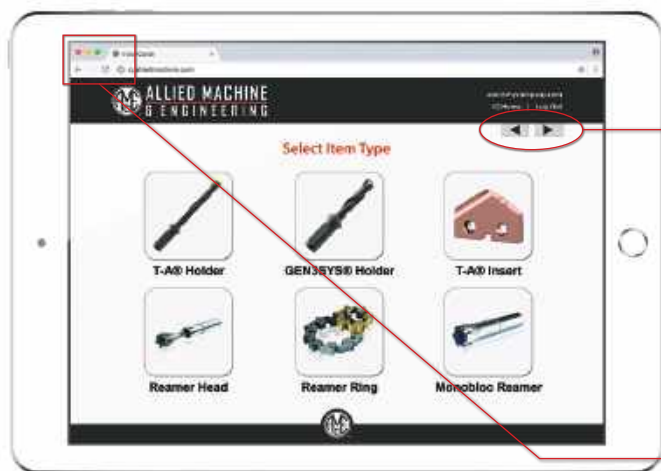

3

Select Tool Type

Choose the type of special tool you would like to create. The options include T-A® inserts, T-A® holders, GENSYS® holders, replaceable head reamers, monobloc reamers, and cutting ring reamers.



IMPORTANT:

The right and left arrows will navigate you through each step. **DO NOT** use the web browser's back and forward buttons; doing so may result in loss of progress.

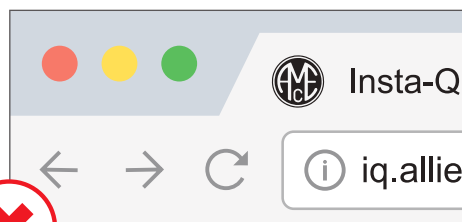

Do not use the web browser's back and forward arrows

What Is My Item Number?

As soon as you select the type of product you want to design, Insta-Quote automatically generates the item number for your tool. The item number will appear at the top left-hand side of your screen.

170209-547

Year Month Day Reference No.



4

Shank Selection

Select the shank type you require and then click the right arrow button ► to proceed.



5

Shank Options

After choosing the shank type, you will be provided with additional shank options (if applicable). Once your selections are made, click the right arrow button ► to proceed.

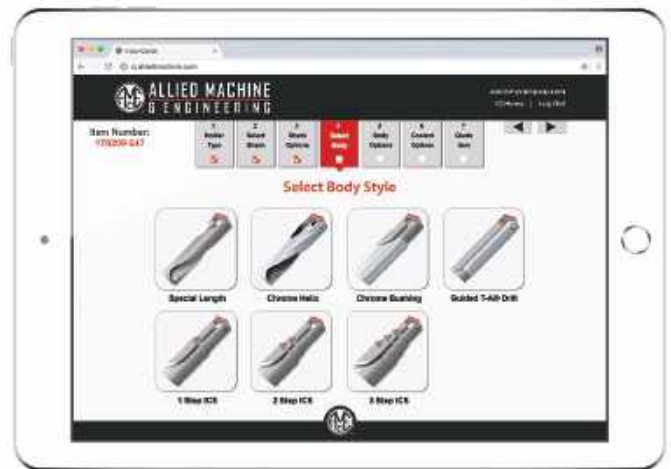

6

Select Body Style

Choose the holder style you need, and then click the right arrow button ► to proceed.



7

Body Options

After choosing the holder style, you will be provided with additional holder options (if applicable). Once your selections are made, click the right arrow button ► to proceed.



8

Coolant Options

On this screen you will select your coolant options. When finished, click the right arrow button ► to proceed.

A DRILLING

B BORING

C REAMING

D BURNISHING

E THREADING

X SPECIALS



9 **Contact Information**
Complete the contact details and select a language for the drawing. Click the "Quote Item" button to proceed.

10 **Quote Your Item**
Once you have selected "Quote Item," a box will appear to let you know the estimated time remaining before your quote and drawing are created (typical wait time is less than 1 minute).
NOTE: Your pop-up blocker must be disabled in order to view the downloaded files.

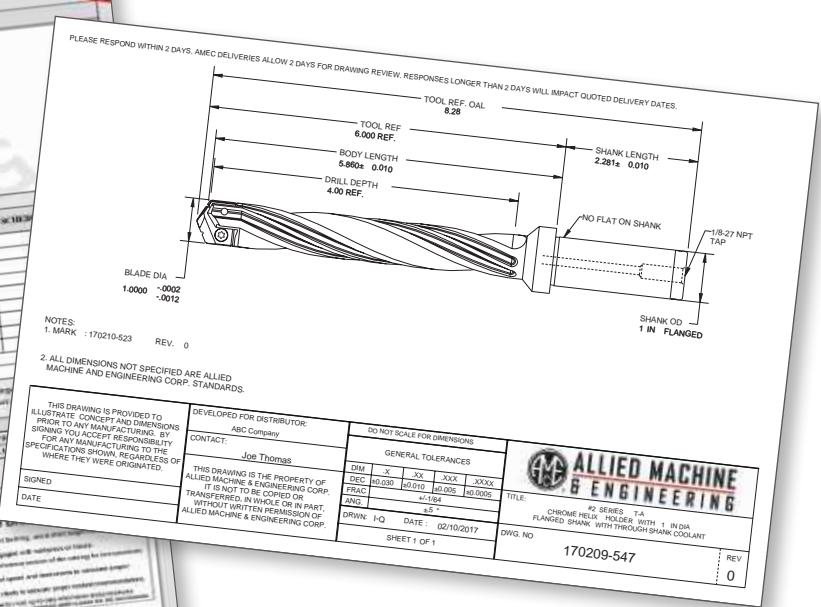
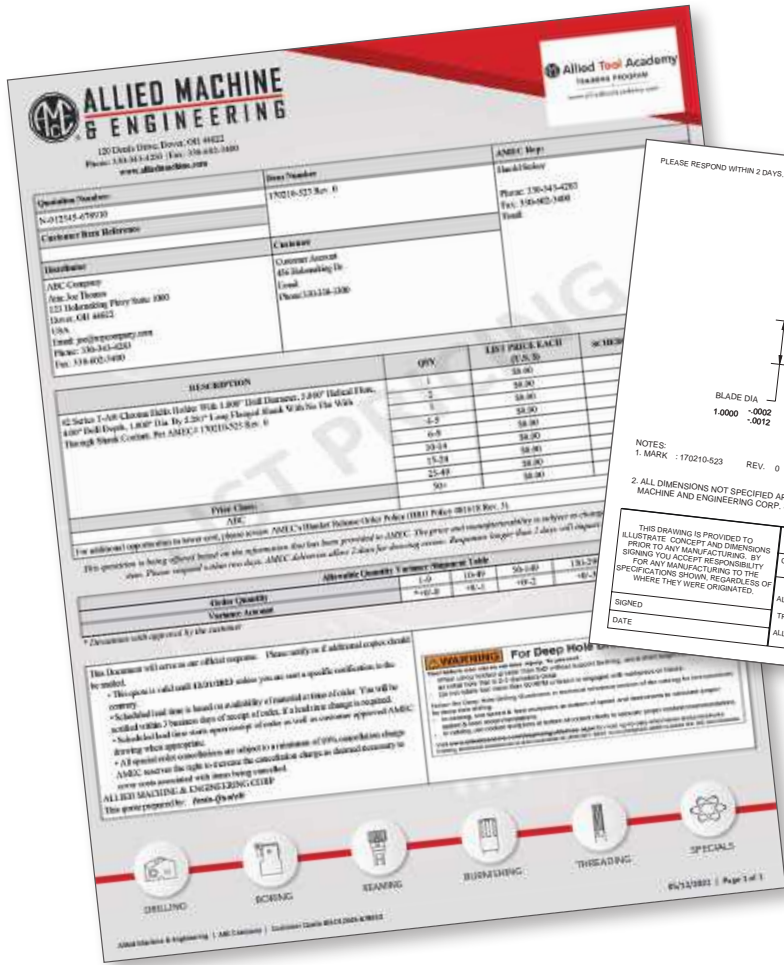

The drawing contains all relevant dimensions. It must be signed before manufacturing can begin.
NOTE: The drawing is a generic representation and is not to scale.

A DRILLING
B BORING
C REAMING
D BURNISHING
E THREADING
SPECIALS

Insta-Quote® Custom Tooling

T-A® Inserts

A
DRILLING
B
BORING
C
REAMING
D
URNISHING
E
HREADING
X
PECIALS



Special Angle



Double Angle



Spur Point



Spot and Chamfer



Step Insert



Flat Bottom



Ball Nose

Insta-Quote®

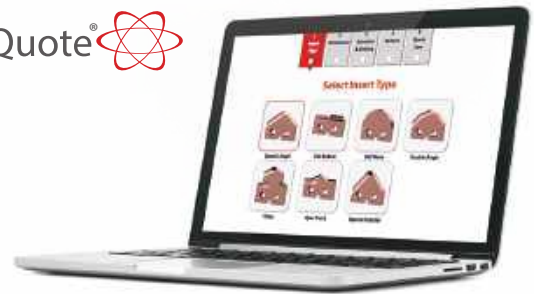



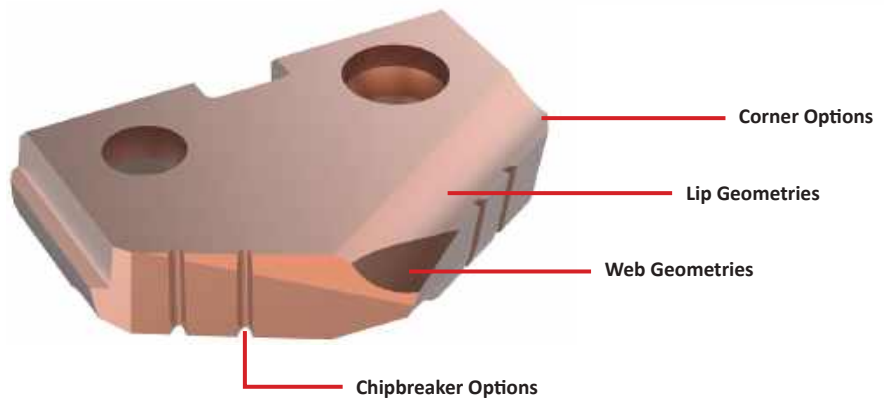

Additional Features

Insta-Quote provides multiple options to enhance different areas of the insert. If you have questions about which options would most benefit your application, just give us a call. We'll be happy to provide in-depth explanations about how certain options can optimize your results.



Substrate Options
HSS: HSS, Super Cobalt, Premium Cobalt
Carbide: C1, C2, C3, C5

Coating Options			
AM200® 	TiN 	TiAlN 	TiCN 

Insta-Quote® Custom Tooling

T-A® Holders



Chrome Helix



Chrome Bushing



 Guided Holder



One Step ICS



Two Step ICS



Three Step ICS



 Special Length

Insta-Quote® 

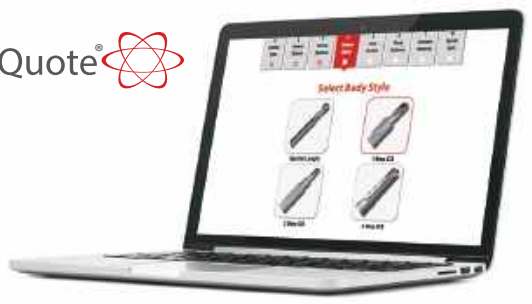

Additional Features

Insta-Quote provides multiple options to enhance different parts of the holder. If you have questions about which options would most benefit your application, just give us a call. We'll be happy to provide in-depth explanations about how certain options can optimize your results.



WARNING Refer to Speed and Feed charts for recommended adjustments to speeds and feeds. Refer to page X: 26 for deep hole drilling guidelines in this section of the catalog. Visit www.alliedmachine.com/DeepHoleGuidelines for the most up-to-date information and procedures. Factory technical assistance is available for your specific applications through our Application Engineering Team.

Insta-Quote® Custom Tooling

GEN3SYS® XT Holders

A DRILLING
B BORING
C REAMING
D BURNISHING
E THREADING
X SPECIALS



Chrome Helix



Chrome Bushing



⚠ Special Length



One Step ICS



Two Step ICS



Three Step ICS

Additional Features

Insta-Quote provides multiple options to enhance different parts of the holder. If you have questions about which options would most benefit your application, just give us a call. We'll be happy to provide in-depth explanations about how certain options can optimize your results.

Insta-Quote® 

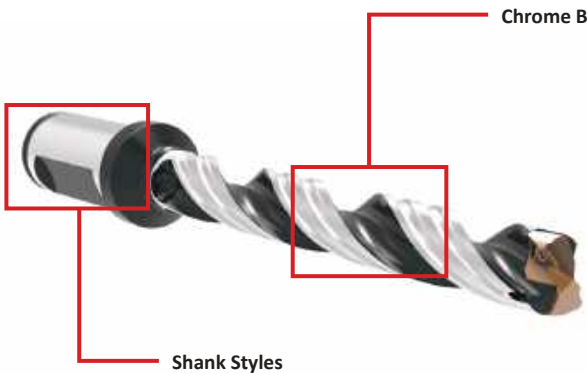
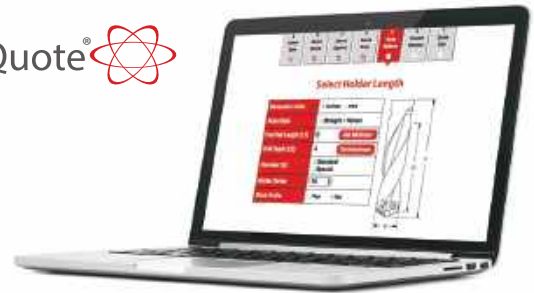

Chrome Bearing Areas

Shank Styles

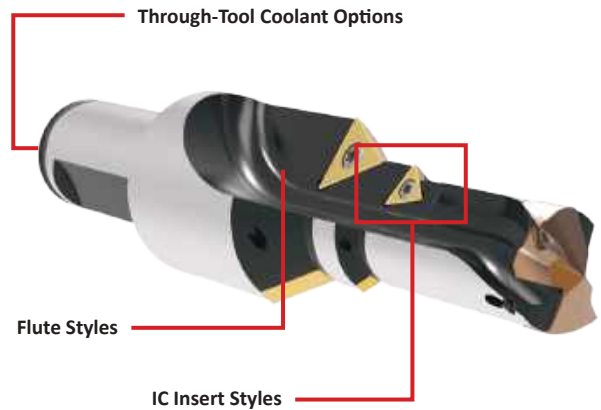

Through-Tool Coolant Options

Flute Styles

IC Insert Styles

Where are the Inserts?

Though Insta-Quote incorporates special designs for GEN3SYS XT holders, it does not include options for designing special GEN3SYS XT inserts. GEN3SYS XT holders utilize standard GEN3SYS XT inserts, which can be found in Section A20 of the product catalog.

If you need a special insert or would simply like to discuss options for designing one to fit your application, please contact us, and we can create a special design as an engineered special.



Engineered Special
GEN3SYS XT insert designed for specific aerospace application

⚠ WARNING Refer to Speed and Feed charts for recommended adjustments to speeds and feeds. Refer to page X: 26 for deep hole drilling guidelines in this section of the catalog. Visit www.alliedmachine.com/DeepHoleGuidelines for the most up-to-date information and procedures. Factory technical assistance is available for your specific applications through our Application Engineering Team.

Insta-Quote® Custom Tooling

ALVAN® Reamers















Use Insta-Quote to Build Your Part Numbers

Insta-Quote can help you find or build the ALVAN® Reamer item numbers you need along with the price and delivery of the items. It can also give you the recondition item and delivery. Just follow the steps, and Insta-Quote will guide you through the process.











Insta-Quote® 













Replaceable Head Style

Diameter/Series Options		Flute Options	Coating Options			
Expandable Diameter   5000 Series 7000 Series		 Straight  Right-Hand Helical  Left-Hand Helical	    Uncoated TiN TiCN TiAlN			
Fixed Diameter   7000 Series 9000 Series			    Alcrona Hardcut R coating T coating			

Monobloc Style

Flute Options	Coating Options			
 Straight  Left-Hand Helical	Uncoated 	Alcrona 		
	TiN 	Hardcut 		
	TiCN 	R coating 		
	TiAlN 	T coating 		

Cutting Ring Style

Flute Options	Coating Options			
 Straight  Left-Hand Helical	 Uncoated	 TiN	 TiCN	 TiAlN
	 Alcrona	 Hardcut	 R coating	 T coating

Engineered Specials

Insert Designs

OUR SOLUTION

T-A® PCD Drill Insert



- C3 carbide substrate increases tool life.
- PCD tip is specifically designed for carbon reinforced polymer (CFRP) material.
- Notch Point® geometry, special corner clip, and drill point angle help minimize delamination upon exiting the hole.

YOUR ADVANTAGE

Take control of carbon fiber reinforced polymer applications. The T-A PCD drill insert can provide the hole quality you need to produce successful quality parts and reduce scrap.

Polycrystalline Diamond Insert

What allows the polycrystalline diamond (PCD) insert to generate such high success in aerospace carbon fiber is the sharp cutting edge that provides clearance cutting and reduces delamination. The PCD wafers improve the wear resistance.

While other tools encounter massive tearing when exiting the hole in carbon fiber, the PCD insert geometry, along with precise OD corner prep and Notch Point® technology, encounters minimal delamination. This produces a near-perfect, tight tolerance and smooth hole.

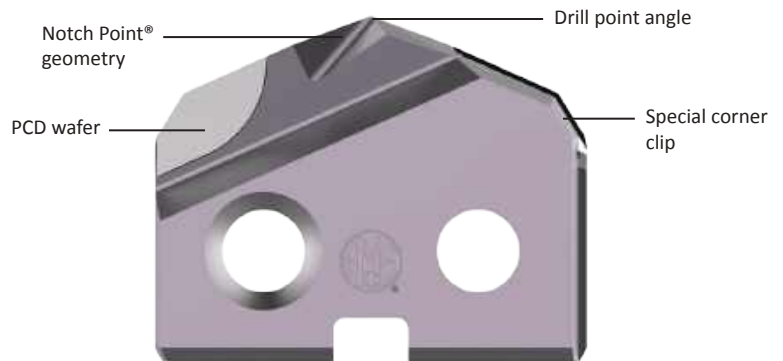

The Proof is in the Numbers

See the following results from a customer who was experiencing difficulty when drilling CFRP material:

INCREASED tool life by **700%**

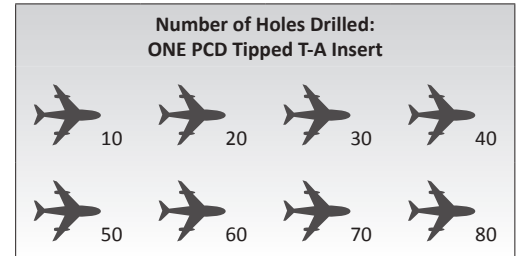
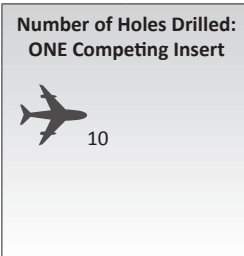

Infinite Solutions

Though Insta-Quote® and i-Form are incredible special tooling systems, some applications require a deeper level of engineering to accomplish the optimal results. No matter what the application may be, Allied Machine engineers have the knowledge, experience, and expertise to design and develop a special product to exceed your expectations.

Engineered Specials are not limited to T-A® or GEN3SYS® XT products. In fact, Engineered Specials can be created for most products offered by Allied Machine, including APX™ Drill, Opening Drill®, AccuThread® 856, Wohlhaupter® boring products, and many other product families.



Back Chamfer without Chip Breakers



Back Chamfer with Chip Breakers



Noncenter Cutting and Chamfer



Special Inverted Coring Geometry



Flat Bottom with Pilot, Corner Radius, and Chamfer



Multiple Step



Special Step



Special Point



Special Counterbore Step



Special Corner Radius

Engineered Specials

Featured Design | GEN3SYS® XT Vacuum Drill



The GEN3SYS XT® Vacuum Drill allows you to reap the productivity benefits of the GEN3SYS® XT outside of a fixed-position machine tool. The Vacuum Drill technology attaches to a hose to remove material that flows through the internal flute of the drill. This versatile ability allows the drilling process to move from location to location, performing operations on large components.

The design of the GEN3SYS® XT insert increases penetration rates, which can lower your production time and decrease operation costs. Available in multiple material-specific geometries, the GEN3SYS® XT has a solution for most applications.

A
DRILLING
B
BORING
C
REAMING
D
BURNISHING
E
THREADING
X
SPECIALS

OUR SOLUTION

GEN3SYS® XT Vacuum Drill



- Spent coolant and chips are evacuated through an internal flute.
- Guided body diameter to run through a drill bushing.
- Replaceable tip for quick and easy insert change.

YOUR ADVANTAGE

The sealed vacuum system lets you move your drilling operations outside the confines of a machine, allowing you to increase productivity on massive components.

MATERIAL TIPS

Drilling in CFRP (Carbon Fiber Reinforced Polymer)

- These applications are run with the vacuum only (no coolant).
- Can be run with or without a micro peck cycle.

Drilling in Metal

- These applications are run with the vacuum and coolant or mist.
- Recommended to be run with a micro peck cycle.

 Materials remain contained in a sealed vacuum system.

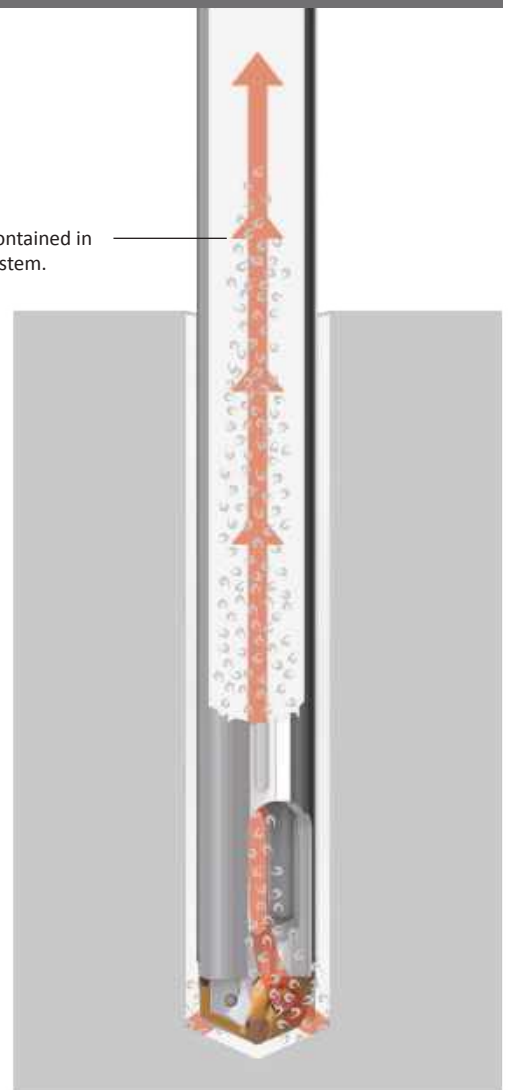

 The same holder can be used for a range of diameters.

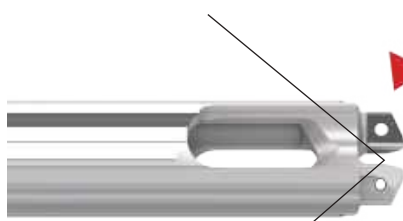

 The same holder can be used for different material-specific inserts.

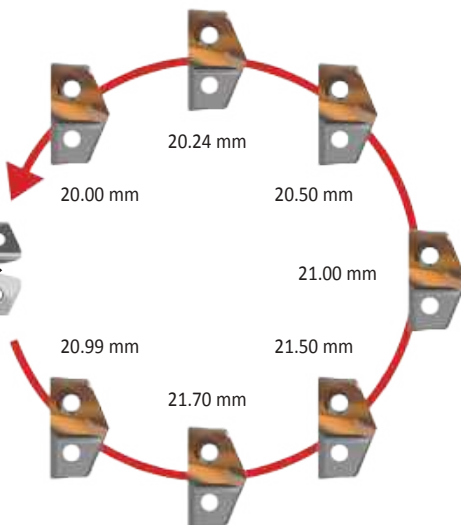

Engineered Specials

Featured Design | Guided T-A®

A
B
C
D
E
X
DRILLING
BORING
REAMING
BURNISHING
THREADING
SPECIALS



Guided T-A Highlights

- Two adjustable Torx® PLUS screw pins allow for diameter adjustment to reduce TIR.
- Provides improved tool life and hole finish.
- Guided wear pads improve hole straightness.
- Coolant-through design with multiple coolant outlets along the drill holder provides stability in deep hole drilling applications and also improves chip evacuation.



Industry Application
Automotive



Industry Application
Aerospace

Triple Coolant Outlets

- Additional coolant outlets help keep the holder straight and precise.
- Longer holders experience and maintain increased stability in deeper holes.

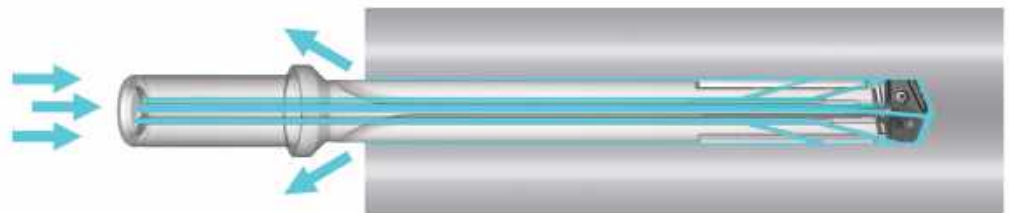

Locate the two adjustable Torx® PLUS screws (one on each side).



Loosen each screw.



Adjust insert position.

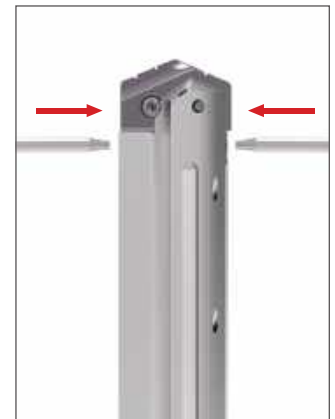

Tighten each screw.

The Proof is in the Numbers

The following results came from a real-life application that utilized the Guided T-A. The customer was experiencing a high scrap rate and needed to find a solution to eliminate the problem.

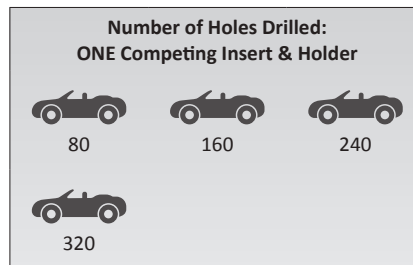

In this application, Allied Machine:

- Eliminated **\$240,000** in scrap per year.
- Optimized the chip formation.
- Enhanced the chip evacuation.
- Provided excellent surface finish.

INCREASED tool life by
280%

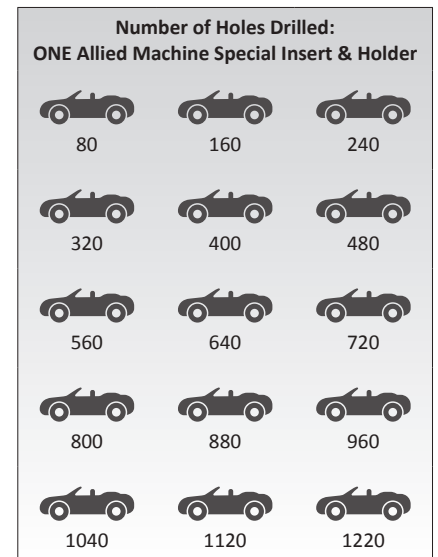

Engineered Specials

Success Stories

Real-Life Results

Below are five brief success stories. Each one provides an overview of specific situations when our special tooling achieved top-quality performance for our customers. For more in-depth case studies, go to www.alliedmachine.com/RealLifeResults.



Industry Application

Oil & Gas

Special AccuPort 432® Port Contour Cutter

Hydraulic Manifolds

- Eliminated multiple tools in the process.
- Eliminated regrinds.
- Improved performance in cross hole applications.



Industry Application

Heavy Equipment

Special T-A® Holder & Insert

Axle Shafts

- 100% increase in tool life.
- \$7,500 reduction in setup costs.
- Eliminated scrap that was caused by setup issues.



Industry Application

Firearms

i-Form Drill

Barrel Nut

- Eliminated three tools in the process.
- Reduced cycle time by 25%.
- Improved chip formation.



Industry Application

Automotive

T-A® Rim Drill

Aluminum Wheels

- 50% increase in penetration rates.
- 50% increase in tool life.
- Eliminated regrinds.



Industry Application

Aerospace

Special Carbide Clad T-A® Holder with Diamond Coated Insert

Carbon Fiber Landing Arm

- Eliminated delamination of carbon fiber.
- 7x more tool life.
- Special shank threads directly into drill unit for easy tool change.



Engineered Specials

i-Form Custom Indexable Drill / Form Tool System

Any Way You Want It

What if you could utilize complex forms that only seem to be available as brazed or solid carbide tools? Allied Machine's i-Form custom indexable drill/form tool system allows for complex designs with a replaceable cutting edge. This will reduce setup times and eliminate regrinds, allowing you to increase your productivity and reduce costs. Don't settle for being good when the possibility of being great is right in front of you.

This is just a small sample of what you can do.



**i-Form Holder
with i-Form Inserts**



**Lug Hole T-A® Drill
with i-Form Inserts**



**i-Form Drill for Facing Operations
with ID-OD Chamfer**

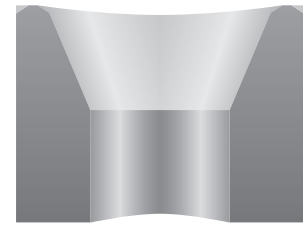
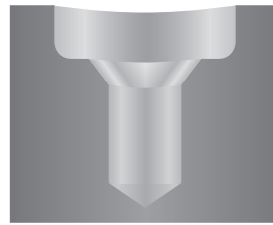
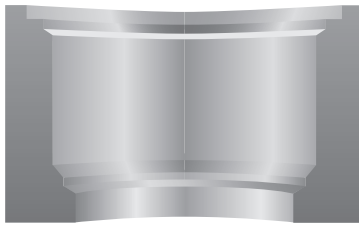

Design Complex Forms for ANY Hole Style

i-Form allows you to design complex forms for any style hole with increased productivity. The i-Form product line - both pilot inserts and form inserts - creates custom engineered forms that provide complex designs with replaceable cutting edges and improved consistency, all while outperforming brazed and solid carbide tooling. i-Form tools will increase your productivity, minimize setup times, and eliminate regrind tool float and inconsistency.

- Holders have coolant-through capabilities.
- Holders can utilize standard inserts, Insta-Quote® inserts, and/or special insert designs.

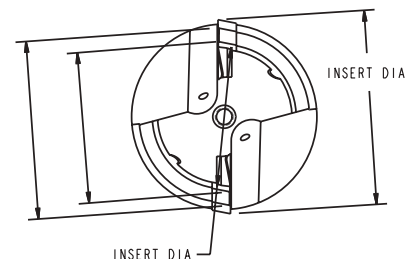
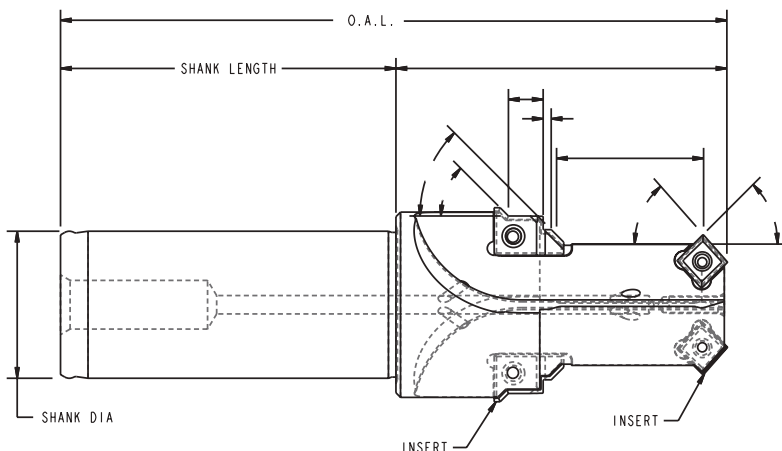

Engineered Specials

i-Form Custom Indexable Drill / Form Tool System



**GEN3SYS® XT Pilot Insert
with i-Form Inserts**



**GEN3SYS® XT Pilot Insert
with i-Form Inserts**



**GEN3SYS® XT Back Chamfer Insert
with ISO Inserts**



**T-A® Flat Bottom Form Drill
with i-Form Inserts**



**T-A® ICS Drill
with i-Form Inserts**



**T-A® Pilot Insert
with i-Form Inserts**



**Square QDSI 34™ Inserts
with i-Form Inserts**



**3 Flute IC Drill
with i-Form Inserts**



**i-Form Holder
with i-Form Inserts**



**AccuPort 432® Drill
with Special T-A® Form Insert**



**T-A® 2 Step IC Drill
with i-Form Inserts**



**Special Core Drill
with i-Form Inserts**

A
DRILLING
B
BORING
C
REAMING
D
BURNISHING
E
THREADING
X
SPECIALS

Engineered Specials

Special Designs | T-A® Products

A
DRILLING
B
BORING
C
REAMING
D
BURNISHING
E
THREADING
X
SPECIALS



**T-A IC Drill
with Back Chamfer Insert**



T-A 1 Step Stub Length



T-A IC Drill



T-A 2 Step IC Drill



**T-A Counter Bore Tool
with Micro Adjustable Cartridge**



**T-A Form Drill
with Adjustable Cartridge**



**T-A Multiple Step Drill
with Adjustable Cartridge**



**T-A Large Diameter
Multiple Step IC Drill**



T-A Deburr Drill



**T-A IC Drill
with Customer Defined Shank**



**T-A Deep Hole Drill
with Customer Defined Design**



**T-A Chrome Bearing Drill
with Customer Defined Shank**



**T-A 1 Step IC Drill
with Flat Bottom Insert**



T-A Form Drill



**T-A Drill
with Special Holder and Insert Design**

Engineered Specials

Special Designs | Other Products



**Special BT-A Drill
with Internal Thread**



Special BT-A Drill



Special BT-A Drill



**APX™ Drill
with Carbide Clad Guides**



**APX™ Drill
with 1 Step Design**



**APX™ Drill
with HSK Shank**



**Opening Drill®
with Special Diameter**



**Special Core Drill
with 2 Step Design**



**ICS Drill
with Adjustable Cartridge**



**Superior® Solid Carbide
with AM200® Coating**



**AccuThread® 856
with Through Coolant**



**AccuPort 432®
Special Length**



**ALVAN® Ring Style Reamer
with Special Length**



**GEN3SYS® XT
with Morse Taper Shank**



**GEN3SYS® XT
with IC Inserts and Special Body**



A
DRILLING
B
BORING
C
REAMING
D
BURNISHING
E
THREADING
X
SPECIALS

QDSI 34™ Inserts

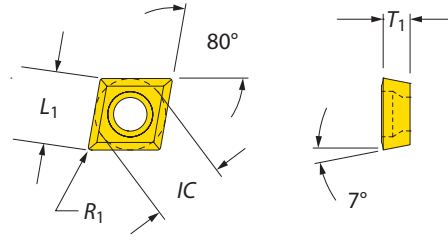
80° Diamond | 55° Diamond





80° Diamond Inserts

Imperial (inch)				Metric (mm)					ANSI Designation		
IC	L ₁	T ₁	R ₁	IC	L ₁	T ₁	R ₁				
0.250	0.249	0.094	0.008	6.35	6.32	2.39	0.20	CCGT-060202	CCGT 2(1.5)0.5	7256-IP8-1	8IP-8
0.250	0.247	0.094	0.016	6.35	6.28	2.39	0.40	CCMT-060204	CCMT 2(1.5)1	7256-IP8-1	8IP-8
0.250	0.244	0.094	0.031	6.35	6.21	2.39	0.79	CCMT-060208	CCMT 2(1.5)2	7256-IP8-1	8IP-8
0.250	0.244	0.156	0.031	6.35	6.21	3.96	0.79	CCGT-06T308	CCGT 2(2.5)2	7256-IP8-1	8IP-8
0.375	0.374	0.156	0.008	9.53	9.49	3.96	0.20	CCGT-09T302	CCGT 3(2.5)0.5	7359-IP15-1	8IP-15
0.375	0.372	0.156	0.016	9.53	9.46	3.96	0.40	CCMT-09T304	CCMT 3(2.5)1	7359-IP15-1	8IP-15
0.375	0.369	0.156	0.031	9.53	9.39	3.96	0.79	CCMT-09T308	CCMT 3(2.5)2	7359-IP15-1	8IP-15
0.500	0.497	0.188	0.016	12.70	12.63	4.76	0.40	CCMT-120404	CCMT 431	745105-IP20-1	8IP-20
0.500	0.494	0.188	0.031	12.70	12.56	4.76	0.79	CCMT-120408	CCMT 432	745105-IP20-1	8IP-20

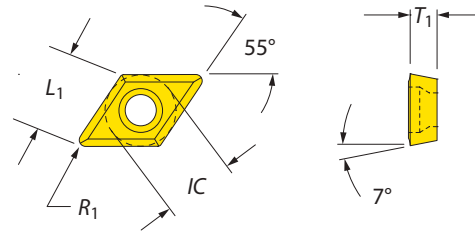
NOTE: QDSI 34 inserts are utilized only in special ICS holders. Speeds and feeds for QDSI 34 inserts are determined by drill insert.



55° Diamond Inserts

Imperial (inch)				Metric (mm)					ANSI Designation		
IC	L ₁	T ₁	R ₁	IC	L ₁	T ₁	R ₁				
0.250	0.243	0.094	0.008	6.35	6.18	2.39	0.008	DCGT-070202	DCGT 2(1.5)0.5	7256-IP8-1	8IP-8
0.250	0.237	0.094	0.016	6.35	6.01	2.39	0.016	DCMT-070204	DCMT 2(1.5)1	7256-IP8-1	8IP-8
0.250	0.223	0.094	0.031	6.35	5.67	2.39	0.031	DCMT-070208	DCMT 2(1.5)2	7256-IP8-1	8IP-8
0.375	0.362	0.156	0.016	9.53	9.19	3.96	0.016	DCMT-11T304	DCMT 3(2.5)1	7359-IP15-1	8IP-15
0.375	0.348	0.156	0.031	9.53	8.85	3.96	0.031	DCMT-11T308	DCMT 3(2.5)2	7359-IP15-1	8IP-15



NOTE: QDSI 34 inserts are utilized only in special ICS holders. Speeds and feeds for QDSI 34 inserts are determined by drill insert.

QDSI 34™ Inserts

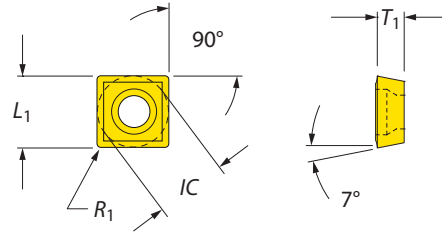
Square | 60° Triangle





Square Inserts

Imperial (inch)				Metric (mm)					ANSI Designation		
IC	L ₁	T ₁	R ₁	IC	L ₁	T ₁	R ₁	Part No.		Torx Screw	Torx® Driver
0.375	0.375	0.156	0.016	9.53	9.53	3.96	0.40	SCMT-09T304	SCMT 3(2.5)1	7359-IP15-1	8IP-15

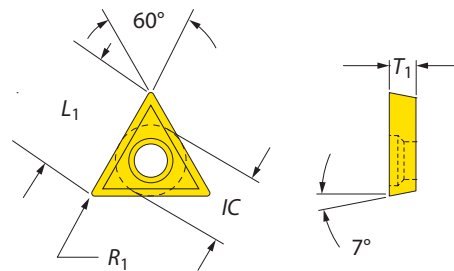
NOTE: QDSI 34 inserts are utilized only in special ICS holders. Speeds and feeds for QDSI 34 inserts are determined by drill insert.



60° Triangle Inserts

Imperial (inch)				Metric (mm)					ANSI Designation		
IC	L ₁	T ₁	R ₁	IC	L ₁	T ₁	R ₁	Part No.		Torx Screw	Torx® Driver
0.156	0.259	0.078	0.008	3.97	6.58	1.98	0.20	TCGT-06T102	TCGT 1.2(1.2)0.5	724-IP6-1	8IP-6
0.156	0.248	0.078	0.016	3.97	6.29	1.98	0.40	TCGT-06T104	TCGT 1.2(1.2)1	724-IP6-1	8IP-6
0.156	0.225	0.078	0.031	3.97	5.71	1.98	0.79	TCGT-06T108	TCGT 1.2(1.2)2	724-IP6-1	8IP-6
0.219	0.367	0.094	0.008	5.65	9.33	2.39	0.20	TCGT-090202	TCGT 1.8(1.5)0.5	7225-IP7-1	8IP-7
0.219	0.356	0.094	0.016	5.65	9.04	2.39	0.40	TCGT-090204	TCGT 1.8(1.5)1	7225-IP7-1	8IP-7
0.219	0.333	0.094	0.031	5.65	8.46	2.39	0.79	TCGT-090208	TCGT 1.8(1.5)2	7225-IP7-1	8IP-7
0.250	0.422	0.094	0.008	6.35	10.71	2.39	0.20	TCGT-110202	TCGT 2(1.5)0.5	7256-IP8-1	8IP-8
0.250	0.410	0.094	0.016	6.35	10.42	2.39	0.40	TCMT-110204	TCMT 2(1.5)1	7256-IP8-1	8IP-8
0.250	0.387	0.094	0.031	6.35	9.84	2.39	0.79	TCMT-110208	TCMT 2(1.5)2	7256-IP8-1	8IP-8
0.375	0.627	0.156	0.016	9.53	15.92	3.96	0.40	TCMT-16T304	TCMT 3(2.5)1	7359-IP15-1	8IP-15
0.375	0.604	0.156	0.031	9.53	15.34	3.96	0.79	TCMT-16T308	TCMT 3(2.5)2	7359-IP15-1	8IP-15
0.500	0.820	0.188	0.031	12.70	20.83	4.76	0.79	TCGT-220408	TCGT 432	745105-IP20-1	8IP-20

NOTE: QDSI 34 inserts are utilized only in special ICS holders. Speeds and feeds for QDSI 34 inserts are determined by drill insert.

A DRILLING
B BORING
C REAMING
D BURNISHING
E THREADING
X SPECIALS

Special Tooling

Complete Your Design

Show Us What You Need

These pages have been included so you can assist us with defining your special tooling requirements.

- Select a Shank (1 - 6), or define Shank 7.
- Indicate if the shank will be used with or without a Rotary Coolant Adapter (RCA).

We ask that you define your hole profile and offer an example of a tool form to help us with the design process. Tools 1 - 5 cover only a small portion of our capabilities, so feel free to use your imagination. Please scan these pages, record your information in the boxes on the next page, and email the information for our quickest response.

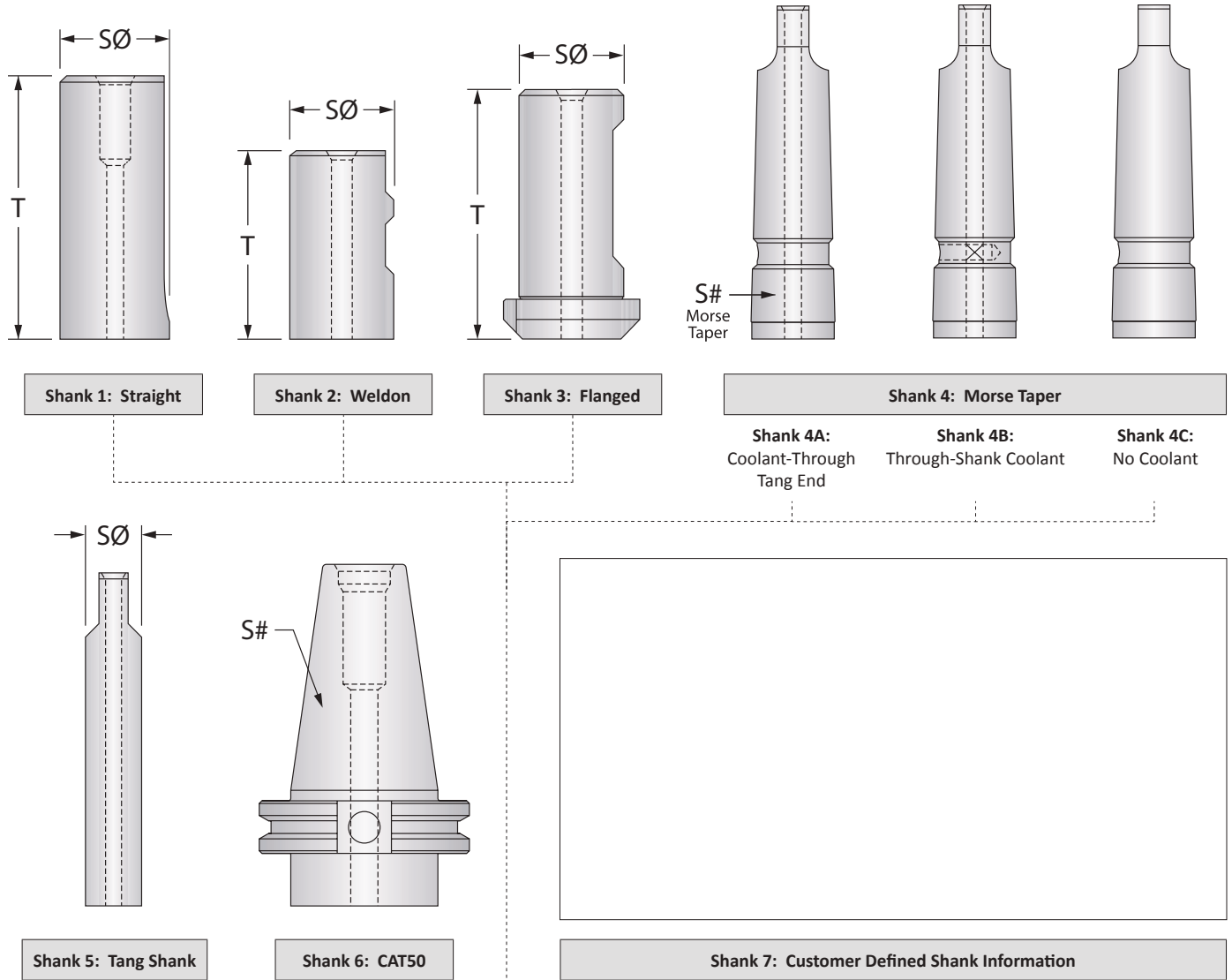

Shank	$S\emptyset$	$S\#$	T	RCA
4A (EXAMPLE)	-	4MT	-	YES <input checked="" type="radio"/> NO
				YES / NO
				YES / NO
				YES / NO

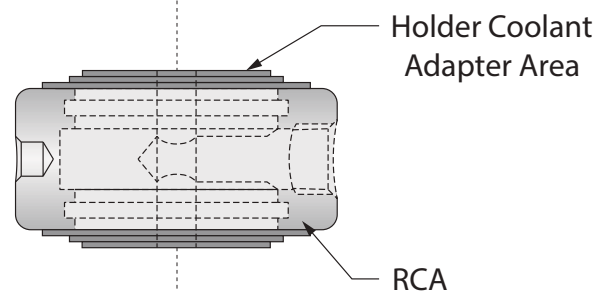

A
DRILLING
B
BORING
C
REAMING
D
BURNISHING
E
THREADING
X
SPECIALS

Tool 1

- Carbide Clad
- Chrome Plate
- Helical Flute
- Straight Flute

Tool 2

- Helical Pilot
- Chrome Pilot

Tool 3

- Helical Flute
- Straight Flute

Tool 4

- Helical Pilot
- Chrome Pilot

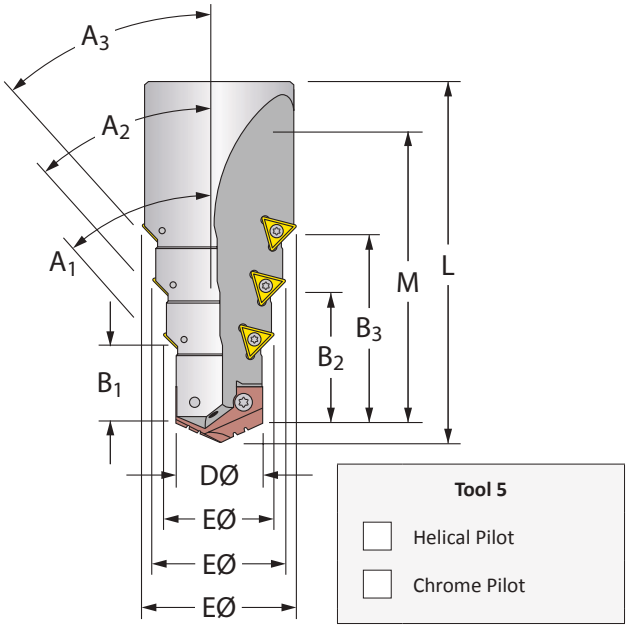
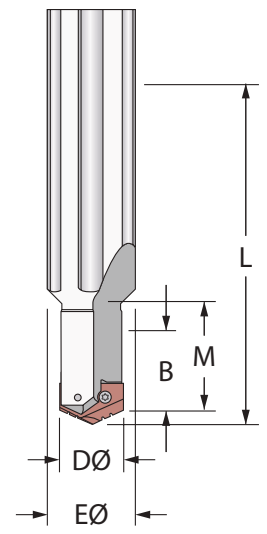
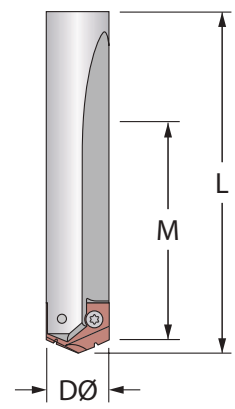
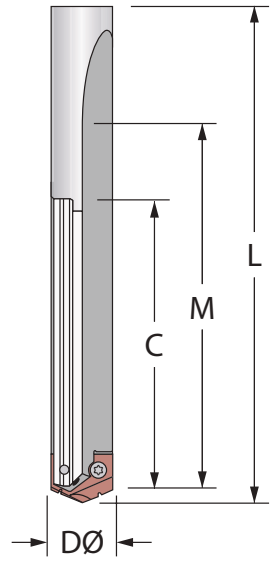
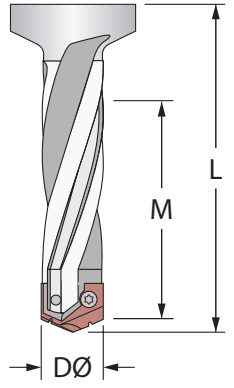

Tool 5

- Helical Pilot
- Chrome Pilot

Hole Profile

Please email or fax your design to:
 Application Engineering Department
 P: 800.321.5537 | F: 330.343.7666 | E: appeng@alliedmachine.com

Item	Tool	A ₁	A ₂	A ₃	B ₁	B ₂	B ₃	C	D Ø	E Ø	F Ø	G	L	M
EXAMPLE	5	30°	-	-	1.00	-	-	0.25	0.620	1.25	-	-	4.50	3.00

Name:		Company:	
Email:	Phone:	Distributor (if known):	
Customer Signature:			Date:

Please be sure to include shank and coolant information from the previous page when sending tool designs.

A DRILLING
 B BORING
 C REAMING
 D BURNISHING
 E THREADING
 SPECIALS



Deep Hole Drilling Guidelines

For Lengths Greater Than 9xD (including Extended, Long, XL, 3XL, and Special Length)

- 1. Pilot Hole**
100 % RPM
100% IPR (mm/rev)

Establish the pilot hole using the same diameter short drill to a depth of 2xD minimum. Utilize a pilot drill with the same or larger included point angle.

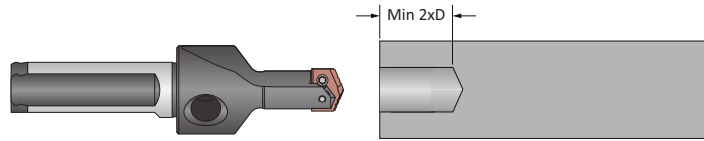

Coolant ON

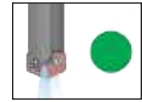

- 2. Feed-in**
50 RPM max
12 IPM (300 mm/min)

Feed the longer drill within 1/16" (1.5 mm) short of the established pilot hole bottom at a **maximum of 50 RPM** and 12 IPM (300 mm/min) feed rate.

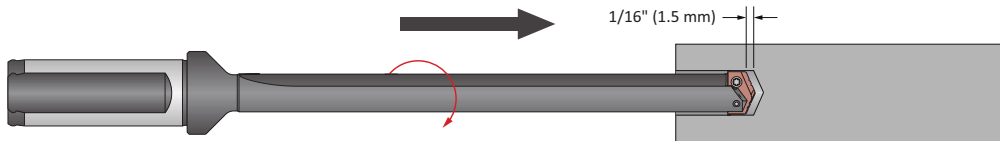

Coolant OFF

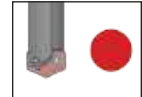

- 3. Deep Hole Transition Drilling**
50 % RPM
75% IPR (mm/rev)

Drill additional 1xD past the bottom of the pilot hole at 50% reduction of recommended speed and 25% reduction of recommended feed. Minimum of 1 second dwell is required to meet full speed before feeding.

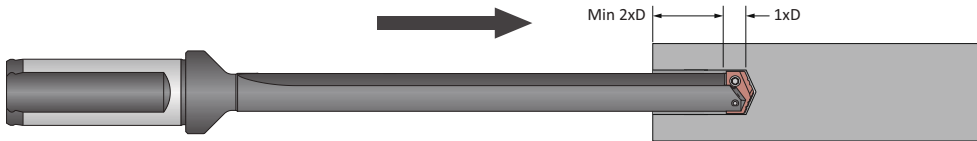

Coolant ON

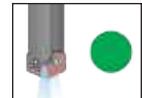

- 4. Deep Hole Drilling - Blind**
100% RPM
100% IPR (mm/rev)

Drill to full depth at recommended speed and feed for longer drill according to Allied speed and feed charts. **No peck cycle recommended.**

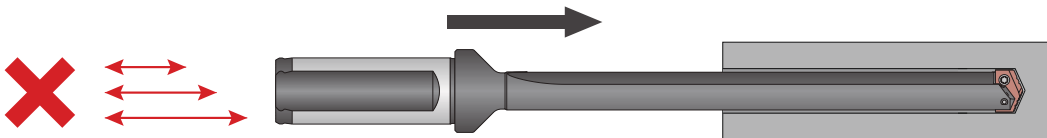

Coolant ON

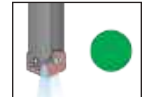

- 5. Deep Hole Drilling - at Breakout**
50% RPM
75% IPR (mm/rev)

For through holes only: Reduce speed by 50% and feed by 25% prior to breakout. Do not breakout more than 1/8" (3 mm) past the full diameter of the drill.

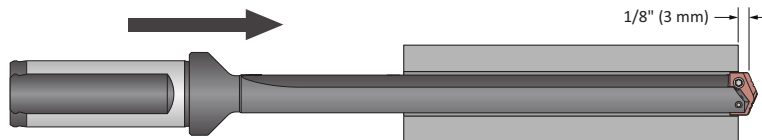

Coolant ON

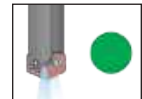

- 6. Drill Retract**
50 RPM max

Reduce speed to a **maximum of 50 RPM** before retracting from the hole.

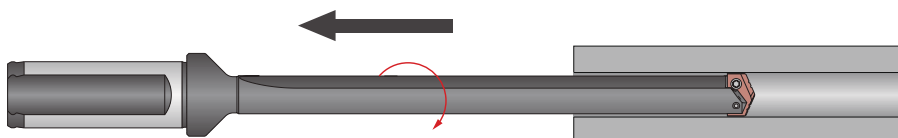

Coolant OFF

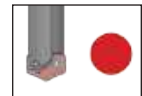

1. WARNING Tool failure can cause serious injury. To prevent:

- When using holders without support bushing, use a short holder to establish an initial hole that is a minimum of 2 diameters deep.
- Do not rotate tool holders more than 50 RPM unless it is engaged with the workpiece or fixture.

Visit www.alliedmachine.com/DeepHoleGuidelines for the most up-to-date information and procedures. Factory technical assistance is available for your specific applications through our Application Engineering Team.

Guaranteed Test / Demo Application Form

Distributor PO #

The following must be filled out completely before your test will be considered.

IMPORTANT: For processing, send purchase order to your Allied Field Sales Engineer (FSE). Please clearly mark the paperwork as "Test Order."

Distributor Information

Company Name: _____
Contact: _____
Account Number: _____
Phone: _____
Email: _____

End User Information

Company Name: _____
Contact: _____
Industry: _____
Phone: _____
Email: _____

Current Process List all tooling, coatings, substrates, speeds and feeds, tool life, and any problems you are experiencing.

Test Objective List what would make this a successful test (i.e. penetration rate, finish, tool life, hole size, etc.).

Application Information

Hole Diameter: _____ in/mm Tolerance: _____ Material: _____
(4150, A36, cast iron, etc.)
Preexisting Diameter: _____ in/mm Depth of Cut: _____ in/mm Hardness: _____
(BHN, Rc)
Required Finish: _____ RMS State: _____
(Casting, hot rolled, forging)

Machine Information

Machine Type: _____ Builder: _____ Model #: _____
(Lathe, screw machine, machine center, etc.) (Haas, Mori Seiki, etc.)
Shank Required: _____ Power: _____ HP/KW
(CAT50, Morse taper, etc.)
Rigidity: Orientation: Tool Rotating: Thrust: _____ lbs/N
 Excellent Vertical Yes
 Good Horizontal No
 Poor

Coolant Information

Coolant Delivery: _____ Coolant Pressure: _____ PSI / bar
(Through tool, flood)
Coolant Type: _____ Coolant Volume: _____ GPM / LPM
(Air mist, oil, synthetic, water soluble, etc.)

Requested Tooling

QTY	Item Number

QTY	Item Number



Allied Machine & Engineering
120 Deeds Drive
Dover, OH 44622

Telephone: (330) 343-4283
Toll Free USA & Canada: (800) 321-5537
Email: info@alliedmachine.com

Warranty Information



Allied Machine & Engineering ("Allied Machine") warrants to original equipment manufacturers, distributors, industrial and commercial users of its products for one year from the original date of sale that each new product manufactured or supplied by Allied Machine shall be free from defects in material and workmanship.

Allied Machine's sole and exclusive obligation under this warranty is limited to, at its option, without additional charge, replacing or repairing this product or issuing a credit. For this warranty to be applied, the product must be returned freight prepaid to the plant designated by an Allied Machine representative and which, upon inspection, is determined by Allied Machine to be defective in material and workmanship.

Complete information as to operating conditions, machine, setup, and the application of cutting fluid should accompany any product returned for inspection. This warranty shall not apply to any Allied Machine products which have been subjected to misuse, abuse, improper operating conditions, improper machine setup or improper application of cutting fluid or which have been repaired or altered if such repair or alteration, in the judgement of Allied Machine, would adversely affect the performance of the product.

THIS WARRANTY IS IN LIEU OF ALL OTHER WARRANTIES, EXPRESS OR IMPLIED, INCLUDING ANY IMPLIED WARRANTY OF MERCHANTABILITY OR FITNESS FOR A PARTICULAR PURPOSE. Allied Machine shall have no liability or responsibility for any claim, whether in contract, tort or otherwise, for any loss or damage arising out of, connected with, or resulting from the manufacture, sale, delivery or use of any product sold hereunder, in excess of the cost of replacement or repair as provided herein.

Allied Machine shall not be liable in contract or in tort (including, without limitation, negligence, strict liability or otherwise) for economic losses of any kind or for any special, incidental, indirect, consequential, punitive or exemplary damages arising in any way out of the performance of, or failure to perform this agreement.

ALL PRICES, DELIVERIES, DESIGNS, AND MATERIALS ARE SUBJECT TO CHANGE WITHOUT NOTICE.



Allied Machine & Engineering is registered to ISO 9001:2015 by DQS.



Wohlhaupter GmbH is registered to ISO 9001:2015 by QUACERT.



Allied Machine & Engineering Co. Europe Ltd. is registered to ISO 9001:2015 by bsi.

United States

Allied Machine & Engineering

120 Deeds Drive
Dover OH 44622
United States

Phone:

+1.330.343.4283

Toll Free USA and Canada:

800.321.5537

Toll Free USA and Canada:

800.223.5140

Allied Machine & Engineering

485 W Third Street
Dover OH 44622
United States

Phone:

+1.330.343.4283

Toll Free USA and Canada:

800.321.5537

Europe

Allied Machine & Engineering Co. (Europe) Ltd

93 Vantage Point
Pensnett Estate
Kingswinford
West Midlands
DY6 7FR England

Phone:

+44 (0) 1384 400 900

Wohlhaupter® GmbH

Maybachstrasse 4
Postfach 1264
72636 Frickenhausen
Germany

Phone:

+49 (0) 7022 408-0

Asia

Wohlhaupter® India Pvt. Ltd.

B-23, 3rd Floor
B Block Community Centre
Janakpuri, New Delhi - 110058
India

Phone:

+91 (0) 11.41827044

Your local Allied Machine representative:

www.alliedmachine.com

Allied Machine & Engineering is registered to **ISO 9001:2015** by DQS.

Wohlhaupter GmbH is registered to **ISO 9001:2015** by QUACERT.

Allied Machine & Engineering Co. (Europe) Ltd is registered to **ISO 9001:2015** by bsi.

