



**ALLIED MACHINE
& ENGINEERING**

Holemaking Solutions for Today's Manufacturing



Boring



Reaming

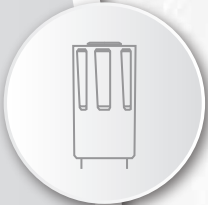

Burnishing



Threading

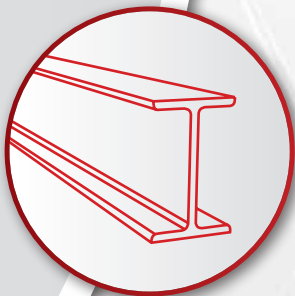

Specials



Structural Steel Solutions

► *DRILLING*

Replaceable Insert & Indexable Drills

SECTION

A91

Structural Steel Solutions

Structural Steel Drilling Solutions

T-A® and GEN2 T-A® | GEN3SYS® XT Pro | 4TEX® Drill

- ▶ **T-A® and GEN2 T-A® Diameter Range:** 0.5512" - 1.8829" (14.00 mm - 47.82 mm)
- ▶ **GEN3SYS® XT Pro Diameter Range:** 0.4724" - 1.3780" (12.00 mm - 35.00 mm)
- ▶ **4TEX® Drill Diameter Range:** 0.472" - 1.562" (12.00 mm - 39.67 mm)*

*See the 4TEX Drill catalog (A55-4TX) for all diameters available.



Take on Tough Drilling

Allied Machine's structural steel drilling system is designed for maximum performance in structural steel materials and applications. These solutions utilize the T-A, GEN2 T-A, GEN3SYS XT Pro, and 4TEX drill designs and capabilities.

With multiple geometries and coatings, you're sure to find the solution that is right for you. Tough drilling is tough no more.

Your safety and the safety of others is very important. This catalog contains important safety messages. Always read and follow all safety precautions.



This triangle is a safety hazard symbol. It alerts you to potential safety hazards that can cause tool failure and serious injury.

When you see this symbol in the catalog, look for a related safety message that may be near this triangle or referred to in the nearby text.

There are safety signal words also used in the catalog. Safety messages follow these words.

WARNING

WARNING (shown above) means that failure to follow the precautions in this message could result in tool failure and serious injury.

NOTICE means that failure to follow the precautions in this message could result in damage to the tool or machine but not result in personal injury.

NOTE and **IMPORTANT** are also used. These are important that you read and follow but are not safety-related.

Visit www.alliedmachine.com for the most up-to-date information and procedures.

Excellent chip control

Improves hole quality and surface finish

Provides maximum durability and stability

Applicable Industries



Structural Steel

Structural Steel Drilling Solutions Contents

T-A® and GEN2 T-A® Drilling System

T-A and GEN2 T-A System Overview	2 - 4
Nomenclature	5
0 Series	6 - 9
1 Series	10 - 13
2 Series	14 - 17
3 Series	18 - 20
Deep Hole Drilling Guidelines	21

GEN3SYS® XT Pro System

GEN3SYS XT Pro System Overview	22
Product Nomenclature	23
12 - 13 Series	24 - 25
14 - 15 Series	26 - 27
16 - 17 Series	28 - 29
18 - 20 Series	30 - 31
22 - 24 Series	32 - 33
26 - 29 Series	34 - 35
32 Series	36

4TEX® Drill System

Safety Information	38
4TEX Overview	39 - 42
Product Nomenclature	43
03 Series	44
04 Series	45
05 Series	46 - 47
06 Series	48 - 49
07 Series	50 - 51
09 Series	52 - 53
11 Series	54 - 55
14 Series	56 - 57
Eccentric Sleeves	58
Diameter Adjustment	59
Center Height Alignment	60 - 61

Recommended Cutting Data

T-A and GEN2 T-A System	62 - 63
GEN3SYS XT Pro System	64 - 65
4TEX Drill System	66
4TEX Drill Insert Recommendations Troubleshooting	67

Reference Icons

The following icons will appear throughout the catalog to help you navigate between products.

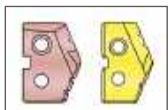

Corresponding T-A & GEN2 T-A Inserts

Refers to the corresponding T-A insert items that connect with each specific holder series

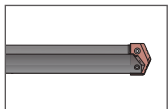

Corresponding T-A Holders

Refers to the corresponding T-A holder items that connect with each specific insert series



Setup / Assembly Information

Detailed instructions and information regarding the corresponding part(s)

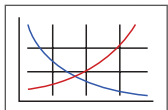

Recommended Cutting Data

Speed and feed recommendations for optimum and safe drilling

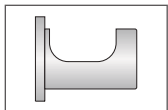

Eccentric Sleeves

Refers to the corresponding eccentric sleeve for the holder



Coolant-Through Option

Indicates that the product is coolant through

Series	T-A® and GEN2 T-A® Diameter Range	
	Imperial (inch)	Metric (mm)
0	0.5512 - 0.6959	14.00 - 17.67
1	0.6900 - 0.9609	17.53 - 24.40
2	0.9610 - 1.3809	24.41 - 35.06
3	1.3530 - 1.8829	34.37 - 47.82

Series	GEN3SYS® XT Pro Diameter Range	
	Imperial (inch)	Metric (mm)
12	0.4724 - 0.5117	12.00 - 12.99
13	0.5118 - 0.5511	13.00 - 13.99
14	0.5512 - 0.5905	14.00 - 14.99
15	0.5906 - 0.6298	15.00 - 15.99
16	0.6299 - 0.6692	16.00 - 16.99
17	0.6693 - 0.7086	17.00 - 17.99
18	0.7087 - 0.7873	18.00 - 19.99
20	0.7874 - 0.8660	20.00 - 21.99
22	0.8661 - 0.9448	22.00 - 23.99
24	0.9449 - 1.0235	24.00 - 25.99
26	1.0236 - 1.1416	26.00 - 28.99
29	1.1417 - 1.2597	29.00 - 31.99
32	1.2598 - 1.3780	32.00 - 35.00

Series	4TEX® Drill Diameter Range*	
	Imperial (inch)	Metric (mm)
03	0.472 - 0.512	12.00 - 13.00
04	0.551 - 0.591	14.00 - 15.00
05	0.625 - 0.709	15.88 - 18.00
06	0.748 - 0.827	19.00 - 21.00
07	0.866 - 1.024	22.00 - 26.00
09	1.063 - 1.250	27.00 - 31.75
11	1.260 - 1.500	32.00 - 38.10
14	1.535 - 1.562	39.00 - 39.67

*See the 4TEX drill catalog (A55-4TX) for all diameters available.







Structural Steel Drilling

Achieving Optimal Results in Structural Steel

Drilling in structural steel materials can be a difficult process, and achieving optimal results becomes a major issue. Allied Machine's structural steel drilling solutions have been specifically designed to produce the best results in the toughest materials. With solutions in both the T-A® and GEN3SYS® XT Pro product lines, you have multiple options to solve your application problems.



Insert Style Comparison

	 GEN3SYS® XT Pro Structural Steel	 T-A® Thin Wall	 T-A® Notch Point®	 T-A® 150° Structural Steel	 GEN2 T-A® High Efficiency
High penetration	<input checked="" type="checkbox"/>				
Material less than 7/16" thick		<input checked="" type="checkbox"/>			
Material over 7/16" thick	<input checked="" type="checkbox"/>		<input checked="" type="checkbox"/>	<input checked="" type="checkbox"/>	<input checked="" type="checkbox"/>
Reduced exit burr			<input checked="" type="checkbox"/>	<input checked="" type="checkbox"/>	
Includes Notch Point® geometry			<input checked="" type="checkbox"/>	<input checked="" type="checkbox"/>	<input checked="" type="checkbox"/>
Available from carbide	<input checked="" type="checkbox"/>				<input checked="" type="checkbox"/>
Stocked in common sizes for the structural steel industry	<input checked="" type="checkbox"/>	<input checked="" type="checkbox"/>	<input checked="" type="checkbox"/>	<input checked="" type="checkbox"/>	<input checked="" type="checkbox"/>



A
DRILLING
B
BORING
C
REAMING
D
BURNISHING
E
THREADING
X
SPECIALS

Case Study Example

CASE STUDY

Project Profile: Structural Steel I-Beam Construction
Tooling Solution: T-A® Structural Steel Drilling System

The Problem:
 Previously, the customer was using a competitor spade drill running at the following parameters:

- 650 RPM
- 0.010 IPR (0.25 mm/rev)
- 6.5 IPM (165.1 mm/min)

The tool drilled a 0.875" (22.23 mm) diameter hole to a 0.4375" (11.11 mm) depth. The drill had a tool life of **only 20 holes**.

The poor tool performance was brought to the attention of the technician, who was familiar with Allied Machine products. The following day, Allied Machine tooling was brought in for testing. The customer needed improvement in the tool life of the inserts.

The Solution:
 Allied Machine recommended the T-A structural steel drilling system.

- **Insert** = 151A-0028-TW (#1 series T-A insert with TiAlN coating and thin wall geometry)
- **Holder** = 25010H-004IS052 (#1 series T-A holder with #4 Morse Taper shank and helical flute)

The tool ran at the following parameters:

- 440 RPM
- 0.010 IPR (0.25 mm/rev)
- 4.4 IPM (111.7 mm/min)

The tool achieved the desired diameter and depth. But most of all, the tool produced **1,500 holes**.

Summary:
 The customer was able to take advantage of Allied Machine’s vast experience in the structural steel drilling niche. Allied’s wide variety of stocked solutions for specific customer problems allows for a remarkable increase in tool life.

The T-A structural steel drilling system defeated the competition, resulting in a **cost per hole savings of 89%** for the customer.



The PROOF is in the NUMBERS

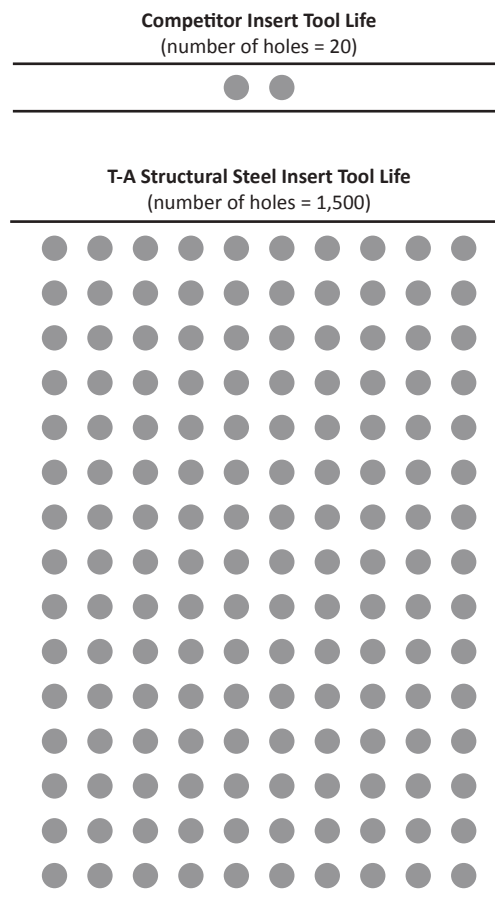

Overall **SAVINGS** of **89%**



A
DRILLING
B
BORING
C
REAMING
D
BURNISHING
E
THREADING
X
SPECIALS



A
DRILLING
B
BORING
C
REAMING
D
BURNISHING
E
THREADING
X
SPECIALS

T-A® and GEN2 T-A® Structural Steel Drilling System

STRUCTURAL STEEL ENHANCEMENTS T-A® & GEN2 T-A®

GEN2 T-A Insert

Available in AM300® and AM200® Coating



High Efficiency (-HE)

- Improves performance.
- Improves tool life.
- Improves chip formation in structural steel materials.

T-A Inserts

Available in AM200® and TiAlN Coatings



Thin Wall (-TW)

- Designed for drilling 7/16" thick or less I-beam or structural materials.
- Increases hole diameter tolerance.
- Improves hole roundness.
- Decreases material deflection.



Notch Point® (-NP)

- Provides excellent self-centering characteristics.
- Reduces bellmouth and tool lead-off.
- Reduces axial thrust requirements.



Structural Steel (-SS)

- Designed for drilling 7/16" thick or thicker I-beam or structural materials.
- Reduces exit burrs.
- Increases stability.
- Lowers drilling forces.
- Includes Notch Point® web geometry.



Holder Anatomy

1. Morse Taper Shank
2. Coolant Inlet
3. Flute (straight or helical)
4. Built-up Body Diameter
5. Coolant Outlets



Straight Flute



Helical Flute

T-A® and GEN2 T-A® Drill Nomenclature

T-A and GEN2 T-A Drill Inserts

4	5	3	H	-	0115	-	HE
1	2	3	4		5		6



1. Insert	2. Material	3. Series	4. Coating	5. Diameter	6. Geometry
1 = T-A 4 = GEN2 T-A	5 = Super cobalt C1 = C1 (K35) carbide	0 = 0 series 1 = 1 series 2 = 2 series 3 = 3 series	P = AM300® H = AM200® A = TiAlN	0017 = Inch 0.515 = Decimal 13 = Metric	TW = Thin Wall NP = Notch Point® SS = Structural Steel HE = High Efficiency

Reference Key

Symbol	Attribute
D_1	Insert diameter
T_1	Insert thickness

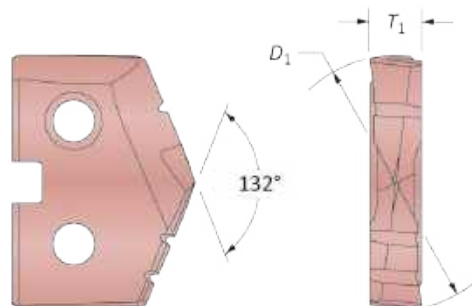

T-A Drill Holders

2	40	20	S	-	004	IS	060
1	2	3	4		5	6	7



1. Holder	2. Length	3. Series	4. Flute
2 = T-A holder	20 = Short 40 = Standard 50 = Extended 60 = Long	00 = 0 series 05 = 0.5 series 10 = 1 series 15 = 1.5 series 20 = 2 series 25 = 2.5 series 30 = 3 series	S = Straight H = Helical
5. Shank Designator	6. Shank Code	7. Minimum Insert Diameter	
003 = 3MT 004 = 4MT	IS = Imperial Morse taper structural steel	In increments of 1/64 of an inch In increments of 0.0156"	

Reference Key

Symbol	Attribute	Symbol	Attribute
D_1	Drill insert range	L_4	Flute length
L_1	Overall length	P_1	Rear pipe tap
L_2	Drill depth	P_2	Side pipe tap
L_3^*	Holder reference length	MT	Morse taper size

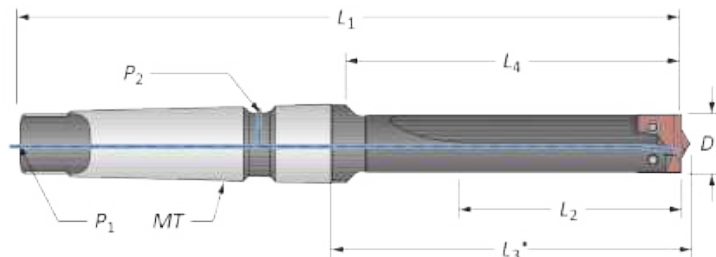

* L_3 is 0.063" (1.60 mm) shorter if using a structural steel holder with Notch Point®, GEN2 T-A®, or 150° structural steel T-A® drill insert geometry.



T-A® Structural Steel Drill Inserts

0 Series | Diameter Range: 0.5512" - 0.6959" (14.00 mm - 17.67 mm)

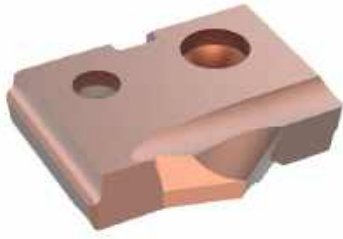

Thin Wall
For material up to 7/16" thick.

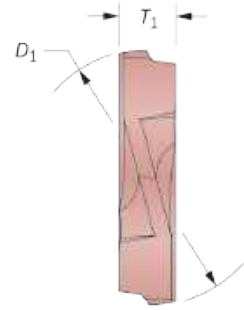
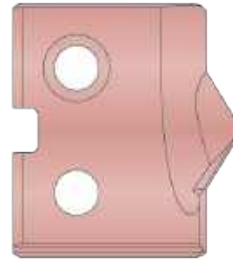

Notch Point®
For material over 7/16" thick.

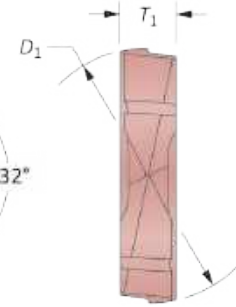

150° Structural Steel
For material over 7/16" thick
and for reduced exit burr.

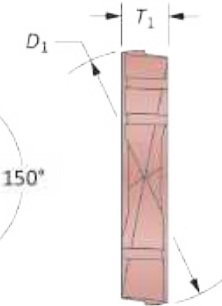
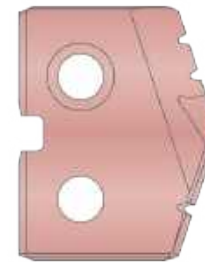

HSS Inserts – Super Cobalt

Series	Insert					Thin Wall		Notch Point®		150° Structural Steel	
	Fractional Equivalent	D ₁ inch	D ₁ mm	T ₁							
					AM200® Part No.	TiAlN Part No.	AM200® Part No.	TiAlN Part No.	AM200® Part No.	TiAlN Part No.	
0	-	0.5512	14.00	1/8	150H-14-TW	150A-14-TW	150H-14-NP	150A-14-NP	150H-14-SS	150A-14-SS	
	9/16	0.5625	14.29	1/8	150H-0018-TW	150A-0018-TW	150H-0018-NP	150A-0018-NP	150H-0018-SS	150A-0018-SS	
	5/8	0.6250	15.88	1/8	150H-0020-TW	150A-0020-TW	150H-0020-NP	150A-0020-NP	150H-0020-SS	150A-0020-SS	
0.5	-	0.6299	16.00	1/8	150H-16-TW	150A-16-TW	150H-16-NP	150A-16-NP	150H-16-SS	150A-16-SS	
	11/16	0.6875	17.46	1/8	150H-0022-TW	150A-0022-TW	150H-0022-NP	150A-0022-NP	150H-0022-SS	150A-0022-SS	

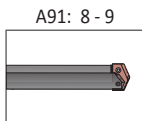
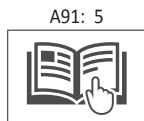
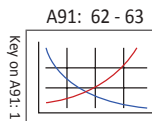



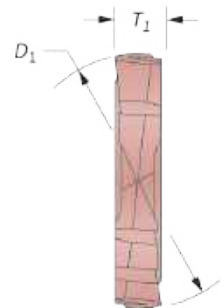
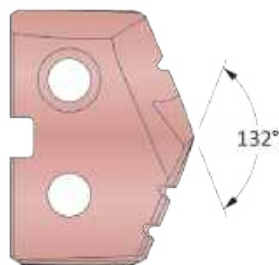

GEN2 T-A® Structural Steel Drill Inserts

0 Series | Diameter Range: 0.5512" - 0.6959" (14.00 mm - 17.67 mm)



HSS Inserts – Super Cobalt | Carbide Inserts – C1 (K35)

Series	Fractional Equivalent	Insert			Part No.	
		D ₁ inch	D ₁ mm	T ₁	 Super Cobalt	 C1 (K35)
0	–	0.5512	14.00	1/8	450H-14-HE	4C10P-14-HE
	9/16	0.5625	14.29	1/8	450H-0018-HE	4C10P-0018-HE
0.5	5/8	0.6250	15.88	1/8	450H-0020-HE	4C10P-0020-HE
	–	0.6299	16.00	1/8	450H-16-HE	4C10P-16-HE
	11/16	0.6875	17.46	1/8	450H-0022-HE	4C10P-0022-HE

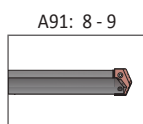
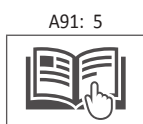
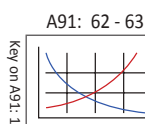

Inserts sold in multiples of 2.

**T-A® Structural Steel Drill Insert Holders**

0 Series | Taper Shank

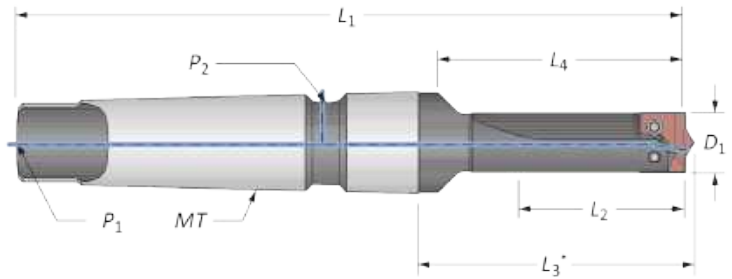
**Straight Flute #3 Morse Taper**

Series	Length	D_1	Body				Shank			Part No.	
			L_2	L_4	L_3^*	L_1	MT	P_1	P_2		
i	0	Short	0.5625	1.201	2.281	2.358	6.156	#3	TTC	TSC	22000S-003IS036
	0.5	Short	0.6250	1.215	2.281	2.358	6.156	#3	TTC	TSC	22005S-003IS040
		Short	0.6875	1.204	2.281	2.358	6.156	#3	TTC	TSC	22005S-003IS044
m	0	Short	14.29	30.51	57.94	59.89	156.36	#3	TTC	TSC	22000S-003IS036
	0.5	Short	15.88	30.86	57.94	59.89	156.36	#3	TTC	TSC	22005S-003IS040
		Short	17.46	30.58	57.94	59.89	156.36	#3	TTC	TSC	22005S-003IS044

* L_3 is 0.063" (1.60 mm) shorter if using a structural steel holder with Notch Point®, GEN2 T-A®, or 150° structural steel T-A® drill insert geometry.

Connection Accessories

Series	Insert Screws	Nylon Locking Screws	Insert Driver	Preset Torque Hand Driver	Replacement Tips	Admissible Tightening Torque*
0	72556-IP8-1	72556N-IP8-1	8IP-8	8IP-8TL	8IP-8B	15.5 in-lbs (175 N-cm)
0.5	72567-IP8-1	72567N-IP8-1	8IP-8	8IP-8TL	8IP-8B	15.5 in-lbs (175 N-cm)

*Tightening torques are calculated with a friction coefficient of $\mu = 0.14$ and develop 90% of ultimate yield strength.

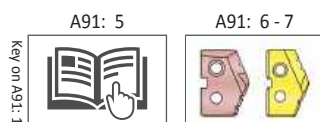

i = Imperial (in)
m = Metric (mm)

Screws sold in multiples of 10.



T-A® Structural Steel Drill Insert Holders

0 Series | Taper Shank

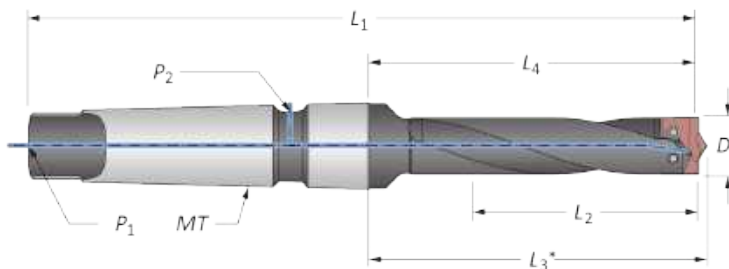

Helical Flute #3 Morse Taper

Series	Length	D ₁	Body				Shank			Part No.	
			L ₂	L ₄	L ₃ *	L ₁	MT	P ₁	P ₂		
i	0	Standard	0.5625	3.001	3.406	3.483	7.281	#3	TTC	TSC	24000H-003IS036
		Extended	0.5625	7.101	9.536	9.613	13.411	#3	TTC	TSC	⚠ 25000H-003IS036
	0.5	Standard	0.6250	3.015	3.406	3.483	7.281	#3	TTC	TSC	24005H-003IS040
		Extended	0.6875	7.129	9.536	9.613	13.411	#3	TTC	TSC	⚠ 25005H-003IS044
m	0	Standard	14.29	76.23	86.51	88.47	184.94	#3	TTC	TSC	24000H-003IS036
		Extended	14.29	180.37	242.21	244.17	340.64	#3	TTC	TSC	⚠ 25000H-003IS036
	0.5	Standard	15.88	76.58	86.51	88.47	184.94	#3	TTC	TSC	24005H-003IS040
		Extended	17.46	181.08	242.21	244.17	340.64	#3	TTC	TSC	⚠ 25005H-003IS044

*L₃ is 0.063" (1.60 mm) shorter if using a structural steel holder with Notch Point®, GEN2 T-A®, or 150° structural steel T-A® drill insert geometry.

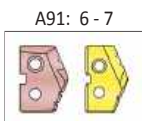
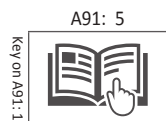

i = Imperial (in)
m = Metric (mm)

Screws sold in multiples of 10.

⚠ WARNING Refer to Speed and Feed charts for recommended adjustments to speeds and feeds. Refer to page A91: 21 for deep hole drilling guidelines in this section of the catalog. Visit www.alliedmachine.com/DeepHoleGuidelines for the most up-to-date information and procedures. Factory technical assistance is available for your specific applications through our Application Engineering Team. ext: 7611 | email: appeng@alliedmachine.com



T-A® Structural Steel Drill Inserts

1 Series | Diameter Range: 0.6900" - 0.9609" (17.53 mm - 24.40 mm)



Thin Wall
For material up to 7/16" thick.

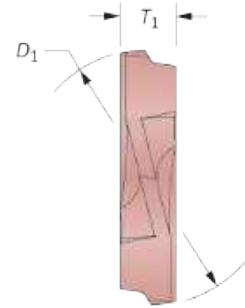
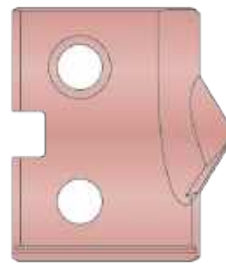

Notch Point®
For material over 7/16" thick.

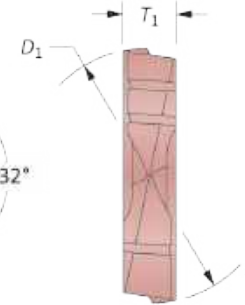

150° Structural Steel
For material over 7/16" thick
and for reduced exit burr.

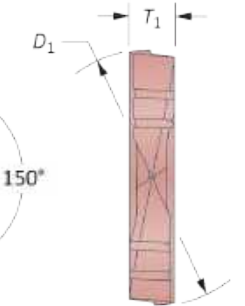
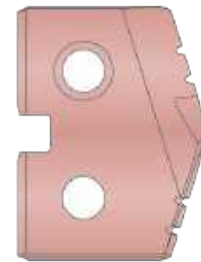

HSS Inserts – Super Cobalt

Series	Insert				Thin Wall		Notch Point®		150° Structural Steel	
	Fractional Equivalent	D ₁ inch	D ₁ mm	T ₁	AM200® Part No.	TiAlN Part No.	AM200® Part No.	TiAlN Part No.	AM200® Part No.	TiAlN Part No.
1	–	0.7087	18.00	5/32	151H-18-TW	151A-18-TW	151H-18-NP	151A-18-NP	151H-18-SS	151A-18-SS
	13/16	0.8125	20.64	5/32	151H-0026-TW	151A-0026-TW	151H-0026-NP	151A-0026-NP	151H-0026-SS	151A-0026-SS
	–	0.8268	21.00	5/32	151H-21-TW	151A-21-TW	151H-21-NP	151A-21-NP	151H-21-SS	151A-21-SS
	–	0.8661	22.00	5/32	151H-22-TW	151A-22-TW	151H-22-NP	151A-22-NP	151H-22-SS	151A-22-SS
1.5	7/8	0.8750	22.23	5/32	151H-0028-TW	151A-0028-TW	151H-0028-NP	151A-0028-NP	151H-0028-SS	151A-0028-SS
	15/16	0.9375	23.81	5/32	151H-0030-TW	151A-0030-TW	151H-0030-NP	151A-0030-NP	151H-0030-SS	151A-0030-SS
	–	0.9449	24.00	5/32	151H-24-TW	151A-24-TW	151H-24-NP	151A-24-NP	151H-24-SS	151A-24-SS

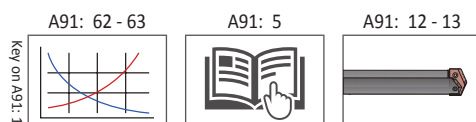



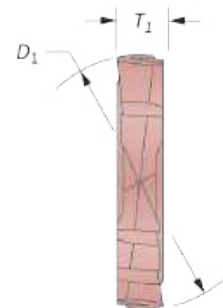
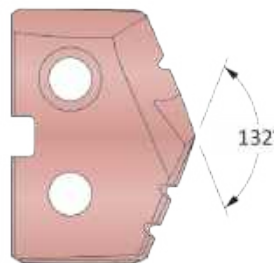

GEN2 T-A® Structural Steel Drill Inserts

1 Series | Diameter Range: 0.6900" - 0.9609" (17.53 mm - 24.40 mm)



HSS Inserts – Super Cobalt | Carbide Inserts – C1 (K35)

Series	Fractional Equivalent	Insert			Part No.	
		D ₁ inch	D ₁ mm	T ₁	 Super Cobalt	 C1 (K35)
1	–	0.7087	18.00	5/32	451H-18-HE	4C11P-18-HE
	13/16	0.8125	20.64	5/32	451H-0026-HE	4C11P-0026-HE
	–	0.8268	21.00	5/32	451H-21-HE	4C11P-21-HE
	–	0.8661	22.00	5/32	451H-22-HE	4C11P-22-HE
1.5	7/8	0.8750	22.23	5/32	451H-0028-HE	4C11P-0028-HE
	15/16	0.9375	23.81	5/32	451H-0030-HE	4C11P-0030-HE
	–	0.9449	24.00	5/32	451H-24-HE	4C11P-24-HE

Key on A91-1

A91: 62 - 63

A91: 5

A91: 12 - 13

Inserts sold in multiples of 2.

**T-A® Structural Steel Drill Insert Holders**

1 Series | Taper Shank

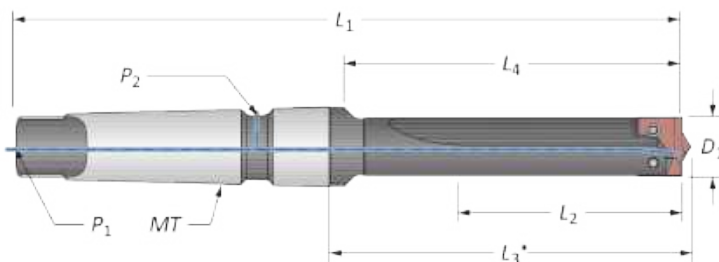
**Straight Flute #3 Morse Taper**

Series	Length	D_1	Body				Shank			Part No.	
			L_2	L_4	L_3^*	L_1	MT	P_1	P_2		
i	1	Short	0.7031	2.558	3.954	4.078	7.829	#3	TTC	TSC	22010S-003IS045
		Short	0.8125	2.558	3.954	4.078	7.829	#3	TTC	TSC	22010S-003IS052
	1.5	Short	0.8750	2.572	3.954	4.078	7.829	#3	TTC	TSC	22015S-003IS056
		Short	0.9375	2.586	3.954	4.078	7.829	#3	TTC	TSC	22015S-003IS060
m	1	Short	17.86	64.97	100.43	103.58	198.86	#3	TTC	TSC	22010S-003IS045
		Short	20.64	64.97	100.43	103.58	198.86	#3	TTC	TSC	22010S-003IS052
	1.5	Short	22.23	65.33	100.43	103.58	198.86	#3	TTC	TSC	22015S-003IS056
		Short	23.81	65.68	100.43	103.58	198.86	#3	TTC	TSC	22015S-003IS060

* L_3 is 0.063" (1.60 mm) shorter if using a structural steel holder with Notch Point®, GEN2 T-A®, or 150° structural steel T-A® drill insert geometry.**Straight Flute #4 Morse Taper**

Series	Length	D_1	Body				Shank			Part No.	
			L_2	L_4	L_3^*	L_1	MT	P_1	P_2		
i	1	Short	0.7031	2.558	3.954	4.078	8.829	#4	TTC	TSC	22010S-004IS045
		Short	0.8125	2.558	3.954	4.078	8.829	#4	TTC	TSC	22010S-004IS052
	1.5	Short	0.8750	2.572	3.954	4.078	8.829	#4	TTC	TSC	22015S-004IS056
		Short	0.9375	2.586	3.954	4.078	8.829	#4	TTC	TSC	22015S-004IS060
m	1	Short	17.86	64.97	100.43	103.58	224.26	#4	TTC	TSC	22010S-004IS045
		Short	20.64	64.97	100.43	103.58	224.26	#4	TTC	TSC	22010S-004IS052
	1.5	Short	22.23	65.33	100.43	103.58	224.26	#4	TTC	TSC	22015S-004IS056
		Short	23.81	65.68	100.43	103.58	224.26	#4	TTC	TSC	22015S-004IS060

* L_3 is 0.063" (1.60 mm) shorter if using a structural steel holder with Notch Point®, GEN2 T-A®, or 150° structural steel T-A® drill insert geometry.**Connection Accessories**

Series	Insert Screws	Nylon Locking Screws	Insert Driver	Preset Torque Hand Driver	Replacement Tips	Admissible Tightening Torque*
1	7375-IP9-1	7375N-IP9-1	8IP-9	8IP-9TL	8IP-9B	27.0 in-lbs (305 N-cm)
1.5	739-IP9-1	739N-IP9-1	8IP-9	8IP-9TL	8IP-9B	27.0 in-lbs (305 N-cm)

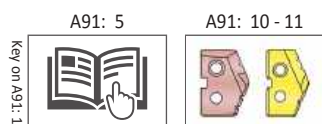
*Tightening torques are calculated with a friction coefficient of $\mu = 0.14$ and develop 90% of ultimate yield strength.i = Imperial (in)
m = Metric (mm)

Screws sold in multiples of 10.



T-A® Structural Steel Drill Insert Holders

1 Series | Taper Shank

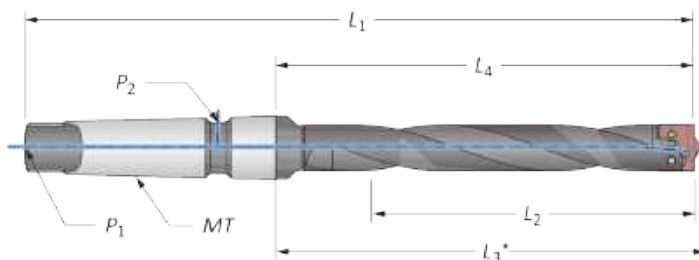

Helical Flute #3 Morse Taper

Series	Length	D ₁	Body				Shank			Part No.	
			L ₂	L ₄	L ₃ *	L ₁	MT	P ₁	P ₂		
i	1	Standard	0.7031	5.423	5.954	6.078	9.829	#3	TTC	TSC	24010H-003IS045
		Standard	0.8125	5.423	5.954	6.078	9.829	#3	TTC	TSC	24010H-003IS052
		Extended	0.7031	7.108	9.423	9.547	13.298	#3	TTC	TSC	⚠ 25010H-003IS045
	1.5	Extended	0.8125	7.108	9.423	9.547	13.298	#3	TTC	TSC	⚠ 25010H-003IS052
		Standard	0.8750	5.519	5.954	6.078	9.829	#3	TTC	TSC	24015H-003IS056
		Standard	0.9375	5.529	5.954	6.078	9.829	#3	TTC	TSC	24015H-003IS060
m	1	Extended	0.9375	7.136	9.423	9.547	13.298	#3	TTC	TSC	⚠ 25015H-003IS060
		Standard	17.86	137.74	151.23	154.38	249.66	#3	TTC	TSC	24010H-003IS045
		Standard	20.64	137.74	151.23	154.38	249.66	#3	TTC	TSC	24010H-003IS052
	1.5	Extended	17.86	180.54	239.34	242.49	337.77	#3	TTC	TSC	⚠ 25010H-003IS045
		Extended	20.64	180.54	239.34	242.49	337.77	#3	TTC	TSC	⚠ 25010H-003IS052
		Standard	22.23	140.18	151.23	154.38	249.66	#3	TTC	TSC	24015H-003IS056
1.5	Standard	23.81	140.44	151.23	154.38	249.66	#3	TTC	TSC	24015H-003IS060	
	Extended	23.81	181.25	239.34	242.49	337.77	#3	TTC	TSC	⚠ 25015H-003IS060	

*L₃ is 0.063" (1.60 mm) shorter if using a structural steel holder with Notch Point®, GEN2 T-A®, or 150° structural steel T-A® drill insert geometry.

Helical Flute #4 Morse Taper

Series	Length	D ₁	Body				Shank			Part No.	
			L ₂	L ₄	L ₃ *	L ₁	MT	P ₁	P ₂		
i	1	Standard	0.7031	5.298	5.954	6.078	10.829	#4	TTC	TSC	24010H-004IS045
		Standard	0.8125	5.298	5.954	6.078	10.829	#4	TTC	TSC	24010H-004IS052
		Extended	0.8125	6.688	9.360	9.484	14.235	#4	TTC	TSC	⚠ 25010H-004IS052
	1.5	Long	0.8125	6.563	15.857	15.981	20.732	#4	TTC	TSC	⚠ 26010H-004IS052
		Standard	0.8750	5.371	5.954	6.078	10.829	#4	TTC	TSC	24015H-004IS056
		Standard	0.9375	5.411	5.954	6.078	10.829	#4	TTC	TSC	24015H-004IS060
m	1	Extended	0.9375	6.816	9.360	9.484	14.235	#4	TTC	TSC	⚠ 25015H-004IS060
		Long	0.9375	6.816	15.889	16.013	20.764	#4	TTC	TSC	⚠ 26015H-004IS060
		Standard	17.86	134.57	151.23	154.38	275.06	#4	TTC	TSC	24010H-004IS045
	1.5	Standard	20.64	134.57	151.23	154.38	275.06	#4	TTC	TSC	24010H-004IS052
		Extended	20.64	169.88	237.74	240.89	361.57	#4	TTC	TSC	⚠ 25010H-004IS052
		Long	20.64	166.7	402.77	405.92	526.59	#4	TTC	TSC	⚠ 26010H-004IS052
1.5	Standard	22.23	136.42	151.23	154.38	275.06	#4	TTC	TSC	24015H-004IS056	
	Standard	23.81	137.44	151.23	154.38	275.06	#4	TTC	TSC	24015H-004IS060	
	Extended	23.81	173.13	237.74	240.89	361.57	#4	TTC	TSC	⚠ 25015H-004IS060	
1.5	Long	23.81	173.13	403.58	406.73	527.41	#4	TTC	TSC	⚠ 26015H-004IS060	

*L₃ is 0.063" (1.60 mm) shorter if using a structural steel holder with Notch Point®, GEN2 T-A®, or 150° structural steel T-A® drill insert geometry.

A91: 5

A91: 10 - 11

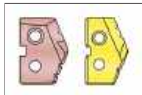

i = Imperial (in)

m = Metric (mm)

Screws sold in multiples of 10.

⚠ WARNING Refer to Speed and Feed charts for recommended adjustments to speeds and feeds. Refer to page A91: 21 for deep hole drilling guidelines in this section of the catalog. Visit www.alliedmachine.com/DeepHoleGuidelines for the most up-to-date information and procedures. Factory technical assistance is available for your specific applications through our Application Engineering Team. ext: 7611 | email: appeng@alliedmachine.com

2

DRILLING | Structural Steel Solutions | T-A® and GEN2 T-A® Replaceable Insert Drills

T-A® Structural Steel Drill Inserts

2 Series | Diameter Range: 0.9610" - 1.3809" (24.41 mm - 35.06 mm)

Thin Wall
For material up to 7/16" thick.

Notch Point®
For material over 7/16" thick.

150° Structural Steel
For material over 7/16" thick
and for reduced exit burr.

HSS Inserts – Super Cobalt

Series	Insert				Thin Wall		Notch Point®		150° Structural Steel	
	Fractional Equivalent	D ₁ inch	D ₁ mm	T ₁	AM200® Part No.	TiAlN Part No.	AM200® Part No.	TiAlN Part No.	AM200® Part No.	TiAlN Part No.
2	1	1.0000	25.40	3/16	152H-0100-TW	152A-0100-TW	152H-0100-NP	152A-0100-NP	152H-0100-SS	152A-0100-SS
	–	1.0236	26.00	3/16	152H-26-TW	152A-26-TW	152H-26-NP	152A-26-NP	152H-26-SS	152A-26-SS
	1-1/16	1.0625	26.99	3/16	152H-0102-TW	152A-0102-TW	152H-0102-NP	152A-0102-NP	152H-0102-SS	152A-0102-SS
	–	1.0630	27.00	3/16	152H-27-TW	152A-27-TW	152H-27-NP	152A-27-NP	152H-27-SS	152A-27-SS
	1-1/8	1.1250	28.58	3/16	152H-0104-TW	152A-0104-TW	152H-0104-NP	152A-0104-NP	152H-0104-SS	152A-0104-SS
2.5	1-3/16	1.1875	30.16	3/16	152H-0106-TW	152A-0106-TW	152H-0106-NP	152A-0106-NP	152H-0106-SS	152A-0106-SS
	–	1.2205	31.00	3/16	152H-31-TW	152A-31-TW	152H-31-NP	152A-31-NP	152H-31-SS	152A-31-SS
	1-1/4	1.2500	31.75	3/16	152H-0108-TW	152A-0108-TW	152H-0108-NP	152A-0108-NP	152H-0108-SS	152A-0108-SS
	–	1.2992	33.00	3/16	152H-33-TW	152A-33-TW	152H-33-NP	152A-33-NP	152H-33-SS	152A-33-SS
	1-5/16	1.3125	33.34	3/16	152H-0110-TW	152A-0110-TW	152H-0110-NP	152A-0110-NP	152H-0110-SS	152A-0110-SS
	1-3/8	1.3750	34.93	3/16	152H-0112-TW	152A-0112-TW	152H-0112-NP	152A-0112-NP	152H-0112-SS	152A-0112-SS

A91: 62 - 63

A91: 5

A91: 16 - 17

Inserts sold in multiples of 2.

A91: 14

www.alliedmachine.com | 1.330.343.4283

A DRILLING

B BORING

C REAMING

D BURISHING

E THREADING

X SPECIALS



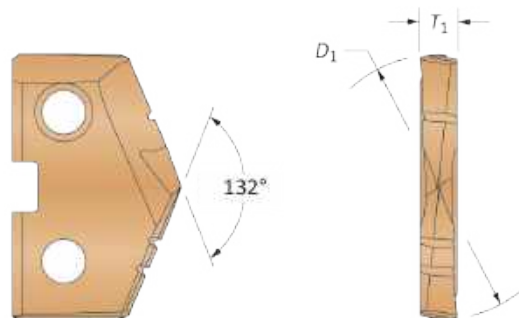

GEN2 T-A® Structural Steel Drill Inserts

2 Series | Diameter Range: 0.9610" - 1.3809" (24.41 mm - 35.06 mm)



HSS Inserts – Super Cobalt | Carbide Inserts – C1 (K35)

Series	Fractional Equivalent	Insert			Part No.	
		D ₁ inch	D ₁ mm	T ₁	 Super Cobalt	 C1 (K35)
2	1	1.0000	25.40	3/16	452H-0100-HE	4C12P-0100-HE
	–	1.0236	26.00	3/16	452H-26-HE	4C12P-26-HE
	1-1/16	1.0625	26.99	3/16	452H-0102-HE	4C12P-0102-HE
	–	1.0630	27.00	3/16	452H-27-HE	4C12P-27-HE
	1-1/8	1.1250	28.58	3/16	452H-0104-HE	4C12P-0104-HE
2.5	1-3/16	1.1875	30.16	3/16	452H-0106-HE	4C12P-0106-HE
	–	1.2205	31.00	3/16	452H-31-HE	4C12P-31-HE
	1-1/4	1.2500	31.75	3/16	452H-0108-HE	4C12P-0108-HE
	–	1.2992	33.00	3/16	452H-33-HE	4C12P-33-HE
	1-5/16	1.3125	33.34	3/16	452H-0110-HE	4C12P-0110-HE
	1-3/8	1.3750	34.93	3/16	452H-0112-HE	4C12P-0112-HE

A

DRILLING

B

BORING

C

REAMING

D

BURNISHING

E

THREADING

X

SPECIALS

Key on A91-1

A91: 62 - 63

A91: 5

A91: 16 - 17

Inserts sold in multiples of 2.



T-A® Structural Steel Drill Insert Holders

2 Series | Taper Shank

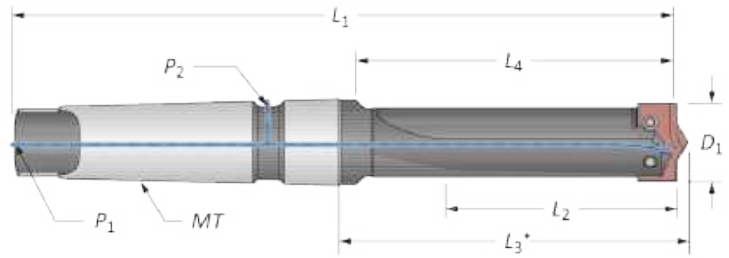

Straight Flute #4 Morse Taper

Series	Length	D_1	Body				Shank			Part No.	
			L_2	L_4	L_3^*	L_1	MT	P_1	P_2		
i	2	Short	1.0000	3.211	4.574	4.725	9.449	#4	TTC	TSC	22020S-004IS100
	2.5	Short	1.1875	3.253	4.574	4.725	9.449	#4	TTC	TSC	22025S-004IS112
m	2	Short	25.40	81.56	116.18	120.02	240.00	#4	TTC	TSC	22020S-004IS100
	2.5	Short	30.16	82.63	116.18	120.02	240.00	#4	TTC	TSC	22025S-004IS112

* L_3 is 0.063" (1.60 mm) shorter if using a structural steel holder with Notch Point®, GEN2 T-A®, or 150° structural steel T-A® drill insert geometry.

Connection Accessories

Series	Insert Screws	Nylon Locking Screws	Insert Driver	Preset Torque Hand Driver	Replacement Tips	Admissible Tightening Torque*
2	7495-IP15-1	7495N-IP15-1	8IP-15	8IP-15TL	8IP-15B	61.0 in-lbs (690 N-cm)
2.5	7495-IP15-1	7495N-IP15-1	8IP-15	8IP-15TL	8IP-15B	61.0 in-lbs (690 N-cm)

*Tightening torques are calculated with a friction coefficient of $\mu = 0.14$ and develop 90% of ultimate yield strength.

A91: 5

A91: 14 - 15

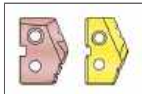

i = Imperial (in)
m = Metric (mm)

Screws sold in multiples of 10.



T-A® Structural Steel Drill Insert Holders

2 Series | Taper Shank

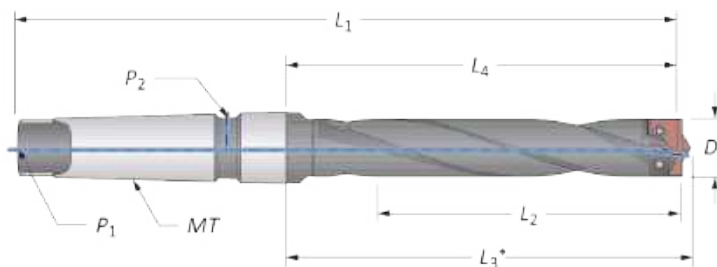

Helical Flute #3 Morse Taper

Series	Length	D ₁	Body				Shank			Part No.
			L ₂	L ₄	L ₃ *	L ₁	MT	P ₁	P ₂	
i 2	Extended	1.0000	7.142	9.412	9.563	13.287	#3	TTC	TSC	25020H-003IS100
m 2	Extended	25.4	181.41	239.06	242.9	337.49	#3	TTC	TSC	25020H-003IS100

*L₃ is 0.063" (1.60 mm) shorter if using a structural steel holder with Notch Point®, GEN2 T-A®, or 150° structural steel T-A® drill insert geometry.

Helical Flute #4 Morse Taper

Series	Length	D ₁	Body				Shank			Part No.
			L ₂	L ₄	L ₃ *	L ₁	MT	P ₁	P ₂	
i 2	Standard	1.0000	5.855	6.574	6.725	11.449	#4	TTC	TSC	24020H-004IS100
	Extended	1.0000	6.772	9.355	9.506	14.230	#4	TTC	TSC	25020H-004IS100
	Long	1.0000	6.772	16.071	16.222	20.946	#4	TTC	TSC	26020H-004IS100
i 2.5	Standard	1.1875	5.855	6.574	6.725	11.449	#4	TTC	TSC	24025H-004IS112
m 2	Standard	25.40	148.72	166.98	170.82	290.80	#4	TTC	TSC	24020H-004IS100
	Extended	25.40	172.01	237.62	241.45	361.44	#4	TTC	TSC	25020H-004IS100
	Long	25.40	172.01	408.20	412.04	532.03	#4	TTC	TSC	26020H-004IS100
m 2.5	Standard	30.16	148.72	166.98	170.82	290.80	#4	TTC	TSC	24025H-004IS112

*L₃ is 0.063" (1.60 mm) shorter if using a structural steel holder with Notch Point®, GEN2 T-A®, or 150° structural steel T-A® drill insert geometry.

A91: 5

A91: 14 - 15

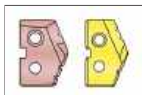

i = Imperial (in)

m = Metric (mm)

Screws sold in multiples of 10.

WARNING Refer to Speed and Feed charts for recommended adjustments to speeds and feeds. Refer to page A91: 21 for deep hole drilling guidelines in this section of the catalog. Visit www.alliedmachine.com/DeepHoleGuidelines for the most up-to-date information and procedures. Factory technical assistance is available for your specific applications through our Application Engineering Team. ext: 7611 | email: appeng@alliedmachine.com



T-A® Structural Steel Drill Inserts

3 Series | Diameter Range: 1.3530" - 1.8829" (34.37 mm - 47.82 mm)



Thin Wall
For material up to 7/16" thick.

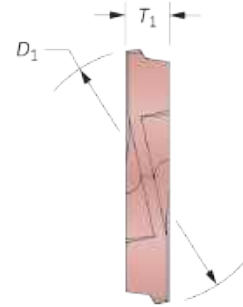



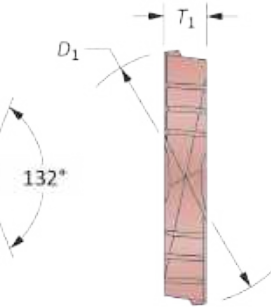

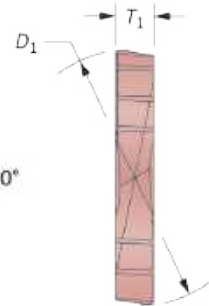
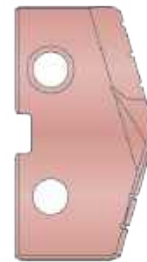

Notch Point®
For material over 7/16" thick.



150° Structural Steel
For material over 7/16" thick
and for reduced exit burr.



HSS Inserts – Super Cobalt

Insert				Thin Wall		Notch Point®		150° Structural Steel	
Fractional Equivalent	D ₁ inch	D ₁ mm	T ₁						
				AM200® Part No.	TiAlN Part No.	AM200® Part No.	TiAlN Part No.	AM200® Part No.	TiAlN Part No.
1-7/16	1.4375	36.51	1/4	153H-0114-TW	153A-0114-TW	153H-0114-NP	153A-0114-NP	153H-0114-SS	153A-0114-SS
1-1/2	1.5000	38.10	1/4	153H-0116-TW	153A-0116-TW	153H-0116-NP	153A-0116-NP	153H-0116-SS	153A-0116-SS
-	1.5354	39.00	1/4	153H-39-TW	153A-39-TW	153H-39-NP	153A-39-NP	153H-39-SS	153A-39-SS
1-9/16	1.5625	39.69	1/4	153H-0118-TW	153A-0118-TW	153H-0118-NP	153A-0118-NP	153H-0118-SS	153A-0118-SS

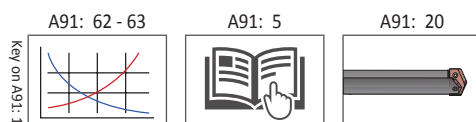

Inserts sold in multiples of 1.



GEN2 T-A® Structural Steel Drill Inserts

3 Series | Diameter Range: 1.3530" - 1.8829" (34.37 mm - 47.82 mm)

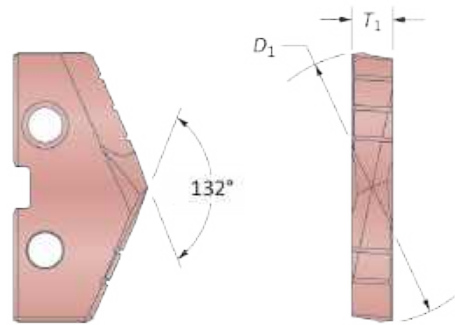

HSS Inserts – Super Cobalt

Fractional Equivalent	Insert			Part No.
	D_1 inch	D_1 mm	T_1	 Super Cobalt
1-7/16	1.4375	36.51	1/4	453H-0114-HE
1-1/2	1.5000	38.10	1/4	453H-0116-HE
-	1.5354	39.00	1/4	453H-39-HE
1-9/16	1.5625	39.69	1/4	453H-0118-HE

Key on A91-1

A91: 62 - 63

A91: 5

A91: 20

Inserts sold in multiples of 1.



T-A® Structural Steel Drill Insert Holders

3 Series | Taper Shank

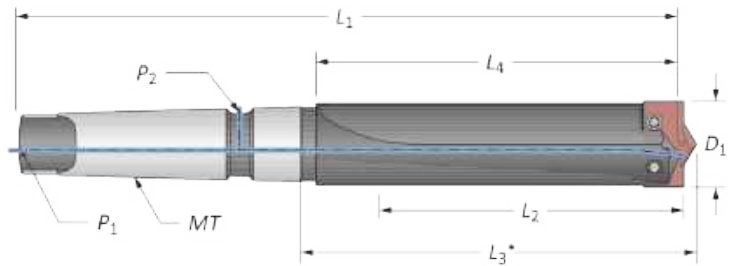

Straight Flute #4 Morse Taper

Length	D_1	Body				Shank			Part No.
		L_2	L_4	L_3^*	L_1	MT	P_1	P_2	
① Short	1.4063	4.441	6.037	6.250	10.912	#4	TTC	TSC	22030S-004IS126

* L_3 is 0.063" (1.60 mm) shorter if using a structural steel holder with Notch Point®, GEN2 T-A®, or 150° structural steel T-A® drill insert geometry.

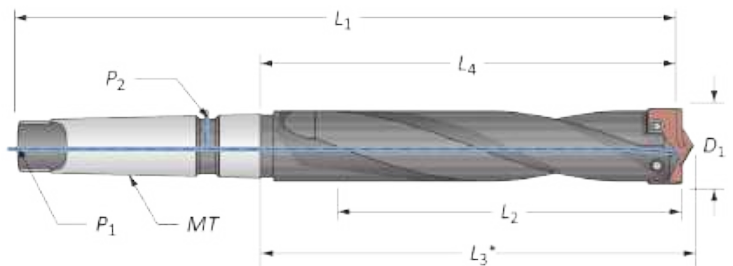

Helical Flute #4 Morse Taper

Length	D_1	Body				Shank			Part No.
		L_2	L_4	L_3^*	L_1	MT	P_1	P_2	
① Standard	1.4063	7.118	7.787	8.000	12.662	#4	TTC	TSC	24030H-004IS126

* L_3 is 0.063" (1.60 mm) shorter if using a structural steel holder with Notch Point®, GEN2 T-A®, or 150° structural steel T-A® drill insert geometry.

Connection Accessories

Insert Screws	Nylon Locking Screws	Insert Driver	Preset Torque Hand Driver	Replacement Tips	Admissible Tightening Torque*
7514-IP20-1	7514N-IP20-1	8IP-20	-	-	121.3 in-lbs (1370 N-cm)

*Tightening torques are calculated with a friction coefficient of $\mu = 0.14$ and develop 90% of ultimate yield strength.

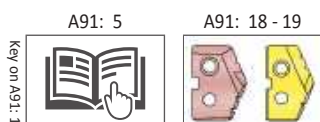

A91: 20

www.alliedmachine.com | 1.330.343.4283

① = Imperial (in)
 Ⓜ = Metric (mm)

Screws sold in multiples of 10.

Deep Hole Drilling Guidelines

For Use with Drills Greater than 9xD (Extended, Long, XL, 3XL, and Special Length)

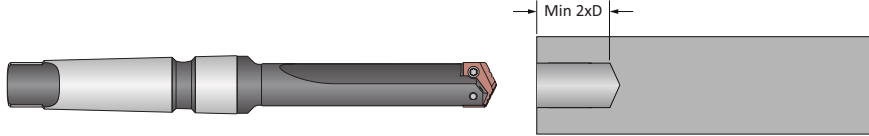
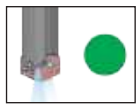
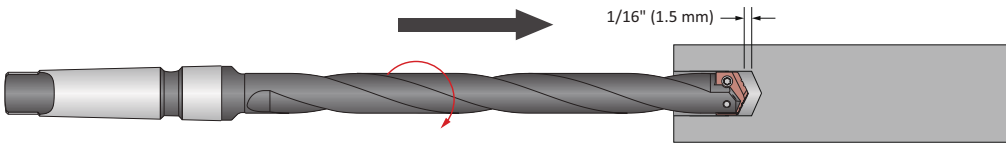
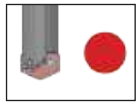
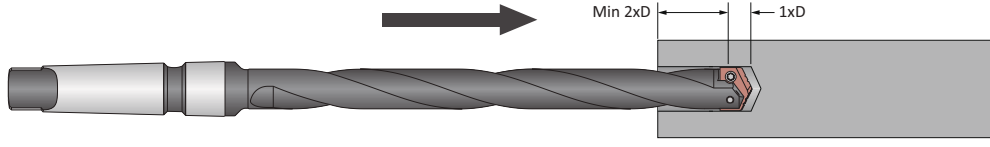
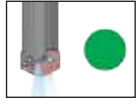
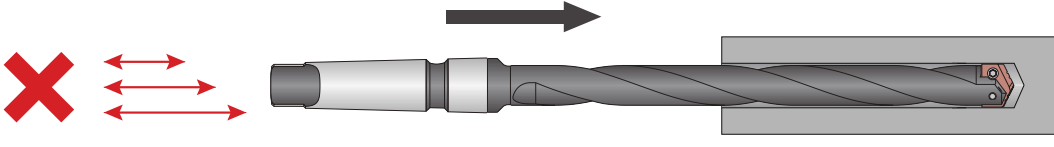
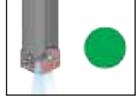
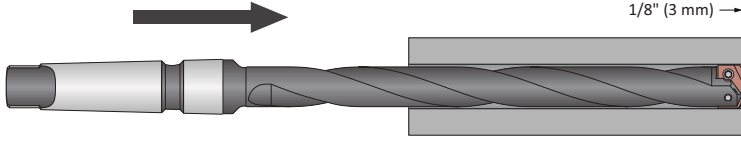
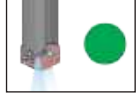
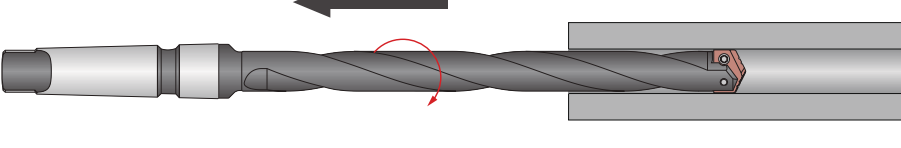
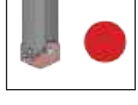
<p>1. Pilot Hole 100 % RPM 100% IPR (mm/rev)</p>	<p>Establish the pilot hole using the same diameter short drill to a depth of 2xD minimum. Utilize a pilot drill with the same or larger included point angle.</p> 	<p>Coolant ON</p> 
<p>⚠ 2. Feed-in 50 RPM max 12 IPM (300 mm/min)</p>	<p>Feed the longer drill within 1/16" (1.5 mm) short of the established pilot hole bottom at a maximum of 50 RPM and 12 IPM (300 mm/min) feed rate.</p> 	<p>Coolant OFF</p> 
<p>3. Deep Hole Transition Drilling 50 % RPM 75% IPR (mm/rev)</p>	<p>Drill additional 1xD past the bottom of the pilot hole at 50% reduction of recommended speed and 25% reduction of recommended feed. Minimum of 1 second dwell is required to meet full speed before feeding.</p> 	<p>Coolant ON</p> 
<p>4. Deep Hole Drilling - Blind 100% RPM 100% IPR (mm/rev)</p>	<p>Drill to full depth at recommended speed and feed for longer drill according to Allied speed and feed charts. No peck cycle recommended.</p> 	<p>Coolant ON</p> 
<p>5. Deep Hole Drilling - at Breakout 50% RPM 75% IPR (mm/rev)</p>	<p>For through holes only: Reduce speed by 50% and feed by 25% prior to breakout. Do not breakout more than 1/8" (3 mm) past the full diameter of the drill.</p> 	<p>Coolant ON</p> 
<p>⚠ 6. Drill Retract 50 RPM max</p>	<p>Reduce speed to a maximum of 50 RPM before retracting from the hole.</p> 	<p>Coolant OFF</p> 

⚠ WARNING Tool failure can cause serious injury. To prevent:

- When using holders without support bushing, use a short T-A® holder to establish an initial hole that is a minimum of 2 diameters deep.
- Do not rotate tool holders more than 50 RPM unless it is engaged with the workpiece or fixture.

Visit www.alliedmachine.com/DeepHoleGuidelines for the most up-to-date information and procedures. Factory technical assistance is available for your specific applications through our Application Engineering Team. ext: 7611 | email: appeng@alliedmachine.com

A
DRILLING
B
BORING
C
REAMING
D
BURNISHING
E
THREADING
X
SPECIALS

GEN3SYS® XT Pro Structural Steel Drilling System

A
DRILLING
B
BORING
C
REAMING
D
BURNISHING
E
THREADING
X
SPECIALS

GEN3SYS® XT Pro **ST**
STRUCTURAL STEEL ENHANCEMENTS

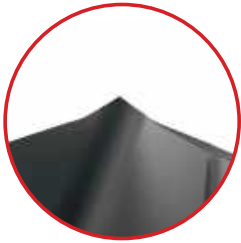
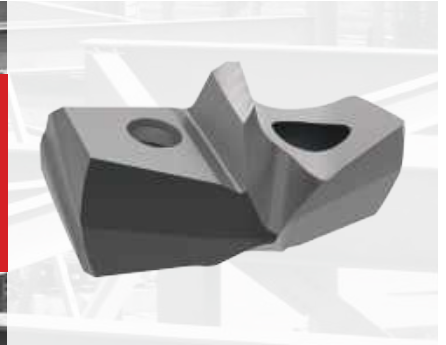

New Point Design

Increases stability without hindering penetration

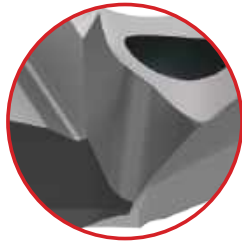

Redesigned Insert

Provides consistent performance and adds durability

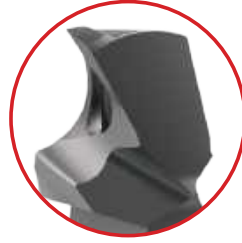

Improved Geometry

Extends tool life and increases insert strength without increasing horsepower consumption



AM420

AM420 Coating

Increases heat threshold and extends tool life

Get the Consistency You Need

The challenge of drilling structural steel materials is about to get easier. Developed through a rigorous and thorough testing process, the modified and improved XTST insert is a product of innovation.

Achieve the **consistent performance** you need while matching or even exceeding your current parameters.

Tough Drilling is Tough No More

Structural steel applications can prove to be difficult to machine, so you need a drill that's been put through the fire to ensure it can conquer those challenging applications.

Rigorous testing and countless hours of design and programming make the XT Pro structural steel insert the optimal drill for structural steel applications.

- Diameter range: 0.4724" - 1.3780" (12.00 mm - 35.00 mm).
- Holders available in 1.5xD, 3xD, 5xD, and 7xD lengths.
- Flanged shank with flat.



1.5xD

3xD

5xD

7xD



NOTICE: Structural steel GEN3SYS holders are specifically designed to be used only with GEN3SYS XT Pro structural steel geometry inserts. Using other GEN3SYS XT or XT Pro insert geometries in these holders could lead to chip packing and tool failure.
Contact Application Engineering for questions regarding proper use of tools. ext: 7611 | email: appeng@alliedmachine.com

GEN3SYS® XT Pro Drill Nomenclature

GEN3SYS XT Pro Drill Inserts

XT	ST	20	–	20.00
1	2	3		4



1. XT Pro Drill Insert	2. Geometry	3. Series	4. Diameter (mm)															
XT = XT Pro insert	ST = Structural Steel	<table border="0"> <tr> <td>12 = 12 series</td> <td>17 = 17 series</td> <td>26 = 26 series</td> </tr> <tr> <td>13 = 13 series</td> <td>18 = 18 series</td> <td>29 = 29 series</td> </tr> <tr> <td>14 = 14 series</td> <td>20 = 20 series</td> <td>32 = 32 series</td> </tr> <tr> <td>15 = 15 series</td> <td>22 = 22 series</td> <td></td> </tr> <tr> <td>16 = 16 series</td> <td>24 = 24 series</td> <td></td> </tr> </table>	12 = 12 series	17 = 17 series	26 = 26 series	13 = 13 series	18 = 18 series	29 = 29 series	14 = 14 series	20 = 20 series	32 = 32 series	15 = 15 series	22 = 22 series		16 = 16 series	24 = 24 series		For complete list of diameter ranges by series, see contents page.
12 = 12 series	17 = 17 series	26 = 26 series																
13 = 13 series	18 = 18 series	29 = 29 series																
14 = 14 series	20 = 20 series	32 = 32 series																
15 = 15 series	22 = 22 series																	
16 = 16 series	24 = 24 series																	

Reference Key

Symbol	Attribute
D_1	Insert diameter

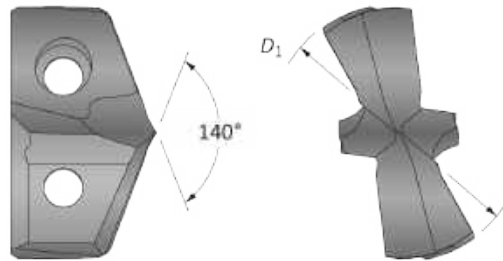

Sizes not shown are available upon request.
When ordering, please follow the example below:

Imperial:	0.7913", 20 series = use Part No. XTST20-20.10
Metric:	20.10 mm, 20 series = use Part No. XTST20-20.10

GEN3SYS XT Structural Steel Drill Holders

ST	03	12	0	–	20	FM
1	2	3	4		5	6



1. Holder	2. Length	3. Series	4. Body Diameter																					
ST = Structural steel holder	<table border="0"> <tr><td>01 = 1.5xD</td></tr> <tr><td>03 = 3xD</td></tr> <tr><td>05 = 5xD</td></tr> <tr><td>07 = 7xD</td></tr> </table>	01 = 1.5xD	03 = 3xD	05 = 5xD	07 = 7xD	<table border="0"> <tr> <td>12 = 12 series</td> <td>17 = 17 series</td> <td>26 = 26 series</td> </tr> <tr> <td>13 = 13 series</td> <td>18 = 18 series</td> <td>29 = 29 series</td> </tr> <tr> <td>14 = 14 series</td> <td>20 = 20 series</td> <td>32 = 32 series</td> </tr> <tr> <td>15 = 15 series</td> <td>22 = 22 series</td> <td></td> </tr> <tr> <td>16 = 16 series</td> <td>24 = 24 series</td> <td></td> </tr> </table>	12 = 12 series	17 = 17 series	26 = 26 series	13 = 13 series	18 = 18 series	29 = 29 series	14 = 14 series	20 = 20 series	32 = 32 series	15 = 15 series	22 = 22 series		16 = 16 series	24 = 24 series		<table border="0"> <tr><td>0 = Standard</td></tr> <tr><td>5 = Oversized</td></tr> </table>	0 = Standard	5 = Oversized
01 = 1.5xD																								
03 = 3xD																								
05 = 5xD																								
07 = 7xD																								
12 = 12 series	17 = 17 series	26 = 26 series																						
13 = 13 series	18 = 18 series	29 = 29 series																						
14 = 14 series	20 = 20 series	32 = 32 series																						
15 = 15 series	22 = 22 series																							
16 = 16 series	24 = 24 series																							
0 = Standard																								
5 = Oversized																								

5. Shank Diameter	
Imperial (in)	Metric (mm)
063 = 5/8" 125 = 1-1/4"	16 = 16 mm 32 = 32 mm
075 = 3/4" 150 = 1-1/2"	20 = 20 mm 40 = 40 mm
100 = 1"	25 = 25 mm

6. Shank Style
F = Flanged with flat
FM = Flanged metric with flat
C = Cylindrical (no flat)
CM = Cylindrical metric (no flat)

Reference Key

Symbol	Attribute
D_2	Shank diameter
L_1	Overall length
L_2	Drill depth
L_3	Holder reference length
L_4	Holder body length
L_7	Shank length
P_1	Rear pipe tap

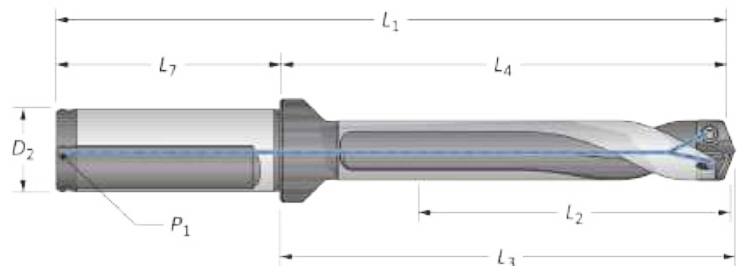

**GEN3SYS® XT Pro Structural Steel Drilling System**

12 Series | Diameter Range: 0.4724" - 0.5117" (12.00 mm - 12.99 mm)

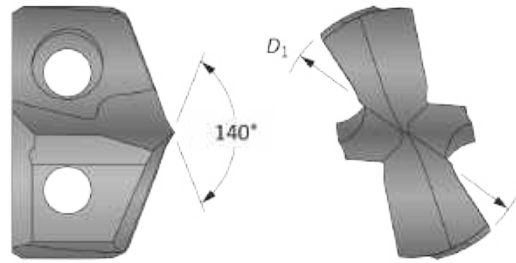

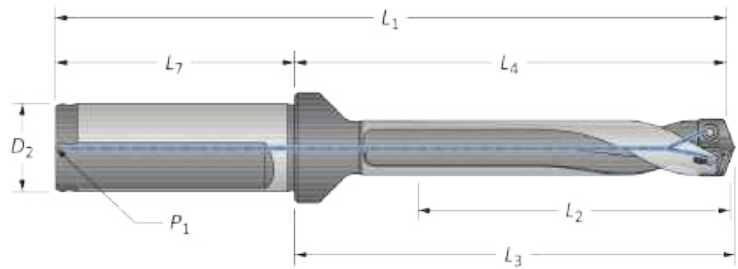

**Inserts**

Fractional Equivalent	Insert D_1 inch	D_1 mm	 XTST Part No.
–	0.4724	12.00	XTST12-12.00

**Holders**

	Length	Body				Shank				Part No.
		L_2	L_4	L_3	L_1	L_7	D_2	P_1	Flat	
i	1.5xD	0.766	1.859	1.938	3.891	2.031	3/4	1/8 NPT	YES	ST01120-075F
	3xD	1.531	2.625	2.703	4.656	2.031	3/4	1/8 NPT	YES	ST03120-075F
	5xD	2.563	3.641	3.734	5.672	2.031	3/4	1/8 NPT	YES	ST05120-075F
	7xD	3.578	4.672	4.750	6.688	2.031	3/4	1/8 NPT	YES	ST07120-075F
m	1.5xD	19.5	47.1	49.3	97.1	50.0	20	1/8 BSPT	YES	ST01120-20FM
	3xD	39.0	66.6	68.8	116.6	50.0	20	1/8 BSPT	YES	ST03120-20FM
	5xD	65.0	92.6	94.8	142.6	50.0	20	1/8 BSPT	YES	ST05120-20FM
	7xD	90.9	118.5	120.8	168.6	50.0	20	1/8 BSPT	YES	ST07120-20FM

Connection Accessories

 Insert Screws	 Nylon Locking Screws	 Insert Driver	 Preset Torque Hand Driver	 Replacement Tips	Admissible Tightening Torque*
7247-IP7-1	7247N-IP7-1	8IP-7	8IP-7TL	8IP-7B	7.4 in-lbs (84 N-cm)

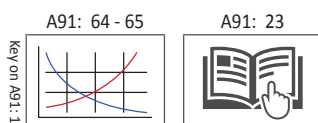
*Tightening torques are calculated with a friction coefficient of $\mu = 0.14$ and develop 90% of ultimate yield strength.**i** = Imperial (in)
m = Metric (mm)

Inserts sold in multiples of 1 | Screws sold in multiples of 10.

NOTICE: Structural steel GEN3SYS holders are specifically designed to be used only with GEN3SYS XT Pro structural steel geometry inserts. Using other GEN3SYS XT or XT Pro insert geometries in these holders could lead to chip packing and tool failure.
Contact Application Engineering for questions regarding proper use of tools. ext: 7611 | email: appeng@alliedmachine.com



GEN3SYS® XT Pro Structural Steel Drilling System

13 Series | Diameter Range: 0.5118" - 0.5511" (13.00 mm - 13.99 mm)

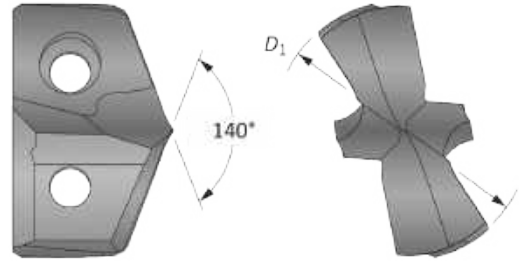

Inserts



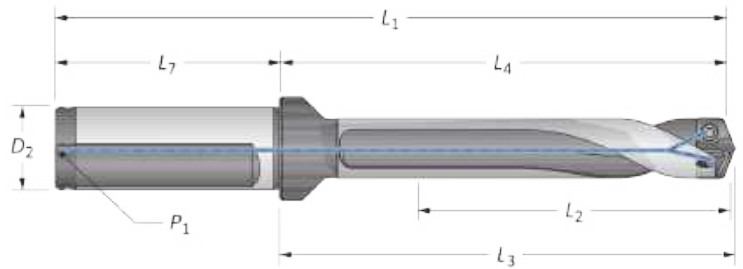

Fractional Equivalent	Insert D_1 inch	D_1 mm	 XTST Part No.
-	0.5118	13.00	XTST13-13.00



Holders

	Length	Body				Shank				Part No.
		L_2	L_4	L_3	L_1	L_7	D_2	P_1	Flat	
i	1.5xD	0.828	1.891	1.984	3.922	2.031	3/4	1/8 NPT	YES	ST01130-075F
	3xD	1.656	2.719	2.813	4.750	2.031	3/4	1/8 NPT	YES	ST03130-075F
	5xD	2.750	3.828	3.906	5.859	2.031	3/4	1/8 NPT	YES	ST05130-075F
	7xD	3.859	4.938	5.031	6.969	2.031	3/4	1/8 NPT	YES	ST07130-075F
m	1.5xD	21.1	48.1	50.3	99.7	50.0	20	1/8 BSPT	YES	ST01130-20FM
	3xD	42.1	69.1	71.3	120.7	50.0	20	1/8 BSPT	YES	ST03130-20FM
	5xD	69.9	97.2	99.4	148.8	50.0	20	1/8 BSPT	YES	ST05130-20FM
	7xD	97.9	125.4	127.6	177.0	50.0	20	1/8 BSPT	YES	ST07130-20FM

Connection Accessories

 Insert Screws	 Nylon Locking Screws	 Insert Driver	 Preset Torque Hand Driver	 Replacement Tips	Admissible Tightening Torque*
7247-IP7-1	7247N-IP7-1	8IP-7	8IP-7TL	8IP-7B	7.4 in-lbs (84 N-cm)

*Tightening torques are calculated with a friction coefficient of $\mu = 0.14$ and develop 90% of ultimate yield strength.

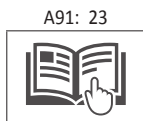
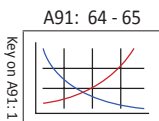

i = Imperial (in)
m = Metric (mm)

Inserts sold in multiples of 1. | Screws sold in multiples of 10.

NOTICE: Structural steel GEN3SYS holders are specifically designed to be used only with GEN3SYS XT Pro structural steel geometry inserts. Using other GEN3SYS XT or XT Pro insert geometries in these holders could lead to chip packing and tool failure.
Contact Application Engineering for questions regarding proper use of tools. ext: 7611 | email: appeng@alliedmachine.com

**GEN3SYS® XT Pro Structural Steel Drilling System**

14 Series | Diameter Range: 0.5512" - 0.5905" (14.00 mm - 14.99 mm)

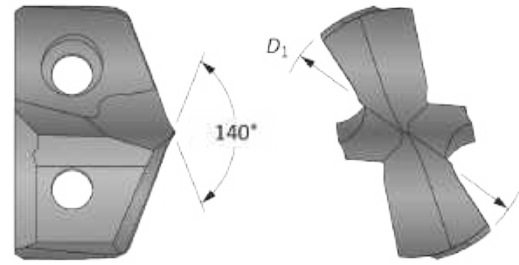

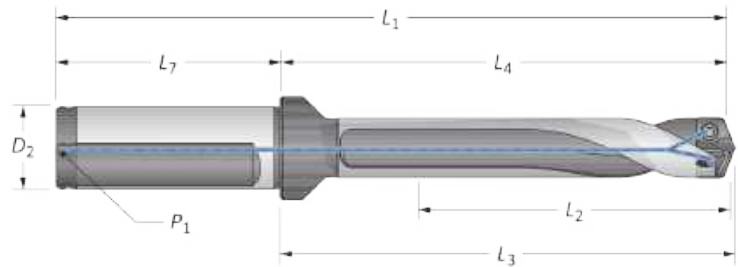

**Inserts**

Fractional Equivalent	Insert		 XTST Part No.
	D ₁ inch	D ₁ mm	
–	0.5512	14.00	XTST14-14.00
9/16	0.5626	14.29	XTST14-14.29

**Holders**

Length	Body				Shank				Part No.
	L ₂	L ₄	L ₃	L ₁	L ₇	D ₂	P ₁	Flat	
1.5xD	0.906	1.953	2.063	3.984	2.031	3/4	1/8 NPT	YES	ST01140-075F
3xD	1.781	2.844	2.953	4.875	2.031	3/4	1/8 NPT	YES	ST03140-075F
5xD	2.953	4.031	4.125	6.063	2.031	3/4	1/8 NPT	YES	ST05140-075F
7xD	4.141	5.203	5.313	7.234	2.031	3/4	1/8 NPT	YES	ST07140-075F
1.5xD	22.5	49.9	52.5	99.9	50.0	20	1/8 BSPT	YES	ST01140-20FM
3xD	45.0	72.4	75.0	122.4	50.0	20	1/8 BSPT	YES	ST03140-20FM
5xD	75.0	102.4	104.9	152.4	50.0	20	1/8 BSPT	YES	ST05140-20FM
7xD	104.9	132.3	134.9	182.3	50.0	20	1/8 BSPT	YES	ST07140-20FM

Connection Accessories

 Insert Screws	 Nylon Locking Screws	 Insert Driver	 Preset Torque Hand Driver	 Replacement Tips	Admissible Tightening Torque*
7247-IP7-1	7247N-IP7-1	8IP-7	8IP-7TL	8IP-7B	7.4 in-lbs (84 N-cm)

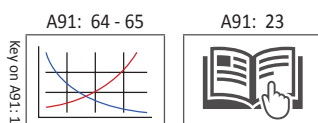
*Tightening torques are calculated with a friction coefficient of $\mu = 0.14$ and develop 90% of ultimate yield strength.

i = Imperial (in)
m = Metric (mm)

Inserts sold in multiples of 1. | Screws sold in multiples of 10.

NOTICE: Structural steel GEN3SYS holders are specifically designed to be used only with GEN3SYS XT Pro structural steel geometry inserts. Using other GEN3SYS XT or XT Pro insert geometries in these holders could lead to chip packing and tool failure.
 Contact Application Engineering for questions regarding proper use of tools. ext: 7611 | email: appeng@alliedmachine.com



GEN3SYS® XT Pro Structural Steel Drilling System

15 Series | Diameter Range: 0.5906" - 0.6298" (15.00 mm - 15.99 mm)

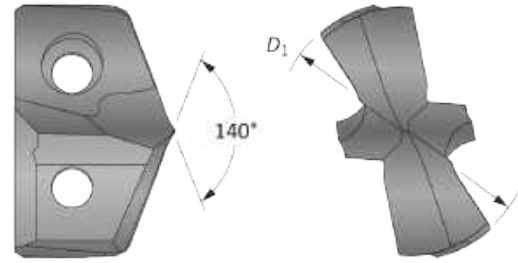

Inserts



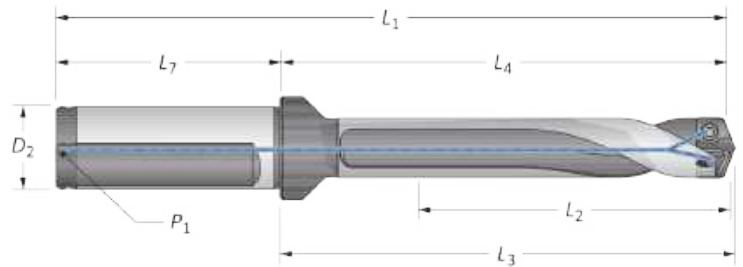

Fractional Equivalent	Insert D_1 inch	D_1 mm	 XTST Part No.
	0.5906	15.00	XTST15-15.00
5/8	0.6252	15.88	XTST15-15.88



Holders

	Length	Body				Shank				Part No.
		L_2	L_4	L_3	L_1	L_7	D_2	P_1	Flat	
i	1.5xD	0.953	2.016	2.109	4.047	2.031	3/4	1/8 NPT	YES	ST01150-075F
	3xD	1.891	2.953	3.047	4.984	2.031	3/4	1/8 NPT	YES	ST03150-075F
	5xD	3.156	4.219	4.313	6.234	2.031	3/4	1/8 NPT	YES	ST05150-075F
	7xD	4.422	5.469	5.578	7.500	2.031	3/4	1/8 NPT	YES	ST07150-075F
m	1.5xD	24.0	51.1	53.6	101.1	50.0	20	1/8 BSPT	YES	ST01150-20FM
	3xD	48.0	75.1	77.6	125.1	50.0	20	1/8 BSPT	YES	ST03150-20FM
	5xD	80.0	107.0	109.6	157.0	50.0	20	1/8 BSPT	YES	ST05150-20FM
	7xD	111.9	139.0	141.6	189.0	50.0	20	1/8 BSPT	YES	ST07150-20FM

Connection Accessories

 Insert Screws	 Nylon Locking Screws	 Insert Driver	 Preset Torque Hand Driver	 Replacement Tips	Admissible Tightening Torque*
7247-IP7-1	7247N-IP7-1	8IP-7	8IP-7TL	8IP-7B	7.4 in-lbs (84 N-cm)

*Tightening torques are calculated with a friction coefficient of $\mu = 0.14$ and develop 90% of ultimate yield strength.

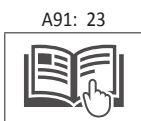
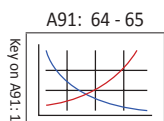

i = Imperial (in)
m = Metric (mm)

Inserts sold in multiples of 1. | Screws sold in multiples of 10.

NOTICE: Structural steel GEN3SYS holders are specifically designed to be used only with GEN3SYS XT Pro structural steel geometry inserts. Using other GEN3SYS XT or XT Pro insert geometries in these holders could lead to chip packing and tool failure.
Contact Application Engineering for questions regarding proper use of tools. ext: 7611 | email: appeng@alliedmachine.com



GEN3SYS® XT Pro Structural Steel Drilling System

16 Series | Diameter Range: 0.6299" - 0.6692" (16.00 mm - 16.99 mm)

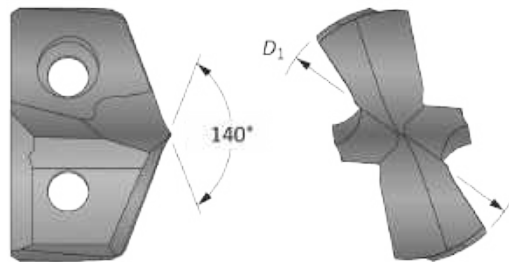
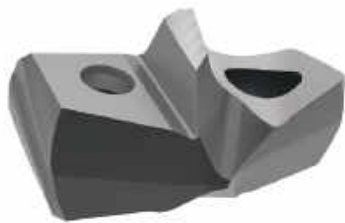

Inserts



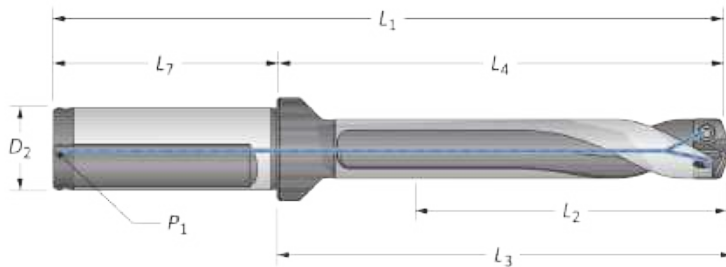

Fractional Equivalent	Insert <i>D</i> ₁ inch	<i>D</i> ₁ mm	 XTST Part No.
–	0.6299	16.00	XTST16-16.00



Holders

Length	Body				Shank				Part No.	
	<i>L</i> ₂	<i>L</i> ₄	<i>L</i> ₃	<i>L</i> ₁	<i>L</i> ₇	<i>D</i> ₂	<i>P</i> ₁	Flat		
i	1.5xD	1.016	2.203	2.313	4.234	2.031	3/4	1/8 NPT	YES	ST01160-075F
	3xD	3.016	3.203	3.313	5.234	2.031	3/4	1/8 NPT	YES	ST03160-075F
	5xD	3.359	4.531	4.656	6.563	2.031	3/4	1/8 NPT	YES	ST05160-075F
	7xD	4.688	5.875	5.984	7.906	2.031	3/4	1/8 NPT	YES	ST07160-075F
m	1.5xD	25.5	55.8	58.7	105.8	50.0	20	1/8 BSPT	YES	ST01160-20FM
	3xD	51.0	81.3	84.2	131.3	50.0	20	1/8 BSPT	YES	ST03160-20FM
	5xD	84.9	115.3	118.2	165.3	50.0	20	1/8 BSPT	YES	ST05160-20FM
	7xD	118.9	149.3	152.2	199.3	50.0	20	1/8 BSPT	YES	ST07160-20FM

Connection Accessories

 Insert Screws	 Nylon Locking Screws	 Insert Driver	 Preset Torque Hand Driver	 Replacement Tips	Admissible Tightening Torque*
72556-IP8-1	72556N-IP8-1	8IP-8	8IP-8TL	8IP-8B	15.5 in-lbs (175 N-cm)

*Tightening torques are calculated with a friction coefficient of $\mu = 0.14$ and develop 90% of ultimate yield strength.

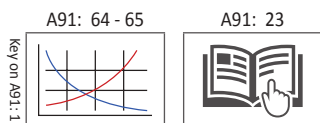

i = Imperial (in)
m = Metric (mm)

Inserts sold in multiples of 1. | Screws sold in multiples of 10.

NOTICE: Structural steel GEN3SYS holders are specifically designed to be used only with GEN3SYS XT Pro structural steel geometry inserts. Using other GEN3SYS XT or XT Pro insert geometries in these holders could lead to chip packing and tool failure.
Contact Application Engineering for questions regarding proper use of tools. ext: 7611 | email: appeng@alliedmachine.com



GEN3SYS® XT Pro Structural Steel Drilling System

17 Series | Diameter Range: 0.6693" - 0.7086" (17.00 mm - 17.99 mm)

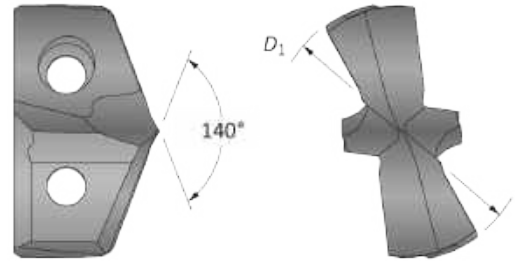

Inserts



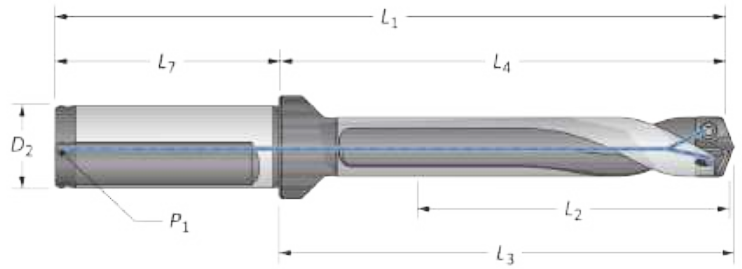

Fractional Equivalent	Insert D_1 inch	D_1 mm	 XTST Part No.
–	0.6693	17.00	XTST17-17.00
11/16	0.6876	17.46	XTST17-17.46



Holders

	Length	Body				Shank				Part No.
		L_2	L_4	L_3	L_1	L_7	D_2	P_1	Flat	
i	1.5xD	1.063	2.250	2.359	4.281	2.031	3/4	1/8 NPT	YES	ST01170-075F
	3xD	2.125	3.313	3.422	5.344	2.031	3/4	1/8 NPT	YES	ST03170-075F
	5xD	3.547	4.719	4.844	6.750	2.031	3/4	1/8 NPT	YES	ST05170-075F
	7xD	4.969	6.141	6.250	8.172	2.031	3/4	1/8 NPT	YES	ST07170-075F
m	1.5xD	27.0	57.1	60.0	107.1	50.0	20	1/8 BSPT	YES	ST01170-20FM
	3xD	54.0	84.1	87.0	134.1	50.0	20	1/8 BSPT	YES	ST03170-20FM
	5xD	89.9	120.0	122.9	170.0	50.0	20	1/8 BSPT	YES	ST05170-20FM
	7xD	125.9	156.0	158.9	206.0	50.0	20	1/8 BSPT	YES	ST07170-20FM

Connection Accessories

 Insert Screws	 Nylon Locking Screws	 Insert Driver	 Preset Torque Hand Driver	 Replacement Tips	Admissible Tightening Torque*
72567-IP8-1	72567N-IP8-1	8IP-8	8IP-8TL	8IP-8B	15.5 in-lbs (175 N-cm)

*Tightening torques are calculated with a friction coefficient of $\mu = 0.14$ and develop 90% of ultimate yield strength.

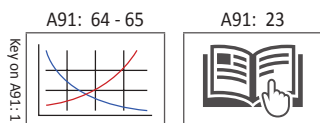

i = Imperial (in)
m = Metric (mm)

Inserts sold in multiples of 1. | Screws sold in multiples of 10.

NOTICE: Structural steel GEN3SYS holders are specifically designed to be used only with GEN3SYS XT Pro structural steel geometry inserts. Using other GEN3SYS XT or XT Pro insert geometries in these holders could lead to chip packing and tool failure.
Contact Application Engineering for questions regarding proper use of tools. ext: 7611 | email: appeng@alliedmachine.com

**GEN3SYS® XT Pro Structural Steel Drilling System**

18 Series | Diameter Range: 0.7087" - 0.7873" (18.00 mm - 19.99 mm)

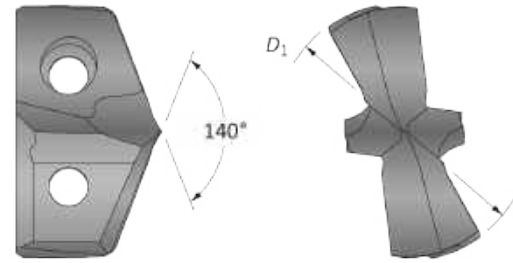

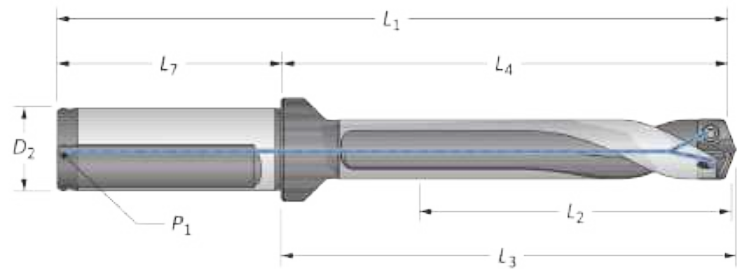

**Inserts**

Fractional Equivalent	Insert		 XTST Part No.
	D ₁ inch	D ₁ mm	
-	0.7087	18.00	XTST18-18.00
-	0.7480	19.00	XTST18-19.00

**Holders**

Length	Body				Shank				Flat	Part No.
	L ₂	L ₄	L ₃	L ₁	L ₇	D ₂	P ₁			
i	1.5xD	1.188	2.531	2.641	4.797	2.281	1	1/8 NPT	YES	ST01180-100F
	3xD	2.375	3.703	3.828	5.984	2.281	1	1/8 NPT	YES	ST03180-100F
	5xD	3.938	5.281	5.391	7.563	2.281	1	1/8 NPT	YES	ST05180-100F
	7xD	5.516	6.844	6.969	9.125	2.281	1	1/8 NPT	YES	ST07180-100F
m	1.5xD	30.0	64.0	67.1	114.0	50.0	20	1/8 BSPT	YES	ST01180-20FM
	3xD	60.0	94.0	97.1	144.0	50.0	20	1/8 BSPT	YES	ST03180-20FM
	5xD	99.9	134.0	137.1	184.0	50.0	20	1/8 BSPT	YES	ST05180-20FM
	7xD	139.9	174.0	177.1	224.0	50.0	20	1/8 BSPT	YES	ST07180-20FM

Connection Accessories

 Insert Screws	 Nylon Locking Screws	 Insert Driver	 Preset Torque Hand Driver	 Replacement Tips	Admissible Tightening Torque*
7375-IP9-1	7375N-IP9-1	8IP-9	8IP-9TL	8IP-9B	

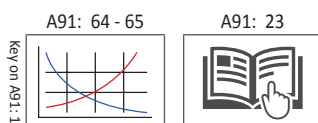
*Tightening torques are calculated with a friction coefficient of $\mu = 0.14$ and develop 90% of ultimate yield strength.**i** = Imperial (in)
m = Metric (mm)

Inserts sold in multiples of 1. | Screws sold in multiples of 10.

NOTICE: Structural steel GEN3SYS holders are specifically designed to be used only with GEN3SYS XT Pro structural steel geometry inserts. Using other GEN3SYS XT or XT Pro insert geometries in these holders could lead to chip packing and tool failure.
Contact Application Engineering for questions regarding proper use of tools. ext: 7611 | email: appeng@alliedmachine.com



GEN3SYS® XT Pro Structural Steel Drilling System

20 Series | Diameter Range: 0.7874" - 0.8660" (20.00 mm - 21.99 mm)

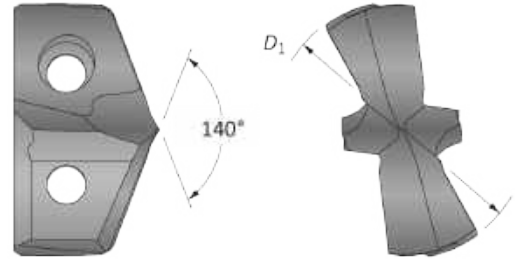

Inserts



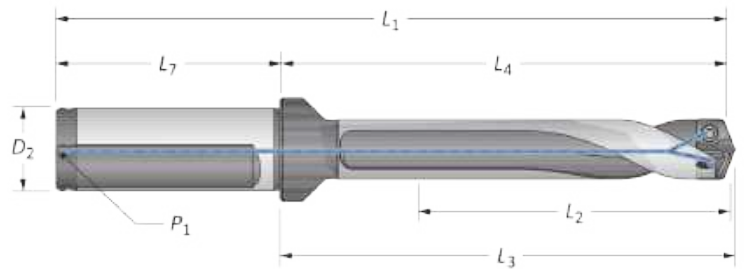

Fractional Equivalent	Insert D_1 inch	D_1 mm	 XTST Part No.
-	0.7874	20.00	XTST20-20.00
13/16	0.8126	20.64	XTST20-20.64
-	0.8268	21.00	XTST20-21.00
-	0.8591	21.82	XTST20-21.82



Holders

	Length	Body				Shank				Part No.
		L_2	L_4	L_3	L_1	L_7	D_2	P_1	Flat	
i	1.5xD	1.234	2.641	2.766	4.922	2.281	1	1/8 NPT	YES	ST01200-100F
	3xD	2.531	3.938	4.063	6.219	2.281	1	1/8 NPT	YES	ST03200-100F
	5xD	4.344	5.672	5.797	7.953	2.281	1	1/8 NPT	YES	ST05200-100F
	7xD	6.063	7.406	7.531	9.688	2.281	1	1/8 NPT	YES	ST07200-100F
m	1.5xD	33.0	67.1	70.3	123.1	56.0	25	1/8 BSPT	YES	ST01200-25FM
	3xD	66.0	100.1	103.3	156.1	56.0	25	1/8 BSPT	YES	ST03200-25FM
	5xD	110.0	144.1	147.2	200.1	56.0	25	1/8 BSPT	YES	ST05200-25FM
	7xD	153.9	188.1	191.2	244.1	56.0	25	1/8 BSPT	YES	ST07200-25FM

Connection Accessories

 Insert Screws	 Nylon Locking Screws	 Insert Driver	 Preset Torque Hand Driver	 Replacement Tips	Admissible Tightening Torque*
7375-IP9-1	7375N-IP9-1	8IP-9	8IP-9TL	8IP-9B	

*Tightening torques are calculated with a friction coefficient of $\mu = 0.14$ and develop 90% of ultimate yield strength.

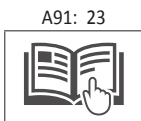
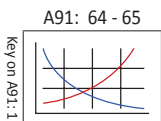

i = Imperial (in)
m = Metric (mm)

Inserts sold in multiples of 1. | Screws sold in multiples of 10.

NOTICE: Structural steel GEN3SYS holders are specifically designed to be used only with GEN3SYS XT Pro structural steel geometry inserts. Using other GEN3SYS XT or XT Pro insert geometries in these holders could lead to chip packing and tool failure.
Contact Application Engineering for questions regarding proper use of tools. ext: 7611 | email: appeng@alliedmachine.com



A
DRILLING

GEN3SYS® XT Pro Structural Steel Drilling System

22 Series | Diameter Range: 0.8661" - 0.9448" (22.00 mm - 23.99 mm)

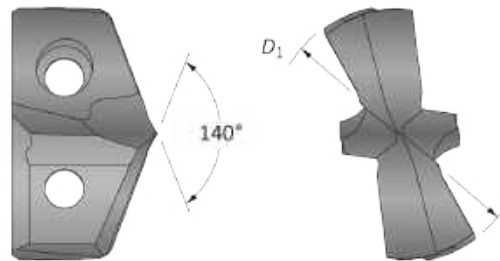

Inserts

Fractional Equivalent	Insert D_1 inch	D_1 mm	XTST Part No.
-	0.8661	22.00	XTST22-22.00
7/8	0.8752	22.23	XTST22-22.23
-	0.9055	23.00	XTST22-23.00
15/16	0.9374	23.81	XTST22-23.81

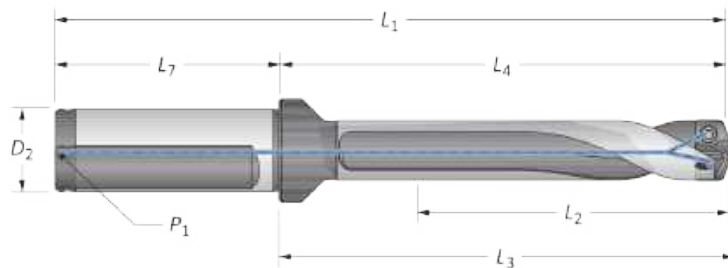

Holder

Length	Body				Shank				Part No.
	L_2	L_4	L_3	L_1	L_7	D_2	P_1	Flat	
1.5xD	1.406	2.719	2.859	5.000	2.281	1	1/8 NPT	YES	ST01220-100F
1.5xD	1.406	2.719	2.859	5.000	2.281	1	1/8 NPT	YES	ST01225-100F
3xD	2.828	4.141	4.281	6.422	2.281	1	1/8 NPT	YES	ST03220-100F
3xD	2.828	4.141	4.281	6.422	2.281	1	1/8 NPT	YES	ST03225-100F*
5xD	4.719	6.031	6.172	8.313	2.281	1	1/8 NPT	YES	ST05220-100F
5xD	4.719	6.031	6.172	8.313	2.281	1	1/8 NPT	YES	ST05225-100F*
7xD	6.609	7.922	8.063	10.203	2.281	1	1/8 NPT	YES	ST07220-100F
7xD	6.609	7.922	8.063	10.203	2.281	1	1/8 NPT	YES	ST07225-100F*
1.5xD	36.0	69.3	72.7	125.3	56.0	25	1/8 BSPT	YES	ST01220-25FM
1.5xD	36.0	69.3	72.7	125.3	56.0	25	1/8 BSPT	YES	ST01225-25FM
3xD	72.0	105.3	108.7	161.3	56.0	25	1/8 BSPT	YES	ST03220-25FM
3xD	72.0	105.3	108.7	161.3	56.0	25	1/8 BSPT	YES	ST03225-25FM*
5xD	119.9	153.3	156.7	209.3	56.0	25	1/8 BSPT	YES	ST05220-25FM
5xD	119.9	153.3	156.7	209.3	56.0	25	1/8 BSPT	YES	ST05225-25FM*
7xD	167.9	201.3	204.7	257.3	56.0	25	1/8 BSPT	YES	ST07220-25FM
7xD	167.9	201.3	204.7	257.3	56.0	25	1/8 BSPT	YES	ST07225-25FM*

*Oversized body holder (minimum drill diameter = 23 mm)

Connection Accessories

Insert Screws	Nylon Locking Screws	Insert Driver	Preset Torque Hand Driver	Replacement Tips	Admissible Tightening Torque*
739-IP9-1	739N-IP9-1	8IP-9	8IP-9TL	8IP-9B	27.0 in-lbs (305 N-cm)

*Tightening torques are calculated with a friction coefficient of $\mu = 0.14$ and develop 90% of ultimate yield strength.

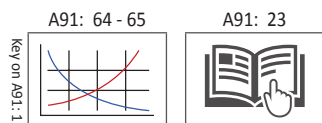

i = Imperial (in)
m = Metric (mm)

Inserts sold in multiples of 1. | Screws sold in multiples of 10.

NOTICE: Structural steel GEN3SYS holders are specifically designed to be used only with GEN3SYS XT Pro structural steel geometry inserts. Using other GEN3SYS XT or XT Pro insert geometries in these holders could lead to chip packing and tool failure.
Contact Application Engineering for questions regarding proper use of tools. ext: 7611 | email: appeng@alliedmachine.com

B
BORING

C
REAMING

D
BURNISHING

E
THREADING

X
SPECIALS

GEN3SYS® XT Pro Structural Steel Drilling System

24 Series | Diameter Range: 0.9449" - 1.0235" (24.00 mm - 25.99 mm)

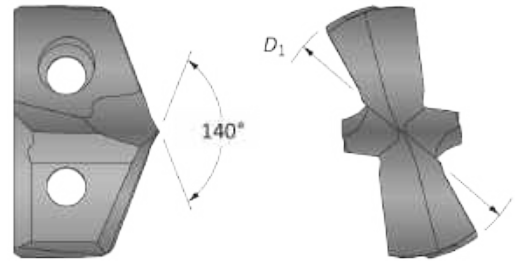

Inserts



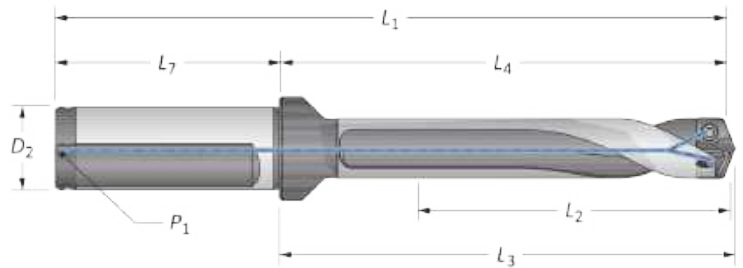

Fractional Equivalent	Insert D_1 inch	D_1 mm	 XTST Part No.
-	0.9449	24.00	XTST24-24.00
-	0.9685	24.60	XTST24-24.60
1	1.0000	25.40	XTST24-25.40
-	1.0150	25.78	XTST24-25.78



Holders

Length	Body				Shank				Part No.
	L_2	L_4	L_3	L_1	L_7	D_2	P_1	Flat	
i 1.5xD	1.547	2.953	3.094	5.234	2.281	1	1/8 NPT	YES	ST01240-100F
3xD	3.078	4.484	4.625	6.766	2.281	1	1/8 NPT	YES	ST03240-100F
5xD	5.125	6.531	6.656	8.813	2.281	1	1/8 NPT	YES	ST05240-100F
7xD	7.172	8.578	8.703	10.859	2.281	1	1/8 NPT	YES	ST07240-100F
m 1.5xD	39.0	74.8	78.3	130.8	56.0	25	1/8 BSPT	YES	ST01240-25FM
3xD	78.0	113.8	117.3	169.8	56.0	25	1/8 BSPT	YES	ST03240-25FM
5xD	129.9	165.8	169.2	221.8	56.0	25	1/8 BSPT	YES	ST05240-25FM
7xD	181.9	217.8	221.2	273.8	56.0	25	1/8 BSPT	YES	ST07240-25FM

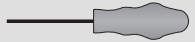
Connection Accessories

 Insert Screws	 Nylon Locking Screws	 Insert Driver	 Preset Torque Hand Driver	 Replacement Tips	Admissible Tightening Torque*
739-IP9-1	739N-IP9-1	8IP-9	8IP-9TL	8IP-9B	27.0 in-lbs (305 N-cm)

*Tightening torques are calculated with a friction coefficient of $\mu = 0.14$ and develop 90% of ultimate yield strength.

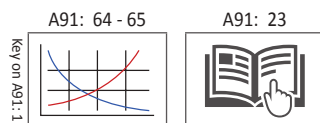

i = Imperial (in)
m = Metric (mm)

Inserts sold in multiples of 1. | Screws sold in multiples of 10.

NOTICE: Structural steel GEN3SYS holders are specifically designed to be used only with GEN3SYS XT Pro structural steel geometry inserts. Using other GEN3SYS XT or XT Pro insert geometries in these holders could lead to chip packing and tool failure.
Contact Application Engineering for questions regarding proper use of tools. ext: 7611 | email: appeng@alliedmachine.com



GEN3SYS® XT Pro Structural Steel Drilling System

26 Series | Diameter Range: 1.0236" - 1.1416" (26.00 mm - 28.99 mm)

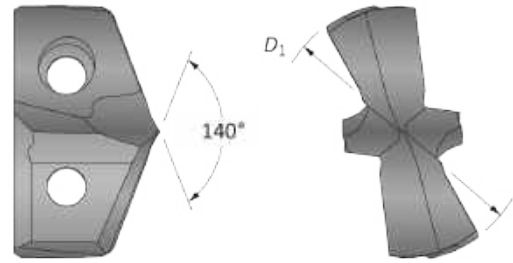

Inserts



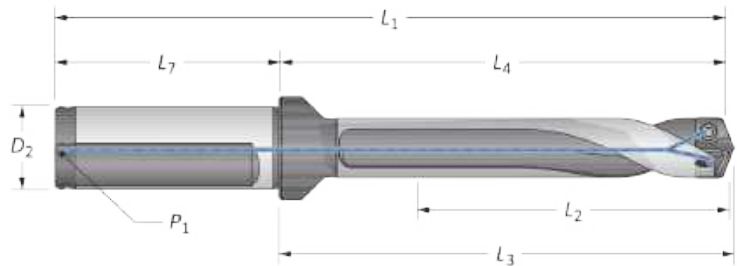

Fractional Equivalent	Insert D_1 inch	D_1 mm	 XTST Part No.
-	1.0236	26.00	XTST26-26.00
1-1/16	1.0626	26.99	XTST26-26.99
-	1.0630	27.00	XTST26-27.00
-	1.1024	28.00	XTST26-28.00
1-1/8	1.1252	28.58	XTST26-28.58



Holders

Length	Body					Shank				Part No.
	L_2	L_4	L_3	L_1	L_7	D_2	P_1	Flat		
i	1.5xD	1.703	3.344	3.469	5.625	2.281	1-1/4	1/4 NPT	YES	ST01260-125F
	3xD	3.422	5.063	5.188	7.344	2.281	1-1/4	1/4 NPT	YES	ST03260-125F
	5xD	5.719	7.344	7.484	9.625	2.281	1-1/4	1/4 NPT	YES	ST05260-125F
	7xD	7.984	9.625	9.766	11.906	2.281	1-1/4	1/4 NPT	YES	ST07260-125F
m	1.5xD	43.5	84.6	87.9	144.6	60.0	32	1/4 BSPT	YES	ST01260-32FM
	3xD	87.0	128.1	131.4	188.1	60.0	32	1/4 BSPT	YES	ST03260-32FM
	5xD	145.0	186.1	189.4	246.1	60.0	32	1/4 BSPT	YES	ST05260-32FM
	7xD	202.9	244.0	247.4	304.0	60.0	32	1/4 BSPT	YES	ST07260-32FM

Connection Accessories

 Insert Screws	 Nylon Locking Screws	 Insert Driver	 Preset Torque Hand Driver	 Replacement Tips	Admissible Tightening Torque*
7495-IP15-1	7495N-IP15-1	8IP-15	8IP-15TL	8IP-15B	61.0 in-lbs (690 N-cm)

*Tightening torques are calculated with a friction coefficient of $\mu = 0.14$ and develop 90% of ultimate yield strength.

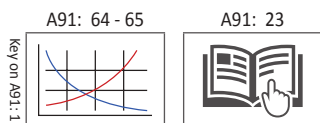

i = Imperial (in)
m = Metric (mm)

Inserts sold in multiples of 1. | Screws sold in multiples of 10.

NOTICE: Structural steel GEN3SYS holders are specifically designed to be used only with GEN3SYS XT Pro structural steel geometry inserts. Using other GEN3SYS XT or XT Pro insert geometries in these holders could lead to chip packing and tool failure. Contact Application Engineering for questions regarding proper use of tools. ext: 7611 | email: appeng@alliedmachine.com



GEN3SYS® XT Pro Structural Steel Drilling System

29 Series | Diameter Range: 1.1417" - 1.2597" (29.00 mm - 31.99 mm)

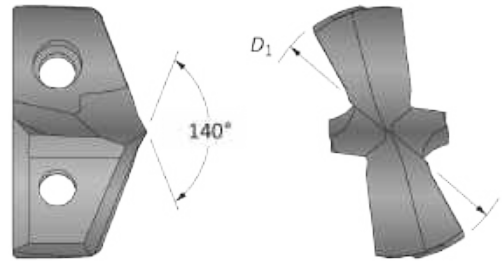

Inserts



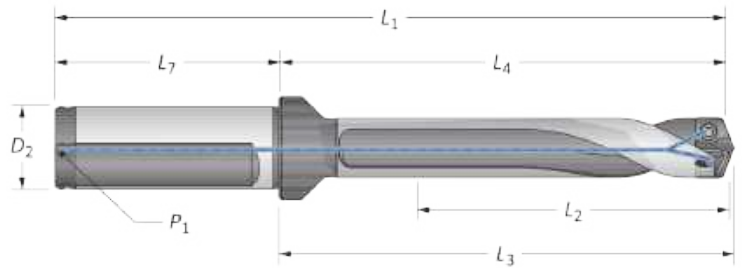

Fractional Equivalent	Insert D_1 inch	D_1 mm	 XTST Part No.
–	1.1417	29.00	XTST29-29.00
–	1.1811	30.00	XTST29-30.00
1-3/16	1.1874	30.16	XTST29-30.16
–	1.2205	31.00	XTST29-31.00
1-1/4	1.2500	31.75	XTST29-31.75



Holders

Length	Body				Shank				Part No.	
	L_2	L_4	L_3	L_1	L_7	D_2	P_1	Flat		
i	1.5xD	1.891	3.328	3.625	5.766	2.281	1-1/4	1/4 NPT	YES	ST01290-125F
	3xD	3.781	5.375	5.516	7.656	2.281	1-1/4	1/4 NPT	YES	ST03290-125F
	5xD	6.297	7.906	8.047	10.188	2.281	1-1/4	1/4 NPT	YES	ST05290-125F
	7xD	8.813	10.422	10.563	12.703	2.281	1-1/4	1/4 NPT	YES	ST07290-125F
m	1.5xD	48.0	88.2	91.7	148.2	60.0	32	1/4 BSPT	YES	ST01290-32FM
	3xD	96.0	136.2	139.7	196.2	60.0	32	1/4 BSPT	YES	ST03290-32FM
	5xD	159.9	200.1	203.7	260.1	60.0	32	1/4 BSPT	YES	ST05290-32FM
	7xD	223.9	264.1	267.7	324.1	60.0	32	1/4 BSPT	YES	ST07290-32FM

Connection Accessories

 Insert Screws	 Nylon Locking Screws	 Insert Driver	 Preset Torque Hand Driver	 Replacement Tips	Admissible Tightening Torque*
7495-IP15-1	7495N-IP15-1	8IP-15	8IP-15TL	8IP-15B	61.0 in-lbs (690 N-cm)

*Tightening torques are calculated with a friction coefficient of $\mu = 0.14$ and develop 90% of ultimate yield strength.

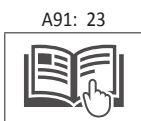
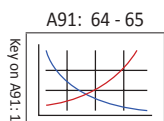

i = Imperial (in)
m = Metric (mm)

Inserts sold in multiples of 1. | Screws sold in multiples of 10.

NOTICE: Structural steel GEN3SYS holders are specifically designed to be used only with GEN3SYS XT Pro structural steel geometry inserts. Using other GEN3SYS XT or XT Pro insert geometries in these holders could lead to chip packing and tool failure.
Contact Application Engineering for questions regarding proper use of tools. ext: 7611 | email: appeng@alliedmachine.com

**GEN3SYS® XT Pro Structural Steel Drilling System**

32 Series | Diameter Range: 1.2598" - 1.3780" (32.00 mm - 35.00 mm)

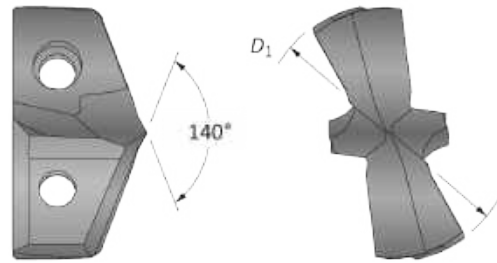

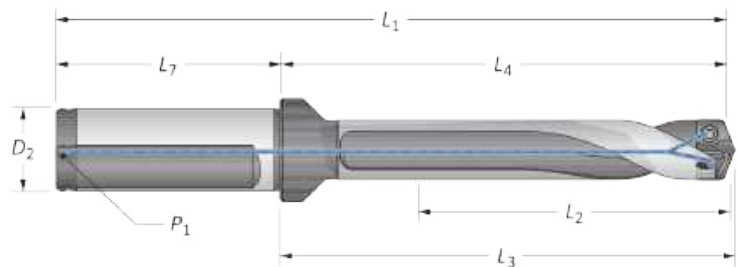

**Inserts**

Fractional Equivalent	Insert	D_1 inch	D_1 mm	 XTST Part No.
-		1.2598	32.00	XTST32-32.00
-		1.2992	33.00	XTST32-33.00
1-5/16		1.3126	33.34	XTST32-33.34
-		1.3386	34.00	XTST32-34.00
1-3/8		1.3752	34.93	XTST32-34.93

**Holders**

Length	Body				Shank				Flat	Part No.
	L_2	L_4	L_3	L_1	L_7	D_2	P_1			
i	1.5xD	2.078	4.156	4.313	6.828	2.688	1-1/2	1/4 NPT	YES	ST01320-150F
	3xD	4.141	6.219	6.375	8.891	2.688	1-1/2	1/4 NPT	YES	ST03320-150F
	5xD	6.922	8.969	9.125	11.656	2.688	1-1/2	1/4 NPT	YES	ST05320-150F
	7xD	9.641	11.719	11.891	14.406	2.688	1-1/2	1/4 NPT	YES	ST07320-150F
m	1.5xD	52.5	105.2	109.5	165.2	60.0	32	1/4 BSPT	YES	ST01320-32FM
	1.5xD	52.5	105.2	109.5	173.5	70.0	40	1/4 BSPT	YES	ST01320-40FM
	3xD	105.0	157.7	162.0	217.7	60.0	32	1/4 BSPT	YES	ST03320-32FM
	3xD	105.0	157.7	162.0	227.7	70.0	40	1/4 BSPT	YES	ST03320-40FM
	5xD	175.0	227.7	232.0	287.7	60.0	32	1/4 BSPT	YES	ST05320-32FM
	5xD	175.0	227.7	232.0	297.7	70.0	40	1/4 BSPT	YES	ST05320-40FM
	7xD	244.9	297.7	302.2	357.7	60.0	32	1/4 BSPT	YES	ST07320-32FM
	7xD	244.9	297.7	302.0	367.7	70.0	40	1/4 BSPT	YES	ST07320-40FM

Connection Accessories

					Admissible Tightening Torque*
Insert Screws 7495-IP15-1	Nylon Locking Screws 7495N-IP15-1	Insert Driver 8IP-15	Preset Torque Hand Driver 8IP-15TL	Replacement Tips 8IP-15B	61.0 in-lbs (690 N-cm)

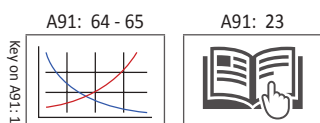
*Tightening torques are calculated with a friction coefficient of $\mu = 0.14$ and develop 90% of ultimate yield strength.**i** = Imperial (in)
m = Metric (mm)

Inserts sold in multiples of 1. | Screws sold in multiples of 10.

NOTICE: Structural steel GEN3SYS holders are specifically designed to be used only with GEN3SYS XT Pro structural steel geometry inserts. Using other GEN3SYS XT or XT Pro insert geometries in these holders could lead to chip packing and tool failure.
Contact Application Engineering for questions regarding proper use of tools. ext: 7611 | email: appeng@alliedmachine.com

4TEX® Drill Safety Information



Mechanical / Physical Hazards

Operating cutting tools may present both mechanical and physical hazards. These hazards can result in serious injury to workers or those near machines and damage to machines and the cutting tools. Cutting tools and/or assemblies may break or come loose when in operation causing projectile metal fragments. Metal chips produced by cutting tools have sharp edges and may be very hot. To minimize the risk of mechanical or physical hazards:

- Always secure all components of the cutting tool assembly before operating.
- Wear cut-resistant gloves when handling cutting tool components and assemblies.
- Do not touch metal chips produced by the cutting tools with your hands.
- Always wear appropriate personal protective equipment including safety goggles or glasses with side shields.
- Immediately discontinue use of damaged cutting tools.
- To avoid machine tool damage, make sure the machine has adequate power and torque for the cutting tool when operating. See catalog for power and torque requirements.
- Operating long cutting tools at high spindle speeds can result in a high risk of tool failure and serious injury.

Dust and Fume Hazards

Grinding, welding, cutting or burning hard metals such as high-speed steel, cobalt or carbides produces hazardous dust and/or fumes. Continued long-term exposure to hazardous dust and fumes can cause serious health issues. To minimize the risk of dust and fume hazards:

- Do not regrind or sharpen cutting tools without using adequate ventilation.
- Use appropriate personal protective equipment such as approved respirator to avoid inhalation, swallowing, or skin contact with the hazardous dust and/or fumes.
- Do not eat, drink, or smoke in the machine operation area. Always wash skin prior to eating, drinking, or smoking to avoid hazardous ingestion.

Sensitizing Hazards

Components of an assembled cutting tool are made from a variety of metal elements that may cause allergic skin reactions with prolonged skin contact. To minimize the risk of allergic skin reactions:

- Avoid skin contact with cutting tools.
- Wear appropriate gloves and protective clothing.
- Wash skin and launder clothing after handling cutting tools to reduce the risk of skin allergies.

Preventive Safety Measure Applicable to all Hazards

- Prior to using cutting tools, always read Allied Machine's Safety Data Sheets, product catalog, and product labels for additional warnings for the Allied Machine product being used.
- For machining safety, only operate equipment when all necessary guards, interlocks and other safety devices are in place and functional. Use all appropriate safety guards or machine encapsulations to securely collect particles such as chips or cutting elements that may become projectiles.

Through Hole

- With through holes, a **sharp-edged disk** is created as tool breakout occurs.
 - Proper personal protective equipment must be used to prevent injury (e.g. wear cut-resistant gloves).





4TEX® Drilling System

4TEX Drill **Advantages**

- ✓ **Superior chip evacuation**
provided by the two twisted coolant holes
- ✓ **Improved hole size**
from the increased holder rigidity
- ✓ **Longer tool life**
provided by the four-sided insert design
- ✓ **Optimal chip formation**
with ISO-specific insert geometry/coating combinations
- ✓ **Competitive cycle times**
due to single effective cutting when using light duty machines

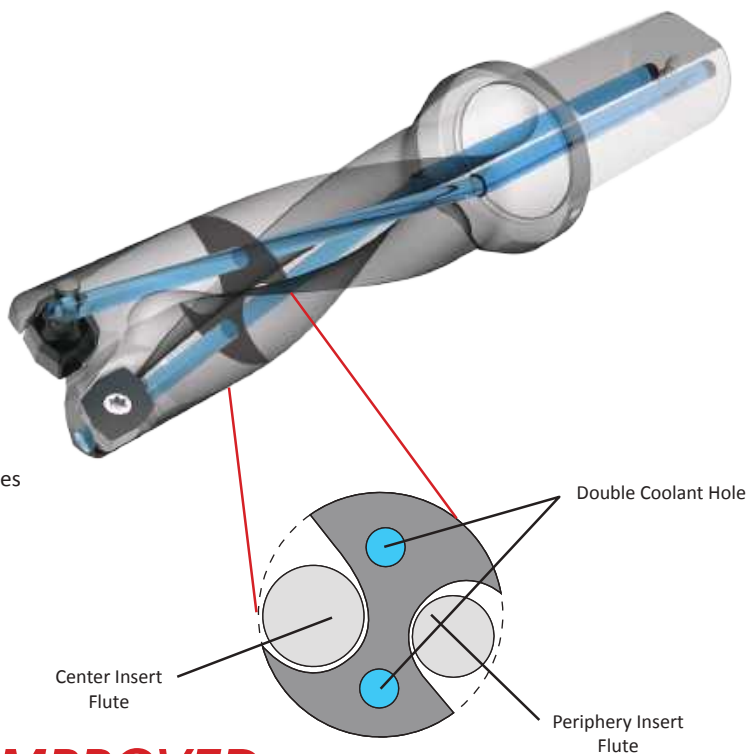

DESIGNED TO GIVE YOU **IMPROVED** HOLE SIZE AND STRAIGHTNESS

- The two twisted coolant holes allow the core to remain intact, making the core thicker and stronger for improved hole straightness even in uneven surfaces.
- The enlarged dual coolant outlets increase the coolant volume, which improves the chip evacuation resulting in improved hole size.
- The flute space of the internal cutting edge side (where chips get stuck most often) is 1.6x larger than typical IC drills, helping to mitigate catastrophic failures and improves hole sizes.

LONGER TOOL LIFE



AVAILABLE **LENGTHS**

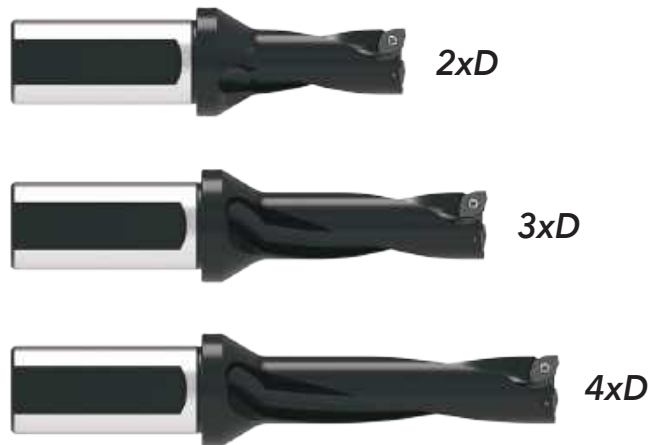

A
DRILLING
B
BORING
C
REAMING
D
BURNISHING
E
THREADING
X
SPECIALS



Insert Information

4 CUTTING EDGES

- Each insert has two inner cutting edges and two outer cutting edges.
- Economical solution that increases tool life because of the ability to rotate the inserts.
- Available in ISO material-specific geometry/coating combinations.

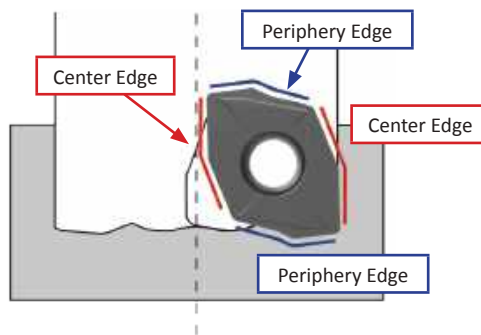

Periphery Insert



Periphery edge chip formation:



Center Insert



Center edge chip formation:





ISO Material	Geometry	Coating	Description
P	General Rake	AM480	A general purpose geometry that provides excellent chip formation in most steels including free-machining, medium- and high-carbon steels. A P30 carbide substrate for improved toughness and AM480 coating, a proprietary wear resistant multilayer PVD coating to improve tool life.
S M	High Rake	AM485	A higher rake geometry that provides excellent chip formation in both stainless steels and high-temperature alloys. A tough M25 carbide substrate coated with AM485, a high heat resistance proprietary multilayer PVD coating.
H	Low Rake	AM480	A lower rake geometry to improve edge strength in both hardened tool steels and high-strength alloys. With a P30 carbide substrate for improved toughness and coated with AM480, a proprietary multilayer PVD coating to improve resistance against tool wear.
K	General Rake	AM480	With a general purpose geometry, the K inserts can be used in grey cast irons as well as ductile irons. A high wear-resistant K10 carbide substrate to improve tool life and coated with AM480, a proprietary multilayer PVD coating to improve resistance against tool wear.
N	High Rake	TiCN	A higher rake cutting geometry provides excellent chip formation in nonferrous materials. An M15/K15 carbide substrate paired with TiCN coating for improved lubricity to resist built-up material, increasing tool life and maintaining chip formation.

A DRILLING
B BORING
C REAMING
D BURNISHING
E THREADING
X SPECIALS



Insert Information

Series	Insert Prefix	Dimension (mm)					Angle		Shape
		L_1	L_2	T	D_1	R	A_1	A_2	
03	4T-030203C-x	5.60	4.80	2.30	2.40	0.30	7°	10°	 Style 1
	4T-030203P-x	6.38	4.77	2.30	2.40	0.30	7°	10°	 Style 2
04	4T-040203-x	6.21	5.06	2.60	2.45	0.30	13°	10°	 Style 3
05	4T-05T203-x	7.26	5.48	2.76	2.55	0.30	13°	7°	
06	4T-06T204-x	8.59	6.44	2.89	2.79	0.40	13°	7°	
07	4T-070305-x	10.21	8.02	3.24	3.00	0.50	13°	7°	
09	4T-09T306-x	12.18	9.55	4.03	3.64	0.60	13°	7°	
11	4T-11T306-x	14.50	11.61	4.06	4.62	0.60	13°	7°	
14	4T-140408-x	17.99	14.40	4.88	5.76	0.80	13°	7°	

Style 1

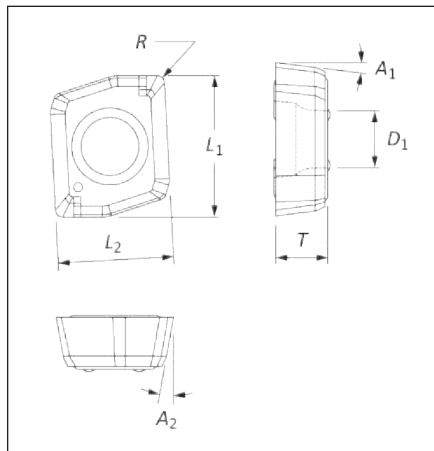

Style 2

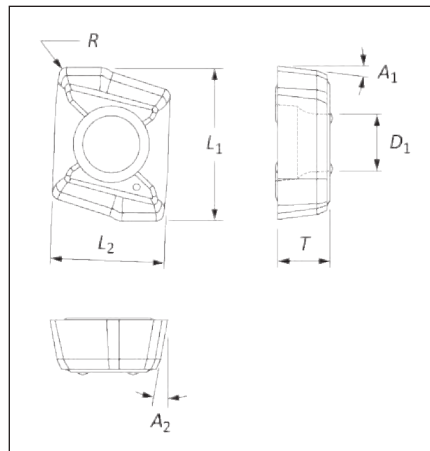

Style 3

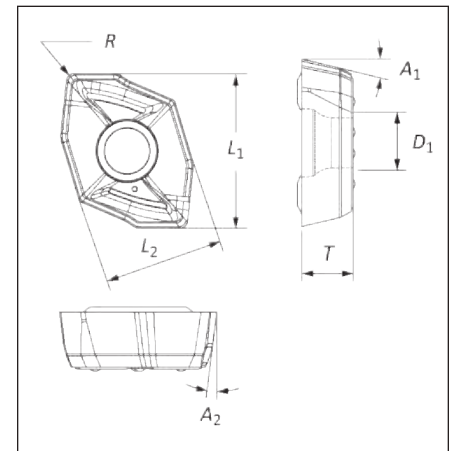

4TEX® Drill Interrupted Cuts

(DON'T) PARDON THE INTERRUPTION

The 4TEX drill is the premium solution when the cut is interrupted. The indexable carbide insert design provides multiple points of stability, so the entire cutting edge does not require engagement while still providing the hole quality required.



QUICK TROUBLESHOOTING

	<p>Starting on Angled Surfaces</p> <ul style="list-style-type: none"> • Reduce entry feed by 20 - 50%. • Use lower rake geometry if insert chipping occurs.
	<p>Angled Bore Exit</p> <ul style="list-style-type: none"> • Reduce entry feed by 50% on breakout. • Use tough insert and stable corner radius.
	<p>Starting on Convex Surfaces</p> <ul style="list-style-type: none"> • Reduce entry feed by 50%. • Use lower rake geometry if insert chipping occurs.
	<p>Drilling Through a Cross Hole</p> <ul style="list-style-type: none"> • Reduce feed rate by 50% if necessary. • Use good coolant flow and monitor chip packing. • Use lower rake geometry if insert chipping occurs.
	<p>Chain Drilling</p> <ul style="list-style-type: none"> • Use good coolant flow. • Reduce feed rate by 50% for interrupted cut. • Use lower rake geometry if insert chipping occurs.

THE PROOF IS IN THE CHIPS

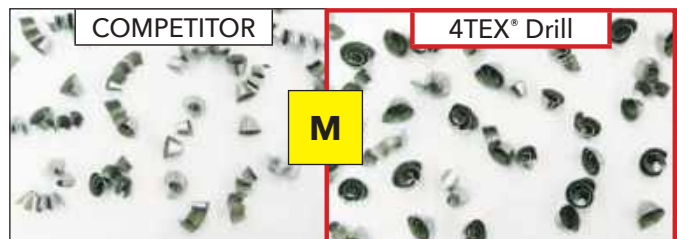
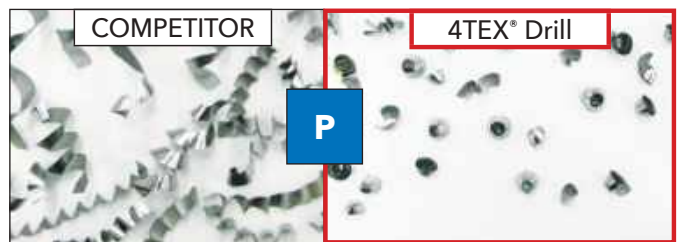



Product Nomenclature

4TEX Drill Holders

D4	03	1200	M	-	075	F
1	2	3*	4		5	6

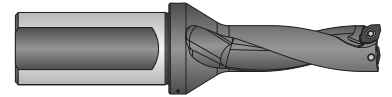

1. Length-to-Diameter-Ratio
D2 = 2xD
D3 = 3xD
D4 = 4xD

2. Series	
03 = 03 series	07 = 07 series
04 = 04 series	09 = 09 series
05 = 05 series	11 = 11 series
06 = 06 series	14 = 14 series

3. Diameter*
0750 = 0.0750"
1200 = 12 mm

4. Diameter Style
I = Imperial
M = Metric

5. Shank Diameter	
Imperial	Metric
075 = 0.750"	20 = 20 mm
100 = 1.000"	25 = 25 mm
125 = 1.250"	32 = 32 mm
150 = 1.500"	40 = 40 mm

6. Shank Style
F = Imperial flanged shank
FM = Metric flanged shank

***Ordering Nonstocked Diameters:**
 Nonstocked diameters are available upon request. Please refer to price list for applicable process fees.

Ordering example:
 Inch: 03 Series (Ø 0.480") = D2030480I-075F
 Metric: 03 Series (12.65 mm) = D2031265M-20FM

Reference Key

Symbol	Attribute
D₁	Drill diameter
D₂	Shank diameter
D₃	Flange diameter
L₁	Assembled overall length
L₂	Drill depth
L₃	Reference length

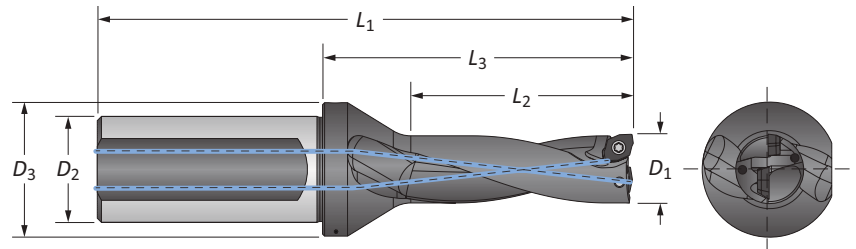

A

DRILLING

B

BORING

C

REAMING

D

BURNISHING

E

THREADING

X

SPECIALS

**4TEX® Drill Holders | Imperial Shank | Metric Shank**

03 Series | Diameter Range: 0.472" - 0.512" (12.00 mm - 13.00 mm)*

*See the 4TEX drill catalog (A55-4TX) for all diameters available.

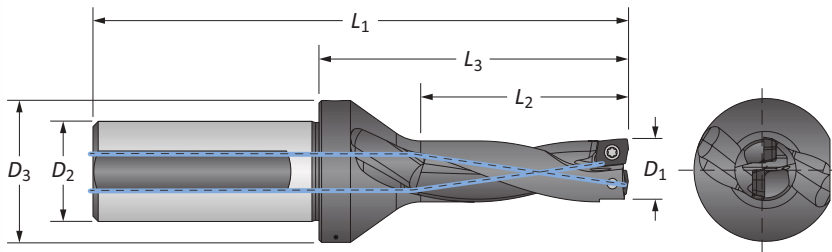
**Imperial Shank**

Length	Fractional Equivalent	D ₁		Body			Shank		Max Offset	Part No.
		in	mm	L ₂	L ₃	L ₁	D ₂	D ₃		
2xD	–	0.472	12.00	0.945	1.787	3.480	0.750	1.063	0.020	D2031200M-075F
	–	0.512	13.00	1.024	1.866	3.559	0.750	1.063	0.012	D2031300M-075F
3xD	–	0.472	12.00	1.417	2.260	3.953	0.750	1.063	0.020	D3031200M-075F
	–	0.512	13.00	1.535	2.378	4.071	0.750	1.063	0.012	D3031300M-075F
4xD	–	0.472	12.00	1.890	2.732	4.425	0.750	1.063	0.020	D4031200M-075F
	–	0.512	13.00	2.047	2.890	4.583	0.750	1.063	0.012	D4031300M-075F

Metric Shank

Length	Fractional Equivalent	D ₁		Body			Shank		Max Offset	Part No.
		in	mm	L ₂	L ₃	L ₁	D ₂	D ₃		
2xD	–	0.472	12.00	24.00	45.40	88.40	20.00	27.00	0.50	D2031200M-20FM
	–	0.512	13.00	26.00	47.40	90.40	20.00	27.00	0.30	D2031300M-20FM
3xD	–	0.472	12.00	36.00	57.40	100.40	20.00	27.00	0.50	D3031200M-20FM
	–	0.512	13.00	39.00	60.40	103.40	20.00	27.00	0.30	D3031300M-20FM
4xD	–	0.472	12.00	48.00	69.40	112.40	20.00	27.00	0.50	D4031200M-20FM
	–	0.512	13.00	52.00	73.40	116.40	20.00	27.00	0.30	D4031300M-20FM

IC Inserts

ISO Material	Style	Part No.	Insert Screw	Torx® Driver	Admissible Tightening Torque
P	Center	4T-030203C-P	7241-T6-1	8T-6	4.4 in-lbs (0.5 N-m)
	Periphery	4T-030203P-P			
S M	Center	4T-030203C-M			
	Periphery	4T-030203P-M			
H	Center	4T-030203C-H			
	Periphery	4T-030203P-H			
K	Center	4T-030203C-K			
	Periphery	4T-030203P-K			
N	Center	4T-030203C-N			
	Periphery	4T-030203P-N			

Expected Hole Tolerances

Length	in	mm
2xD	-0.004 / +0.008	-0.10 / +0.20
3xD	-0.004 / +0.008	-0.10 / +0.20
4xD	-0.004 / +0.010	-0.10 / +0.25

A91: 66

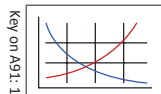

A91: 59 - 61



A91: 58

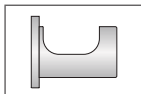

Key on A91: 1

i = Imperial (in)
m = Metric (mm)

IC inserts sold in quantities of 10.
 Insert screws sold in quantities of 10.



4TEX® Drill Holders | Imperial Shank | Metric Shank

04 Series | Diameter Range: 0.551" - 0.591" (14.00 mm - 15.00 mm)*

*See the 4TEX drill catalog (A55-4TX) for all diameters available.

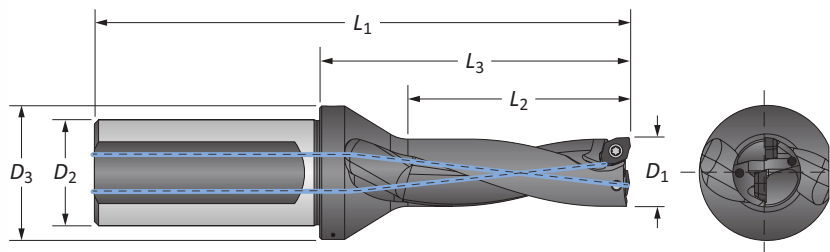

Imperial Shank

Length	Fractional Equivalent	D ₁		Body			Shank		Max Offset	Part No.
		in	mm	L ₂	L ₃	L ₁	D ₂	D ₃		
2xD	-	0.551	14.00	1.102	1.945	3.638	0.750	1.063	0.016	D2041400M-075F
	9/16	0.563	14.29	1.124	1.945	3.638	0.750	1.063	0.013	D2040562I-075F
	-	0.591	15.00	1.181	2.024	3.717	0.750	1.063	0.008	D2041500M-075F
3xD	-	0.551	14.00	1.654	2.496	4.189	0.750	1.063	0.016	D3041400M-075F
	9/16	0.563	14.29	1.686	2.496	4.189	0.750	1.063	0.013	D3040562I-075F
	-	0.591	15.00	1.772	2.614	4.307	0.750	1.063	0.008	D3041500M-075F
4xD	-	0.551	14.00	2.205	3.047	4.740	0.750	1.063	0.016	D4041400M-075F
	9/16	0.563	14.29	2.248	3.047	4.740	0.750	1.063	0.013	D4040562I-075F
	-	0.591	15.00	2.362	3.205	4.898	0.750	1.063	0.008	D4041500M-075F

Metric Shank

Length	Fractional Equivalent	D ₁		Body			Shank		Max Offset	Part No.
		in	mm	L ₂	L ₃	L ₁	D ₂	D ₃		
2xD	-	0.551	14.00	28.00	49.40	92.40	20.00	27.00	0.40	D2041400M-20FM
	9/16	0.563	14.29	28.55	49.40	92.40	20.00	27.00	0.30	D2040562I-20FM
	-	0.591	15.00	30.00	51.40	94.40	20.00	27.00	0.20	D2041500M-20FM
3xD	-	0.551	14.00	42.00	63.40	106.40	20.00	27.00	0.40	D3041400M-20FM
	9/16	0.563	14.29	42.82	63.40	106.40	20.00	27.00	0.30	D3040562I-20FM
	-	0.591	15.00	45.00	66.40	109.40	20.00	27.00	0.20	D3041500M-20FM
4xD	-	0.551	14.00	56.00	77.40	120.40	20.00	27.00	0.40	D4041400M-20FM
	9/16	0.563	14.29	57.10	77.40	120.40	20.00	27.00	0.30	D4040562I-20FM
	-	0.591	15.00	60.00	81.40	124.40	20.00	27.00	0.20	D4041500M-20FM

IC Inserts

ISO Material	Part No.	Insert Screw	Torx® Driver	Admissible Tightening Torque
P	4T-040203-P	7241-T6-1	8T-6	4.4 in-lbs (0.5 N-m)
S	4T-040203-M			
H	4T-040203-H			
K	4T-040203-K			
N	4T-040203-N			

Expected Hole Tolerances

Length	in	mm
2xD	-0.004 / +0.008	-0.10 / +0.20
3xD	-0.004 / +0.008	-0.10 / +0.20
4xD	-0.004 / +0.010	-0.10 / +0.25

A91: 66

A91: 59 - 61

A91: 58

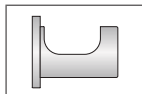
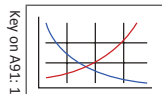

ⓘ = Imperial (in)
Ⓜ = Metric (mm)

IC inserts sold in quantities of 10.
Insert screws sold in quantities of 10.

**4TEX® Drill Holders | Imperial Shank**

05 Series | Diameter Range: 0.625" - 0.709" (15.88 mm - 18.00 mm)*

*See the 4TEX drill catalog (A55-4TX) for all diameters available.

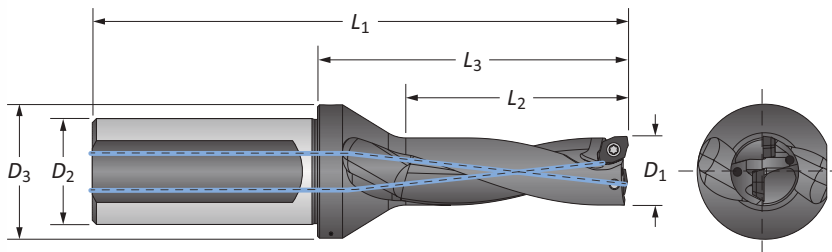
**Imperial Shank**

Length	Fractional Equivalent	D_1		Body			Shank		Max Offset	Part No.
		in	mm	L_2	L_3	L_1	D_2	D_3		
2xD	5/8	0.625	15.88	1.250	2.146	4.272	1.000	1.260	0.029	D2050625I-100F
	-	0.630	16.00	1.260	2.185	4.311	1.000	1.260	0.028	D2051600M-100F
	-	0.669	17.00	1.339	2.264	4.390	1.000	1.260	0.016	D2051700M-100F
	11/16	0.687	17.46	1.374	2.264	4.390	1.000	1.260	0.012	D2050687I-100F
	-	0.709	18.00	1.417	2.343	4.469	1.000	1.260	0.008	D2051800M-100F
3xD	5/8	0.625	15.88	1.875	2.756	4.882	1.000	1.260	0.029	D3050625I-100F
	-	0.630	16.00	1.890	2.815	4.941	1.000	1.260	0.028	D3051600M-100F
	-	0.669	17.00	2.008	2.933	5.059	1.000	1.260	0.016	D3051700M-100F
	11/16	0.687	17.46	2.061	2.933	5.059	1.000	1.260	0.012	D3050687I-100F
	-	0.709	18.00	2.126	3.051	5.177	1.000	1.260	0.008	D3051800M-100F
4xD	5/8	0.625	15.88	2.500	3.366	5.492	1.000	1.260	0.029	D4050625I-100F
	-	0.630	16.00	2.520	3.445	5.571	1.000	1.260	0.028	D4051600M-100F
	-	0.669	17.00	2.677	3.602	5.728	1.000	1.260	0.016	D4051700M-100F
	11/16	0.687	17.46	2.748	3.602	5.728	1.000	1.260	0.012	D4050687I-100F
	-	0.709	18.00	2.835	3.760	5.886	1.000	1.260	0.008	D4051800M-100F

IC Inserts

ISO Material	Part No.	Insert Screw	Torx® Driver	Admissible Tightening Torque
P	4T-05T203-P	7243-T6-1	8T-6	4.4 in-lbs (0.5 N-m)
S	4T-05T203-M			
H	4T-05T203-H			
K	4T-05T203-K			
N	4T-05T203-N			

Expected Hole Tolerances

Length	in	mm
2xD	-0.004 / +0.008	-0.10 / +0.20
3xD	-0.004 / +0.008	-0.10 / +0.20
4xD	-0.004 / +0.010	-0.10 / +0.25

A91: 66

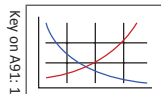

A91: 59 - 61



A91: 58

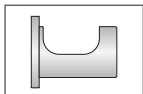

Key on A91: 1

i = Imperial (in)
m = Metric (mm)

IC inserts sold in quantities of 10.
 Insert screws sold in quantities of 10.



4TEX® Drill Holders | Metric Shank

05 Series | Diameter Range: 0.625" - 0.709" (15.88 mm - 18.00 mm)*

*See the 4TEX drill catalog (A55-4TX) for all diameters available.

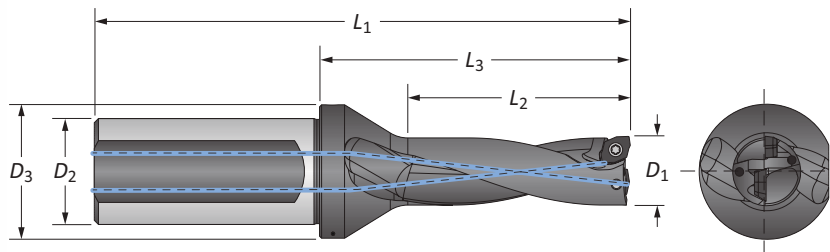

Metric Shank

Length	Fractional Equivalent	D ₁		Body			Shank		Max Offset	Part No.
		in	mm	L ₂	L ₃	L ₁	D ₂	D ₃		
2xD	5/8	0.625	15.88	31.75	54.50	108.50	25.00	32.00	0.70	D2050625I-25FM
	-	0.630	16.00	32.00	55.50	109.50	25.00	32.00	0.70	D2051600M-25FM
	-	0.669	17.00	34.00	57.50	111.50	25.00	32.00	0.40	D2051700M-25FM
	11/16	0.687	17.46	34.90	57.50	111.50	25.00	32.00	0.30	D2050687I-25FM
	-	0.709	18.00	36.00	59.50	113.50	25.00	32.00	0.20	D2051800M-25FM
3xD	5/8	0.625	15.88	47.63	70.00	124.00	25.00	32.00	0.70	D3050625I-25FM
	-	0.630	16.00	48.00	71.50	125.50	25.00	32.00	0.70	D3051600M-25FM
	-	0.669	17.00	51.00	74.50	128.50	25.00	32.00	0.40	D3051700M-25FM
	11/16	0.687	17.46	52.35	74.50	128.50	25.00	32.00	0.30	D3050687I-25FM
	-	0.709	18.00	54.00	77.50	131.50	25.00	32.00	0.20	D3051800M-25FM
4xD	5/8	0.625	15.88	63.50	85.50	139.50	25.00	32.00	0.70	D4050625I-25FM
	-	0.630	16.00	64.00	87.50	141.50	25.00	32.00	0.70	D4051600M-25FM
	-	0.669	17.00	68.00	91.50	145.50	25.00	32.00	0.40	D4051700M-25FM
	11/16	0.687	17.46	69.80	91.50	145.50	25.00	32.00	0.30	D4050687I-25FM
	-	0.709	18.00	72.00	95.50	149.50	25.00	32.00	0.20	D4051800M-25FM

IC Inserts

ISO Material	Part No.	Insert Screw	Torx® Driver	Admissible Tightening Torque
P	4T-05T203-P	7243-T6-1	8T-6	4.4 in-lbs (0.5 N-m)
S M	4T-05T203-M			
H	4T-05T203-H			
K	4T-05T203-K			
N	4T-05T203-N			

Expected Hole Tolerances

Length	in	mm
2xD	-0.004 / +0.008	-0.10 / +0.20
3xD	-0.004 / +0.008	-0.10 / +0.20
4xD	-0.004 / +0.010	-0.10 / +0.25

A91: 66

A91: 59 - 61

A91: 58

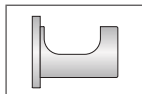
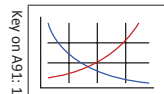

I = Imperial (in)
M = Metric (mm)

IC inserts sold in quantities of 10.
Insert screws sold in quantities of 10.

**4TEX® Drill Holders | Imperial Shank**

06 Series | Diameter Range: 0.748" - 0.827" (19.00 mm - 21.00 mm)*

*See the 4TEX drill catalog (A55-4TX) for all diameters available.

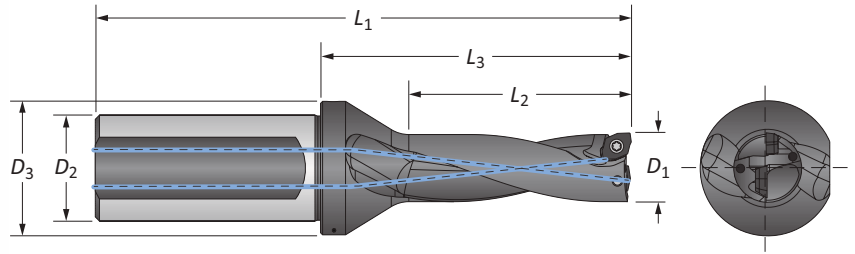
**Imperial Shank**

Length	Fractional Equivalent	D_1		Body			Shank		Max Offset	Part No.
		in	mm	L_2	L_3	L_1	D_2	D_3		
2xD	–	0.748	19.00	1.496	2.339	4.465	1.000	1.260	0.031	D2061900M-100F
	–	0.787	20.00	1.575	2.417	4.543	1.000	1.260	0.020	D2062000M-100F
	13/16	0.813	20.64	1.624	2.457	4.583	1.000	1.260	0.015	D2060812I-100F
	–	0.827	21.00	1.654	2.496	4.622	1.000	1.260	0.012	D2062100M-100F
3xD	–	0.748	19.00	2.244	3.087	5.213	1.000	1.260	0.031	D3061900M-100F
	–	0.787	20.00	2.362	3.205	5.331	1.000	1.260	0.020	D3062000M-100F
	13/16	0.813	20.64	2.436	3.264	5.390	1.000	1.260	0.015	D3060812I-100F
	–	0.827	21.00	2.480	3.323	5.449	1.000	1.260	0.012	D3062100M-100F
4xD	–	0.748	19.00	2.992	3.835	5.961	1.000	1.260	0.031	D4061900M-100F
	–	0.787	20.00	3.150	3.992	6.118	1.000	1.260	0.020	D4062000M-100F
	13/16	0.813	20.64	3.248	4.071	6.197	1.000	1.260	0.015	D4060812I-100F
	–	0.827	21.00	3.307	4.150	6.276	1.000	1.260	0.012	D4062100M-100F

IC Inserts

ISO Material	Part No.	Insert Screw	Torx® Driver	Admissible Tightening Torque
P	4T-06T204-P	72251-T7-1	8T-7	7.1 in-lbs (0.8 N-m)
S M	4T-06T204-M			
H	4T-06T204-H			
K	4T-06T204-K			
N	4T-06T204-N			

Expected Hole Tolerances

Length	in	mm
2xD	-0.004 / +0.008	-0.10 / +0.20
3xD	-0.004 / +0.008	-0.10 / +0.20
4xD	-0.004 / +0.010	-0.10 / +0.25

A91: 66

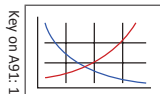

A91: 59 - 61



A91: 58

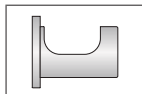

i = Imperial (in)
m = Metric (mm)

IC inserts sold in quantities of 10.
 Insert screws sold in quantities of 10.

4TEX® Drill Holders | Metric Shank

06 Series | Diameter Range: 0.748" - 0.827" (19.00 mm - 21.00 mm)*

*See the 4TEX drill catalog (A55-4TX) for all diameters available.

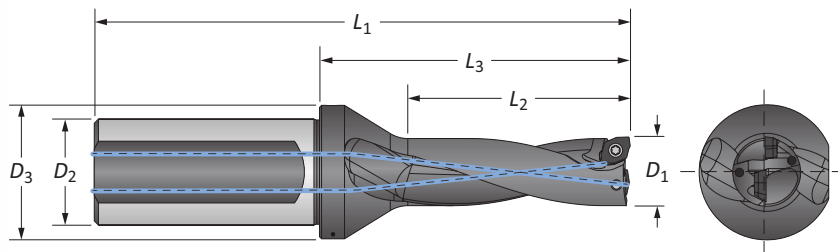

Metric Shank

Length	Fractional Equivalent	D ₁		Body			Shank		Max Offset	Part No.
		in	mm	L ₂	L ₃	L ₁	D ₂	D ₃		
2xD	-	0.748	19.00	38.00	59.40	113.40	25.00	32.00	0.80	D2061900M-25FM
	-	0.787	20.00	40.00	61.40	115.40	25.00	32.00	0.50	D2062000M-25FM
	13/16	0.813	20.64	41.25	62.40	116.40	25.00	32.00	0.40	D2060812I-25FM
	-	0.827	21.00	42.00	63.40	117.40	25.00	32.00	0.30	D2062100M-25FM
3xD	-	0.748	19.00	57.00	78.40	132.40	25.00	32.00	0.80	D3061900M-25FM
	-	0.787	20.00	60.00	81.40	135.40	25.00	32.00	0.50	D3062000M-25FM
	13/16	0.813	20.64	61.87	82.90	136.90	25.00	32.00	0.40	D3060812I-25FM
	-	0.827	21.00	63.00	84.40	138.40	25.00	32.00	0.30	D3062100M-25FM
4xD	-	0.748	19.00	76.00	97.40	151.40	25.00	32.00	0.80	D4061900M-25FM
	-	0.787	20.00	80.00	101.40	155.40	25.00	32.00	0.50	D4062000M-25FM
	13/16	0.813	20.64	82.49	103.40	157.40	25.00	32.00	0.40	D4060812I-25FM
	-	0.827	21.00	84.00	105.40	159.40	25.00	32.00	0.30	D4062100M-25FM

IC Inserts

ISO Material	Part No.	Insert Screw	Torx® Driver	Admissible Tightening Torque
P	4T-06T204-P	72251-T7-1	8T-7	7.1 in-lbs (0.8 N-m)
S M	4T-06T204-M			
H	4T-06T204-H			
K	4T-06T204-K			
N	4T-06T204-N			

Expected Hole Tolerances

Length	in	mm
2xD	-0.004 / +0.008	-0.10 / +0.20
3xD	-0.004 / +0.008	-0.10 / +0.20
4xD	-0.004 / +0.010	-0.10 / +0.25

A91: 66

A91: 59 - 61

A91: 58

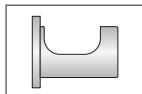
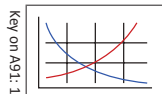

i = Imperial (in)
m = Metric (mm)

IC inserts sold in quantities of 10.
Insert screws sold in quantities of 10.

**4TEX® Drill Holders | Imperial Shank**

07 Series | Diameter Range: 0.866" - 1.024" (22.00 mm - 26.00 mm)*

*See the 4TEX drill catalog (A55-4TX) for all diameters available.

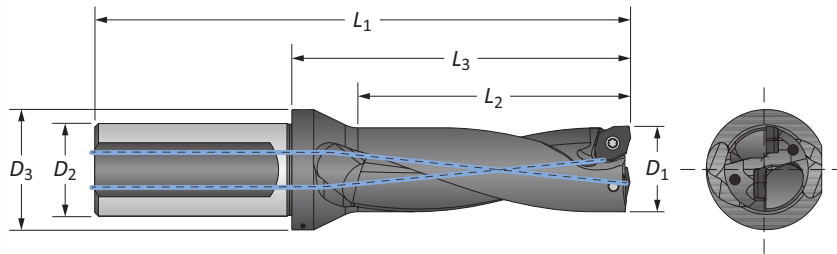
**Imperial Shank**

Length	Fractional Equivalent	D ₁		Body			Shank		Max Offset	Part No.
		in	mm	L ₂	L ₃	L ₁	D ₂	D ₃		
2xD	–	0.866	22.00	1.732	2.555	4.681	1.000	1.299	0.047	D2072200M-100F
	7/8	0.875	22.22	1.750	2.555	4.681	1.000	1.299	0.043	D2070875I-100F
	–	0.906	23.00	1.811	2.634	4.760	1.000	1.299	0.035	D2072300M-100F
	15/16	0.937	23.81	1.874	2.673	4.799	1.000	1.299	0.292	D2070937I-100F
	–	0.945	24.00	1.890	2.713	4.839	1.000	1.299	0.028	D2072400M-100F
	–	1.000	25.40	2.000	2.791	4.917	1.000	1.299	0.013	D2071000I-100F
3xD	–	1.024	26.00	2.047	2.870	4.996	1.000	1.299	0.008	D2072600M-100F
	–	0.866	22.00	2.598	3.421	5.547	1.000	1.299	0.047	D3072200M-100F
	7/8	0.875	22.22	2.625	3.421	5.547	1.000	1.299	0.043	D3070875I-100F
	–	0.906	23.00	2.717	3.539	5.665	1.000	1.299	0.035	D3072300M-100F
	15/16	0.937	23.81	2.811	3.598	5.724	1.000	1.299	0.292	D3070937I-100F
	–	0.945	24.00	2.835	3.657	5.783	1.000	1.299	0.028	D3072400M-100F
4xD	–	1.000	25.40	3.000	3.776	5.902	1.000	1.299	0.013	D3071000I-100F
	–	1.024	26.00	3.071	3.894	6.020	1.000	1.299	0.008	D3072600M-100F
	–	0.866	22.00	3.465	4.287	6.413	1.000	1.299	0.047	D4072200M-100F
	7/8	0.875	22.22	3.500	4.287	6.413	1.000	1.299	0.043	D4070875I-100F
	–	0.906	23.00	3.622	4.445	6.571	1.000	1.299	0.035	D4072300M-100F
	15/16	0.937	23.81	3.748	4.524	6.650	1.000	1.299	0.292	D4070937I-100F
4xD	–	0.945	24.00	3.780	4.602	6.728	1.000	1.299	0.028	D4072400M-100F
	–	1.000	25.40	4.000	4.760	6.886	1.000	1.299	0.013	D4071000I-100F
	–	1.024	26.00	4.094	4.917	7.043	1.000	1.299	0.008	D4072600M-100F

IC Inserts

ISO Material	Part No.	Insert Screw	Torx® Driver	Admissible Tightening Torque
P	4T-070305-P	72568-T8-1	8T-8	10.6 in-lbs (1.2 N-m)
S M	4T-070305-M			
H	4T-070305-H			
K	4T-070305-K			
N	4T-070305-N			

Expected Hole Tolerances

Length	in	mm
2xD	-0.004 / +0.008	-0.10 / +0.20
3xD	-0.004 / +0.008	-0.10 / +0.20
4xD	-0.004 / +0.010	-0.10 / +0.25

A91: 66

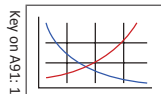

A91: 59 - 61



A91: 58

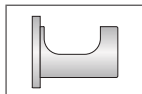

Key on A91: 1

ⓘ = Imperial (in)
 ⓘ = Metric (mm)

IC inserts sold in quantities of 10.
 Insert screws sold in quantities of 10.



4TEX® Drill Holders | Metric Shank

07 Series | Diameter Range: 0.866" - 1.024" (22.00 mm - 26.00 mm)*

*See the 4TEX drill catalog (A55-4TX) for all diameters available.

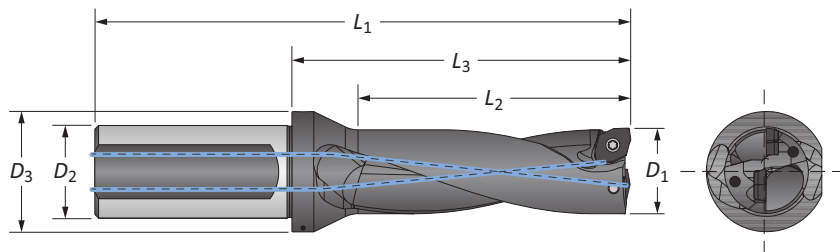

Metric Shank

Length	Fractional Equivalent	D ₁		Body			Shank		Max Offset	Part No.
		in	mm	L ₂	L ₃	L ₁	D ₂	D ₃		
2xD	-	0.866	22.00	44.00	64.90	118.90	25.00	33.00	1.20	D2072200M-25FM
	7/8	0.875	22.22	44.45	64.90	118.90	25.00	33.00	1.10	D2070875I-25FM
	-	0.906	23.00	46.00	66.90	120.90	25.00	33.00	0.90	D2072300M-25FM
	15/16	0.937	23.81	47.60	67.90	121.90	25.00	33.00	7.40	D2070937I-25FM
	-	0.945	24.00	48.00	68.90	122.90	25.00	33.00	0.70	D2072400M-25FM
	-	1.000	25.40	50.80	70.90	124.90	25.00	33.00	0.30	D2071000I-25FM
3xD	-	0.866	22.00	66.00	86.90	140.90	25.00	33.00	1.20	D3072200M-25FM
	7/8	0.875	22.22	66.68	86.90	140.90	25.00	33.00	1.10	D3070875I-25FM
	-	0.906	23.00	69.00	89.90	143.90	25.00	33.00	0.90	D3072300M-25FM
	15/16	0.937	23.81	71.40	91.40	145.40	25.00	33.00	7.40	D3070937I-25FM
	-	0.945	24.00	72.00	92.90	146.90	25.00	33.00	0.70	D3072400M-25FM
	-	1.000	25.40	76.20	95.90	149.90	25.00	33.00	0.30	D3071000I-25FM
4xD	-	0.866	22.00	88.00	109.00	163.00	25.00	33.00	1.20	D4072200M-25FM
	7/8	0.875	22.22	88.90	108.90	162.90	25.00	33.00	1.10	D4070875I-25FM
	-	0.906	23.00	92.00	113.00	167.00	25.00	33.00	0.90	D4072300M-25FM
	15/16	0.937	23.81	95.20	114.90	168.90	25.00	33.00	7.40	D4070937I-25FM
	-	0.945	24.00	96.00	117.00	171.00	25.00	33.00	0.70	D4072400M-25FM
	-	1.000	25.40	101.60	120.90	174.90	25.00	33.00	0.30	D4071000I-25FM
-	1.024	26.00	104.00	125.00	179.00	25.00	33.00	0.20	D4072600M-25FM	

IC Inserts

ISO Material	Part No.	Insert Screw	Torx® Driver	Admissible Tightening Torque
P	4T-070305-P	72568-T8-1	8T-8	10.6 in-lbs (1.2 N-m)
S M	4T-070305-M			
H	4T-070305-H			
K	4T-070305-K			
N	4T-070305-N			

Expected Hole Tolerances

Length	in	mm
2xD	-0.004 / +0.008	-0.10 / +0.20
3xD	-0.004 / +0.008	-0.10 / +0.20
4xD	-0.004 / +0.010	-0.10 / +0.25

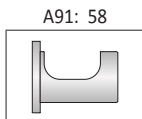
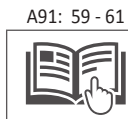
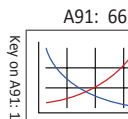

ⓘ = Imperial (in)
Ⓜ = Metric (mm)

IC inserts sold in quantities of 10.
Insert screws sold in quantities of 10.

**4TEX® Drill Holders | Imperial Shank**

09 Series | Diameter Range: 1.063" - 1.250" (27.00 mm - 31.75 mm)*

*See the 4TEX drill catalog (A55-4TX) for all diameters available.

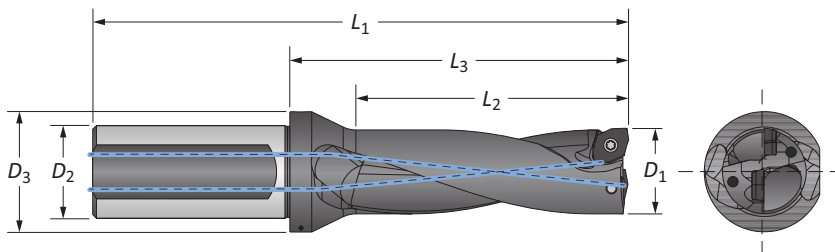
**Imperial Shank**

Length	Fractional Equivalent	D ₁		Body			Shank		Max Offset	Part No.
		in	mm	L ₂	L ₃	L ₁	D ₂	D ₃		
2xD	–	1.063	27.00	2.126	3.020	5.343	1.250	1.614	0.063	D2092700M-125F
	–	1.102	28.00	2.205	3.098	5.421	1.250	1.614	0.051	D2092800M-125F
	1-1/8	1.125	28.58	2.250	3.138	5.461	1.250	1.614	0.046	D2091125I-125F
	–	1.142	29.00	2.283	3.177	5.500	1.250	1.614	0.043	D2092900M-125F
	–	1.181	30.00	2.362	3.256	5.579	1.250	1.693	0.031	D2093000M-125F
	1-3/16	1.187	30.15	2.374	3.256	5.579	1.250	1.693	0.032	D2091187I-125F
	–	1.220	31.00	2.441	3.335	5.657	1.250	1.693	0.024	D2093100M-125F
1-1/4	1.250	31.75	2.500	3.374	5.697	1.250	1.693	0.019	D2091250I-125F	
3xD	–	1.063	27.00	3.189	4.083	6.406	1.250	1.614	0.063	D3092700M-125F
	–	1.102	28.00	3.307	4.201	6.524	1.250	1.614	0.051	D3092800M-125F
	1-1/8	1.125	28.58	3.375	4.260	6.583	1.250	1.614	0.046	D3091125I-125F
	–	1.142	29.00	3.425	4.319	6.642	1.250	1.614	0.043	D3092900M-125F
	–	1.181	30.00	3.543	4.437	6.760	1.250	1.693	0.031	D3093000M-125F
	1-3/16	1.187	30.15	3.561	4.437	6.760	1.250	1.693	0.032	D3091187I-125F
	–	1.220	31.00	3.661	4.555	6.878	1.250	1.693	0.024	D3093100M-125F
1-1/4	1.250	31.75	3.750	4.614	6.937	1.250	1.693	0.019	D3091250I-125F	
4xD	–	1.063	27.00	4.252	5.146	7.469	1.250	1.614	0.063	D4092700M-125F
	–	1.102	28.00	4.409	5.303	7.626	1.250	1.614	0.051	D4092800M-125F
	1-1/8	1.125	28.58	4.500	5.382	7.705	1.250	1.614	0.046	D4091125I-125F
	–	1.142	29.00	4.567	5.461	7.783	1.250	1.614	0.043	D4092900M-125F
	–	1.181	30.00	4.724	5.618	7.941	1.250	1.693	0.031	D4093000M-125F
	1-3/16	1.187	30.15	4.748	5.618	7.941	1.250	1.693	0.032	D4091187I-125F
	–	1.220	31.00	4.882	5.776	8.098	1.250	1.693	0.024	D4093100M-125F
1-1/4	1.250	31.75	5.000	5.854	8.177	1.250	1.693	0.019	D4091250I-125F	

IC Inserts

ISO Material	Part No.	Insert Screw	Torx® Driver	Admissible Tightening Torque
P	4T-09T306-P			17.7 in-lbs (2.0 N-m)
S	4T-09T306-M			
H	4T-09T306-H			
K	4T-09T306-K			
N	4T-09T306-N			

Expected Hole Tolerances

Length	in	mm
2xD	-0.006 / +0.010	-0.15 / +0.25
3xD	-0.006 / +0.010	-0.15 / +0.25
4xD	-0.006 / +0.012	-0.15 / +0.30

A91: 66

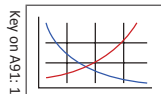

A91: 59 - 61



A91: 58

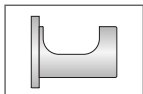

Key on A91: 1

ⓘ = Imperial (in)
 ⓘ = Metric (mm)

IC inserts sold in quantities of 10.
 Insert screws sold in quantities of 10.

4TEX® Drill Holders | Metric Shank

09 Series | Diameter Range: 1.063" - 1.250" (27.00 mm - 31.75 mm)*

*See the 4TEX drill catalog (A55-4TX) for all diameters available.

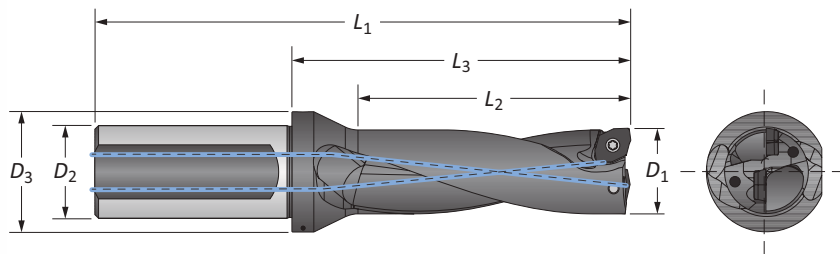

Metric Shank

Length	Fractional Equivalent	D ₁		Body			Shank		Max Offset	Part No.
		in	mm	L ₂	L ₃	L ₁	D ₂	D ₃		
2xD	-	1.063	27.00	54.00	76.70	135.70	32.00	41.00	1.60	D2092700M-32FM
	-	1.102	28.00	56.00	78.70	137.70	32.00	41.00	1.30	D2092800M-32FM
	1-1/8	1.125	28.58	57.15	79.70	138.70	32.00	41.00	1.20	D2091125I-32FM
	-	1.142	29.00	58.00	80.70	139.70	32.00	41.00	1.10	D2092900M-32FM
	-	1.181	30.00	60.00	82.70	141.70	32.00	43.00	0.80	D2093000M-32FM
	1-3/16	1.187	30.15	60.30	82.70	141.70	32.00	43.00	0.82	D2091187I-32FM
	-	1.220	31.00	62.00	84.70	143.70	32.00	43.00	0.60	D2093100M-32FM
3xD	1-1/4	1.250	31.75	63.50	85.70	144.70	32.00	43.00	0.50	D2091250I-32FM
	-	1.063	27.00	81.00	103.70	162.70	32.00	41.00	1.60	D3092700M-32FM
	-	1.102	28.00	84.00	106.70	165.70	32.00	41.00	1.30	D3092800M-32FM
	1-1/8	1.125	28.58	85.73	108.20	167.20	32.00	41.00	1.20	D3091125I-32FM
	-	1.142	29.00	87.00	109.70	168.70	32.00	41.00	1.10	D3092900M-32FM
	-	1.181	30.00	90.00	112.70	171.70	32.00	43.00	0.80	D3093000M-32FM
	1-3/16	1.187	30.15	90.45	112.70	171.70	32.00	43.00	0.82	D3091187I-32FM
4xD	-	1.220	31.00	93.00	115.70	174.70	32.00	43.00	0.60	D3093100M-32FM
	1-1/4	1.250	31.75	95.25	117.20	176.20	32.00	43.00	0.50	D3091250I-32FM
	-	1.063	27.00	108.00	130.70	189.70	32.00	41.00	1.60	D4092700M-32FM
	-	1.102	28.00	112.00	134.70	193.70	32.00	41.00	1.30	D4092800M-32FM
	1-1/8	1.125	28.58	114.30	136.70	195.70	32.00	41.00	1.20	D4091125I-32FM
	-	1.142	29.00	116.00	138.70	197.70	32.00	41.00	1.10	D4092900M-32FM
	-	1.181	30.00	120.00	142.70	201.70	32.00	43.00	0.80	D4093000M-32FM
4xD	1-3/16	1.187	30.15	120.60	142.70	201.70	32.00	43.00	0.82	D4091187I-32FM
	-	1.220	31.00	124.00	146.70	205.70	32.00	43.00	0.60	D4093100M-32FM
	1-1/4	1.250	31.75	127.00	148.70	207.70	32.00	43.00	0.50	D4091250I-32FM

IC Inserts

ISO Material	Part No.	Insert Screw	Torx® Driver	Admissible Tightening Torque
P	4T-09T306-P	738-T10-1	8T-10	17.7 in-lbs (2.0 N-m)
S M	4T-09T306-M			
H	4T-09T306-H			
K	4T-09T306-K			
N	4T-09T306-N			

Expected Hole Tolerances

Length	in	mm
2xD	-0.006 / +0.010	-0.15 / +0.25
3xD	-0.006 / +0.010	-0.15 / +0.25
4xD	-0.006 / +0.012	-0.15 / +0.30

A91: 66

A91: 59 - 61

A91: 58

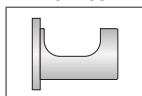
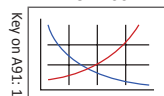

ⓘ = Imperial (in)
Ⓜ = Metric (mm)

IC inserts sold in quantities of 10.
Insert screws sold in quantities of 10.

**4TEX® Drill Holders | Imperial Shank**

11 Series | Diameter Range: 1.260" - 1.500" (32.00 mm - 38.10 mm)*

*See the 4TEX drill catalog (A55-4TX) for all diameters available.

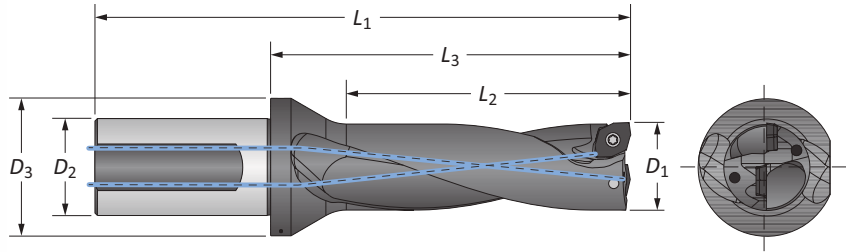
**Imperial Shank**

Length	Fractional Equivalent	D_1		Body			Shank		Max Offset	Part No.
		in	mm	L_2	L_3	L_1	D_2	D_3		
2xD	-	1.260	32.00	2.520	3.953	6.669	1.500	2.126	0.087	D2113200M-150F
	-	1.299	33.00	2.598	4.031	6.748	1.500	2.126	0.075	D2113300M-150F
	1-5/16	1.312	33.32	2.624	4.031	6.748	1.500	2.126	0.073	D2113121-150F
	-	1.339	34.00	2.677	4.110	6.827	1.500	2.126	0.067	D2113400M-150F
	1-3/8	1.375	34.92	2.750	4.110	6.827	1.500	2.126	0.056	D2111375I-150F
1-1/2	1.500	38.10	3.000	4.425	7.142	1.500	2.126	0.027	D2111500I-150F	
3xD	-	1.260	32.00	3.780	5.213	7.929	1.500	2.126	0.087	D3113200M-150F
	-	1.299	33.00	3.898	5.331	8.047	1.500	2.126	0.075	D3113300M-150F
	1-5/16	1.312	33.32	3.936	5.331	8.047	1.500	2.126	0.073	D3111312I-150F
	-	1.339	34.00	4.016	5.449	8.165	1.500	2.126	0.067	D3113400M-150F
	1-3/8	1.375	34.92	4.125	5.449	8.165	1.500	2.126	0.056	D3111375I-150F
1-1/2	1.500	38.10	4.500	5.921	8.638	1.500	2.126	0.027	D3111500I-150F	
4xD	-	1.260	32.00	5.039	6.079	8.795	1.500	2.126	0.087	D4113200M-150F
	-	1.299	33.00	5.197	6.236	8.953	1.500	2.126	0.075	D4113300M-150F
	1-5/16	1.312	33.32	5.248	6.236	8.953	1.500	2.126	0.073	D4111312I-150F
	-	1.339	34.00	5.354	6.394	9.110	1.500	2.126	0.067	D4113400M-150F
	1-3/8	1.375	34.92	5.500	6.394	9.110	1.500	2.126	0.056	D4111375I-150F
1-1/2	1.500	38.10	6.000	7.024	9.740	1.500	2.126	0.027	D4111500I-150F	

IC Inserts

ISO Material	Part No.	Insert Screw	Torx® Driver	Admissible Tightening Torque
P	4T-11T306-P			30.9 in-lbs (3.5 N-m)
S	4T-11T306-M			
H	4T-11T306-H			
K	4T-11T306-K			
N	4T-11T306-N			

Expected Hole Tolerances

Length	in	mm
2xD	-0.006 / +0.010	-0.15 / +0.25
3xD	-0.006 / +0.010	-0.15 / +0.25
4xD	-0.006 / +0.012	-0.15 / +0.30

A91: 66

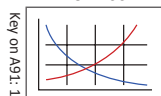

A91: 59 - 61



A91: 58

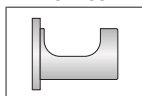

i = Imperial (in)
m = Metric (mm)

IC inserts sold in quantities of 10.
 Insert screws sold in quantities of 10.

4TEX® Drill Holders | Metric Shank

11 Series | Diameter Range: 1.260" - 1.500" (32.00 mm - 38.10 mm)*

*See the 4TEX drill catalog (A55-4TX) for all diameters available.

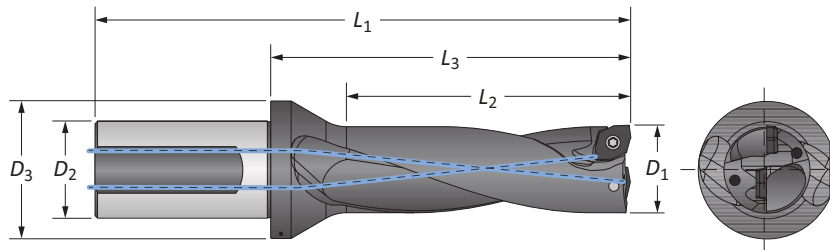

Metric Shank

Length	Fractional Equivalent	D ₁		Body			Shank		Max Offset	Part No.
		in	mm	L ₂	L ₃	L ₁	D ₂	D ₃		
2xD	-	1.260	32.00	64.00	100.40	169.40	40.00	54.00	2.20	D2113200M-40FM
	-	1.299	33.00	66.00	102.40	171.40	40.00	54.00	1.90	D2113300M-40FM
	1-5/16	1.312	33.32	66.65	102.40	171.40	40.00	54.00	1.84	D2111312I-40FM
	-	1.339	34.00	68.00	104.40	173.40	40.00	54.00	1.70	D2113400M-40FM
	1-3/8	1.375	34.92	69.85	104.40	173.40	40.00	54.00	1.42	D2111375I-40FM
1-1/2	1.500	38.10	76.20	112.40	181.40	40.00	54.00	0.69	D2111500I-40FM	
3xD	-	1.260	32.00	96.00	132.40	201.40	40.00	54.00	2.20	D3113200M-40FM
	-	1.299	33.00	99.00	135.40	204.40	40.00	54.00	1.90	D3113300M-40FM
	1-5/16	1.312	33.32	99.97	135.40	204.40	40.00	54.00	1.84	D3111312I-40FM
	-	1.339	34.00	102.00	138.40	207.40	40.00	54.00	1.70	D3113400M-40FM
	1-3/8	1.375	34.92	104.78	138.40	207.40	40.00	54.00	1.42	D3111375I-40FM
1-1/2	1.500	38.10	114.30	150.40	219.40	40.00	54.00	0.69	D3111500I-40FM	
4xD	-	1.260	32.00	128.00	154.40	223.40	40.00	54.00	2.20	D4113200M-40FM
	-	1.299	33.00	132.00	158.40	227.40	40.00	54.00	1.90	D4113300M-40FM
	1-5/16	1.312	33.32	133.30	158.40	227.40	40.00	54.00	1.84	D4111312I-40FM
	-	1.339	34.00	136.00	162.40	231.40	40.00	54.00	1.70	D4113400M-40FM
	1-3/8	1.375	34.92	139.70	162.40	231.40	40.00	54.00	1.42	D4111375I-40FM
1-1/2	1.500	38.10	152.40	178.40	247.40	40.00	54.00	0.69	D4111500I-40FM	

IC Inserts

ISO Material	Part No.	Insert Screw	Torx® Driver	Admissible Tightening Torque
P	4T-11T306-P	7488-T15-1	8T-15	30.9 in-lbs (3.5 N-m)
S M	4T-11T306-M			
H	4T-11T306-H			
K	4T-11T306-K			
N	4T-11T306-N			

Expected Hole Tolerances

Length	in	mm
2xD	-0.006 / +0.010	-0.15 / +0.25
3xD	-0.006 / +0.010	-0.15 / +0.25
4xD	-0.006 / +0.012	-0.15 / +0.30

A91: 66

A91: 59 - 61

A91: 58

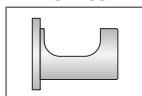
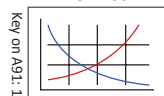

ⓘ = Imperial (in)
Ⓜ = Metric (mm)

IC inserts sold in quantities of 10.
Insert screws sold in quantities of 10.

**4TEX® Drill Holders | Imperial Shank**

14 Series | Diameter Range: 1.535" - 1.562" (39.00 mm - 39.67 mm)*

*See the 4TEX drill catalog (A55-4TX) for all diameters available.

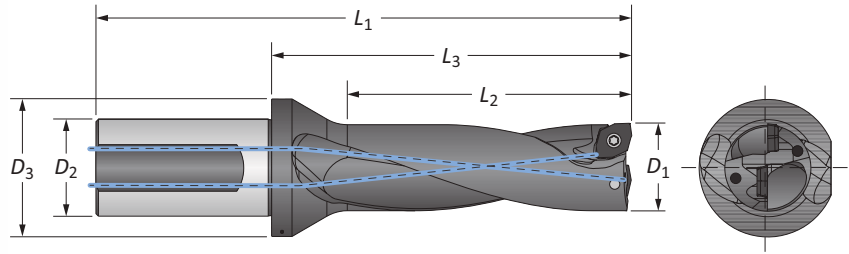
**Imperial Shank**

Length	Fractional Equivalent	D ₁		Body			Shank		Max Offset	Part No.
		in	mm	L ₂	L ₃	L ₁	D ₂	D ₃		
2xD	–	1.535	39.00	3.071	4.346	7.063	1.500	2.126	0.110	D2143900M-150F
	1-9/16	1.562	39.67	3.124	4.346	7.063	1.500	2.126	0.103	D2141562I-150F
3xD	–	1.535	39.00	4.606	5.882	8.598	1.500	2.126	0.110	D3143900M-150F
	1-9/16	1.562	39.67	4.686	5.882	8.598	1.500	2.126	0.103	D3141562I-150F
4xD	–	1.535	39.00	6.142	7.417	10.134	1.500	2.126	0.110	D4143900M-150F
	1-9/16	1.562	39.67	6.248	7.417	10.134	1.500	2.126	0.103	D4141562I-150F

IC Inserts

ISO Material	Part No.	Insert Screw	Torx® Driver	Admissible Tightening Torque
P	4T-140408-P			39.8 in-lbs (4.5 N-m)
S M	4T-140408-M			
H	4T-140408-H			
K	4T-140408-K			
N	4T-140408-N			

Expected Hole Tolerances

Length	in	mm
2xD	-0.008 / +0.012	-0.20 / +0.30
3xD	-0.008 / +0.012	-0.20 / +0.30
4xD	-0.008 / +0.014	-0.20 / +0.35

A91: 66

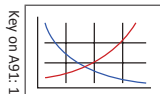

A91: 59 - 61



A91: 58

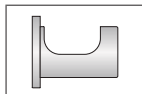

i = Imperial (in)
m = Metric (mm)

IC inserts sold in quantities of 10.
 Insert screws sold in quantities of 10.



4TEX® Drill Holders | Metric Shank

14 Series | Diameter Range: 1.535" - 1.562" (39.00 mm - 39.67 mm)*

*See the 4TEX drill catalog (A55-4TX) for all diameters available.

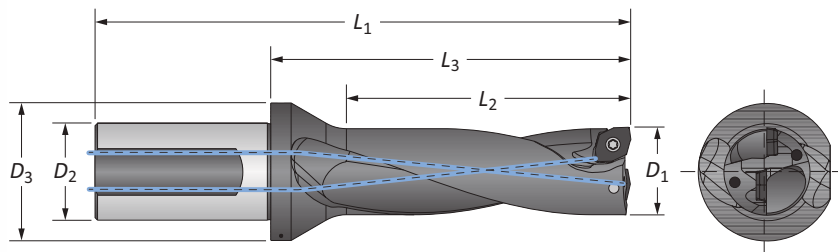

Metric Shank

Length	Fractional Equivalent	D ₁		Body			Shank		Max Offset	Part No.
		in	mm	L ₂	L ₃	L ₁	D ₂	D ₃		
2xD	-	1.535	39.00	78.00	110.40	179.40	40.00	54.00	2.80	D2143900M-40FM
	1-9/16	1.562	39.67	79.40	110.40	179.40	40.00	54.00	2.61	D2141562I-40FM
3xD	-	1.535	39.00	117.00	149.40	218.40	40.00	54.00	2.80	D3143900M-40FM
	1-9/16	1.562	39.67	119.02	149.40	218.40	40.00	54.00	2.61	D3141562I-40FM
4xD	-	1.535	39.00	156.00	188.40	257.40	40.00	54.00	2.80	D4143900M-40FM
	1-9/16	1.562	39.67	158.70	188.40	257.40	40.00	54.00	2.61	D4141562I-40FM

IC Inserts

ISO Material	Part No.	Insert Screw	Torx® Driver	Admissible Tightening Torque
P	4T-140408-P	7595-T20-1	8T-20	39.8 in-lbs (4.5 N-m)
S M	4T-140408-M			
H	4T-140408-H			
K	4T-140408-K			
N	4T-140408-N			

Expected Hole Tolerances

Length	in	mm
2xD	-0.008 / +0.012	-0.20 / +0.30
3xD	-0.008 / +0.012	-0.20 / +0.30
4xD	-0.008 / +0.014	-0.20 / +0.35

A91: 66 A91: 59 - 61 A91: 58

I = Imperial (in)
M = Metric (mm)
IC inserts sold in quantities of 10.
Insert screws sold in quantities of 10.



A
DRILLING
B
BORING
C
REAMING
D
BURNISHING
E
THREADING
X
SPECIALS

Eccentric Sleeves

For Cutting Diameter / Center Height Adjustment

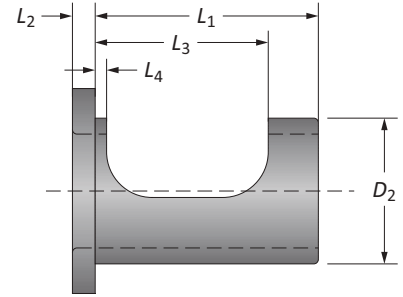
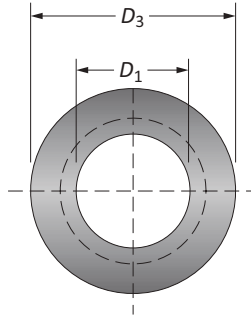

Sleeve Dimensions								Adjustment Range	
D_1	D_2	D_3	L_2	L_3	L_4	L_1	Part No.	Diameter*	Center Height
0.750	1.000	1.614	0.157	1.593	0.118	1.837	SLEEVE-075F	-0.008 to +0.016	-0.006 to +0.008
1.000	1.250	1.929	0.236	1.593	0.098	1.995	SLEEVE-100F	-0.008 to +0.016	-0.006 to +0.008
1.250	1.500	2.283	0.236	1.693	0.098	2.087	SLEEVE-125F	-0.008 to +0.016	-0.006 to +0.008
1.500	2.000	2.913	0.236	1.929	0.118	2.481	SLEEVE-150F	-0.008 to +0.024	-0.008 to +0.012
<hr/>									
25.00	32.00	49.00	6.00	39.00	2.50	54.00	SLEEVE-25FM	-0.20 to +0.40	-0.15 to +0.20
32.00	40.00	58.00	6.00	43.00	2.50	59.00	SLEEVE-32FM	-0.20 to +0.40	-0.15 to +0.20
40.00	50.00	74.00	6.00	49.00	3.00	69.00	SLEEVE-40FM	-0.20 to +0.40	-0.20 to +0.30

*Diameter adjustment range refers to the cutting diameter.

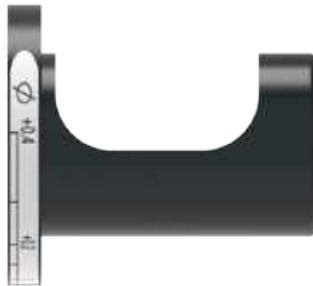

Milling Applications
Peripheral Adjustment Position



Lathe Applications
Front Adjustment Position

i = Imperial (in)
m = Metric (mm)



Diameter Adjustment

Milling and Lathe Applications



For Milling Applications

1. Assemble the 4TEX drill, eccentric sleeve, and tool holder. Do not tighten the tool holder set screws.
2. Using the peripheral marks for milling machines, align the reference indentation on the holder with the 0 (zero) mark on the eccentric sleeve to have no offset.
3. Rotate the sleeve in the (+) or (-) direction to increase or decrease the nominal diameter.
4. Once the drill has arrived at the desired diameter, firmly tighten the top set screw first and then tighten the bottom set screw.

NOTICE: Eccentric sleeves are to be used with side-locking tool holders only. Damage may result with other styles of tool holders.

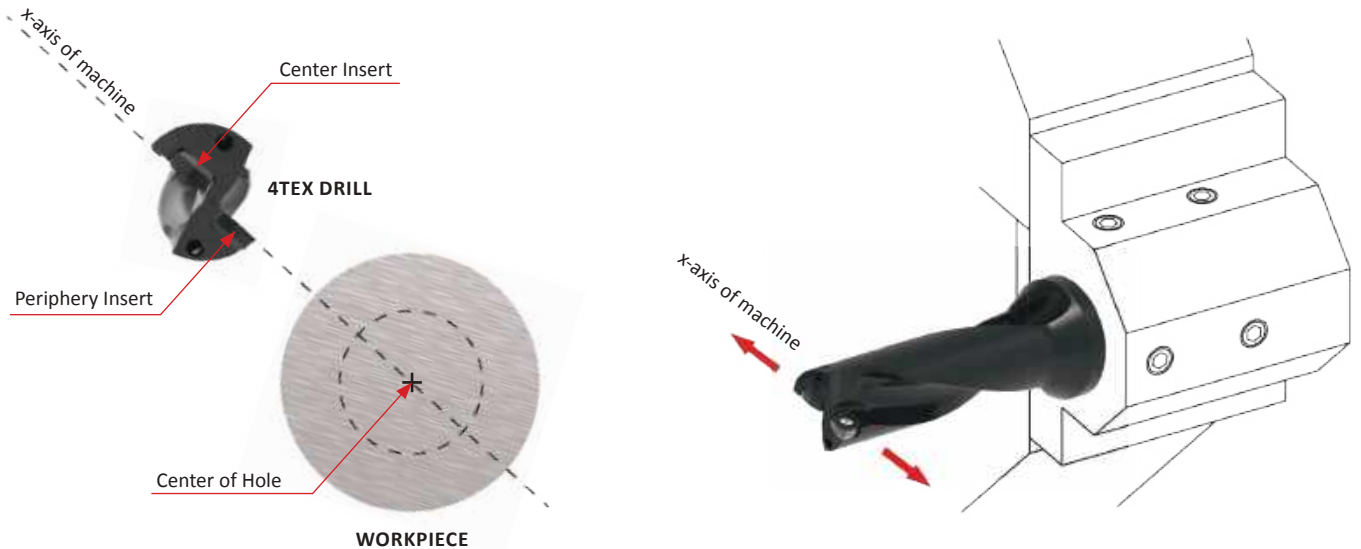

For Lathe Applications

1. Assemble the 4TEX drill into the lathe turret with the top face of the inserts parallel to the x-axis of the machine. This will allow for the diameter offsets to be made using the lathe's x-axis.
2. To increase the nominal diameter, offset the x-axis so the periphery insert moves away from the center of the hole.
3. To decrease the nominal diameter, offset the x-axis so the periphery insert moves toward the center of the hole.

NOTE: Eccentric sleeve is not required when adjusting the diameter of the hole on a lathe.



Center Height Alignment

Proper Center Line Position

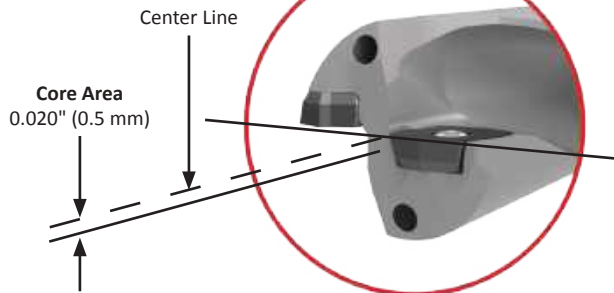
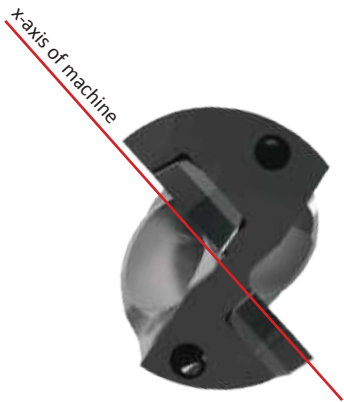

A
DRILLING

B
BORING

C
REAMING

D
URNISHING

E
HREADING

X
PECIALS

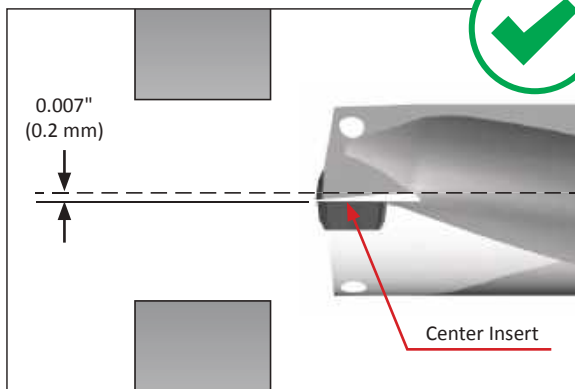

Proper Center Height Alignment

- The correct center height alignment will position the center insert 0.007" (0.2 mm) below the center line.

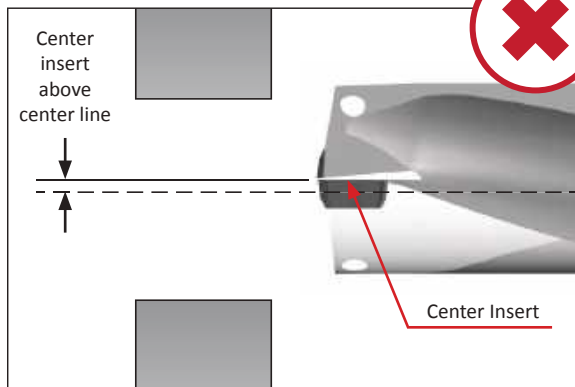
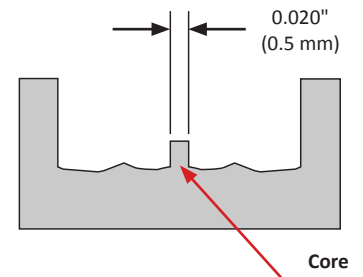

Center Insert Above the Center Line

- This will cause fracturing of the center insert.
- Requires center height adjustment.

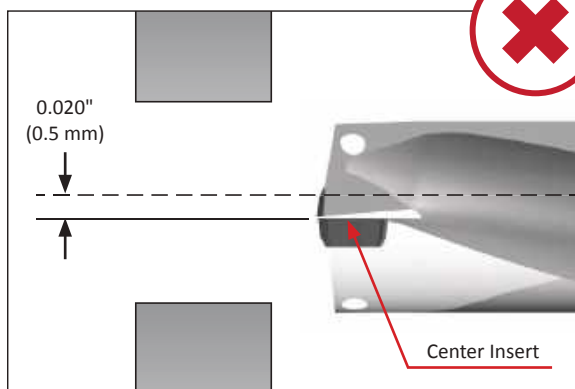
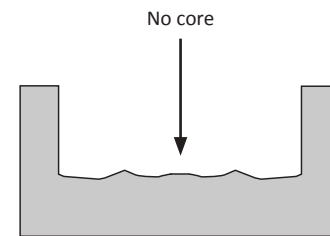

Center Insert Too Far Below Center Line

- This will cause the drill to interfere with the drilled hole.
- This will impede chip evacuation on the periphery insert.
- Requires center height adjustment.

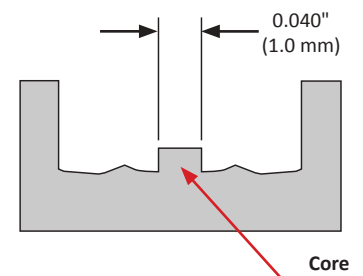

Center Height Alignment

How to Correct Issues



Method 1: Adjustment with X-Axis

1. Rotate the drill body so the position of the center line of the inserts is perpendicular to the lathe's x-axis.
2. Use the x-axis to offset the position of the center line in a (+) or (-) direction to increase or decrease the center core diameter at the bottom of the hole.

NOTE: This method does not allow diameter adjustments using the x-axis.

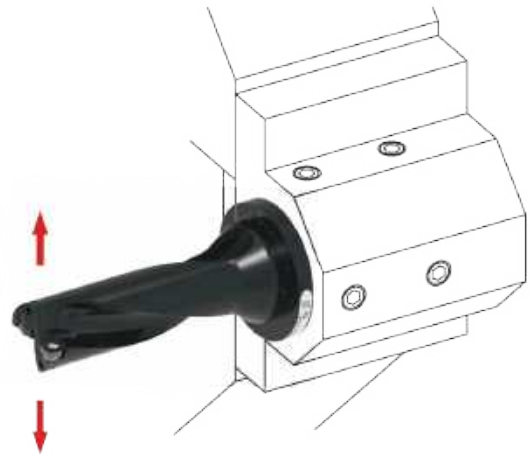

Method 2: Adjustment with Eccentric Sleeve

1. Assemble the drill to the turret using the eccentric sleeve, positioning the center line of the inserts parallel to the x-axis.
2. Align the reference indentation on the drill to the "0" setting on the flange face.
3. Rotate the sleeve (+) or (-) to increase or decrease the center height of the inserts in order to increase or decrease the core diameter at the bottom of the hole.

NOTE: This method still allows diameter adjustments using the x-axis.

NOTE (applies to both methods): Adjusting the center line of the inserts may affect the hole diameter produced. Method two is preferred to make center height adjustments and compensate for hole diameter with the x-axis.





Recommended Cutting Data | Imperial (inch)

T-A® | GEN2 T-A®





Thin Wall Inserts Super Cobalt

ISO	Material	Speed (SFM) - Mist Coolant		Feed Rate (IPR) by Diameter				
		Hardness (BHN)	 AM200® Speed	 TiAlN Speed	0 series (0.5110" - 0.6959")	1 series (0.6900" - 0.9609")	2 series (0.9610" - 1.3809")	3 series (1.3530" - 1.8829")
P	Structural Steel	100 - 150	125	110	0.012	0.018	0.019	0.020
	A36, A285, A516, etc.	150 - 250	115	100	0.011	0.016	0.017	0.019
		250 - 350	105	90	0.010	0.014	0.016	0.018



Notch Point® and 150° Structural Steel Inserts Super Cobalt

ISO	Material	Speed (SFM) - Mist Coolant		Feed Rate (IPR) by Diameter				
		Hardness (BHN)	 AM200® Speed	 TiAlN Speed	0 series (0.5110" - 0.6959")	1 series (0.6900" - 0.9609")	2 series (0.9610" - 1.3809")	3 series (1.3530" - 1.8829")
P	Structural Steel	100 - 150	125	110	0.010	0.012	0.014	0.018
	A36, A285, A516, etc.	150 - 250	115	100	0.009	0.011	0.012	0.016
		250 - 350	105	90	0.008	0.010	0.011	0.014



GEN2 T-A Inserts Super Cobalt

ISO	Material	Speed (SFM) - Mist Coolant		Feed Rate (IPR) by Diameter			
		Hardness (BHN)	 AM200® Speed	0 series (0.5110" - 0.6959")	1 series (0.6900" - 0.9609")	2 series (0.9610" - 1.3809")	3 series (1.3530" - 1.8829")
P	Structural Steel	100 - 150	125	0.010	0.012	0.014	0.018
	A36, A285, A516, etc.	150 - 250	115	0.009	0.011	0.012	0.016
		250 - 350	105	0.008	0.010	0.011	0.014

GEN2 T-A Inserts Carbide C1 (K35)

ISO	Material	Speed (SFM) - Mist Coolant		Feed Rate (IPR) by Diameter			
		Hardness (BHN)	 AM300® Speed	0 series (0.5110" - 0.6959")	1 series (0.6900" - 0.9609")	2 series (0.9610" - 1.3809")	3 series (1.3530" - 1.8829")
P	Structural Steel	100 - 150	165	0.008	0.011	0.015	0.017
	A36, A285, A516, etc.	150 - 250	155	0.006	0.010	0.013	0.015
		250 - 350	140	0.005	0.009	0.012	0.013



NOTE: The speeds and feeds listed above are based on a rigid setup using air mist through tool coolant. Speed may be increased up to 50% if using high pressure flood or through coolant.
NOTE: If drilling dry without coolant, speed must be reduced significantly based on setup, drill depth, and material hardness. Up to 50% speed and feed reduction may be necessary in these types of applications. Contact the Application Engineering department for assistance. ext: 7611 | email: appeng@alliedmachine.com

Recommended Cutting Data | Metric (mm)

T-A® | GEN2 T-A®



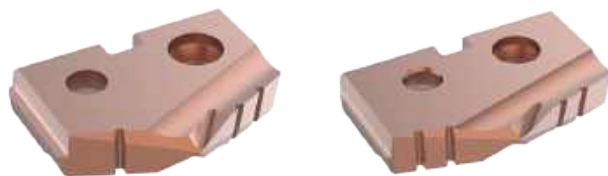

Thin Wall Inserts Super Cobalt

ISO	Material	Speed (M/min) - Mist Coolant		Feed Rate (mm/rev) by Diameter				
		Hardness (BHN)	 AM200® Speed	 TiAlN Speed	0 series (12.98 mm - 17.67 mm)	1 series (17.53 mm - 24.40 mm)	2 series (24.41 mm - 35.06 mm)	3 series (34.37 mm - 47.82 mm)
P	Structural Steel	100 - 150	39	34	0.30	0.45	0.48	0.50
	A36, A285, A516, etc.	150 - 250	35	31	0.28	0.40	0.43	0.48
		250 - 350	32	28	0.25	0.36	0.40	0.45



Notch Point® and 150° Structural Steel Inserts Super Cobalt

ISO	Material	Speed (M/min) - Mist Coolant		Feed Rate (mm/rev) by Diameter				
		Hardness (BHN)	 AM200® Speed	 TiAlN Speed	0 series (12.98 mm - 17.67 mm)	1 series (17.53 mm - 24.40 mm)	2 series (24.41 mm - 35.06 mm)	3 series (34.37 mm - 47.82 mm)
P	Structural Steel	100 - 150	39	34	0.25	0.30	0.36	0.45
	A36, A285, A516, etc.	150 - 250	35	31	0.23	0.28	0.30	0.40
		250 - 350	35	28	0.20	0.25	0.28	0.36



GEN2 T-A Inserts Super Cobalt

ISO	Material	Speed (M/min) - Mist Coolant		Feed Rate (mm/rev) by Diameter			
		Hardness (BHN)	 AM200® Speed	0 series (12.98 mm - 17.67 mm)	1 series (17.53 mm - 24.40 mm)	2 series (24.41 mm - 35.06 mm)	3 series (34.37 mm - 47.82 mm)
P	Structural Steel	100 - 150	39	0.25	0.30	0.36	0.46
	A36, A285, A516, etc.	150 - 250	35	0.23	0.28	0.30	0.40
		250 - 350	35	0.20	0.25	0.28	0.36

GEN2 T-A Inserts Carbide C1 (K35)

ISO	Material	Speed (M/min) - Mist Coolant		Feed Rate (mm/rev) by Diameter			
		Hardness (BHN)	 AM300® Speed	0 series (12.98 mm - 17.67 mm)	1 series (17.53 mm - 24.40 mm)	2 series (24.41 mm - 35.06 mm)	3 series (34.37 mm - 47.82 mm)
P	Structural Steel	100 - 150	50	0.20	0.28	0.38	0.43
	A36, A285, A516, etc.	150 - 250	47	0.15	0.25	0.33	0.38
		250 - 350	43	0.13	0.23	0.30	0.33

NOTE: The speeds and feeds listed above are based on a rigid setup using air mist through tool coolant. Speed may be increased up to 50% if using high pressure flood or through coolant.
NOTE: If drilling dry without coolant, speed must be reduced significantly based on setup, drill depth, and material hardness. Up to 50% speed and feed reduction may be necessary in these types of applications. Contact the Application Engineering department for assistance. ext: 7611 | email: appeng@alliedmachine.com



Recommended Cutting Data

GEN3SYS® XT Pro (XTST)

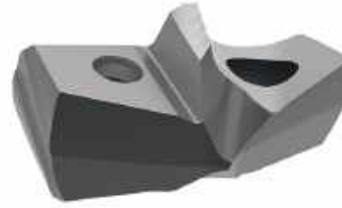

Imperial (inch)

ISO	Material	Speed (SFM) Mist Coolant		Feed Rate (IPR) by Diameter				
		Hardness (BHN)	 AM420 Speed	12 series (0.4724" - 0.5117")	13 series (0.5118" - 0.5511")	14 series (0.5512" - 0.5905")	15 series (0.5906" - 0.6298")	16 series (0.6299" - 0.6692")
P	Structural Steel	100 - 150	350	0.008	0.009	0.010	0.010	0.012
	A36, A285, A516, etc.	150 - 250	300	0.007	0.008	0.009	0.009	0.010
		250 - 350	260	0.006	0.007	0.008	0.008	0.009

Metric (mm)

ISO	Material	Speed (M/min) Mist Coolant		Feed Rate (mm/rev) by Diameter				
		Hardness (BHN)	 AM420 Speed	12 series (12.00 mm - 12.99 mm)	13 series (13.00 mm - 13.99 mm)	14 series (14.00 mm - 14.99 mm)	15 series (15.00 mm - 15.99 mm)	16 series (16.00 mm - 16.99 mm)
P	Structural Steel	100 - 150	107	0.20	0.22	0.25	0.25	0.30
	A36, A285, A516, etc.	150 - 250	91	0.18	0.20	0.23	0.23	0.25
		250 - 350	79	0.15	0.17	0.20	0.20	0.23

Speed and Feed Multiplier

	Depth of Cut	
	<= 1.5xD	> 1.5xD
Speed	See above chart	0.75
Feed	See above chart	0.90

NOTE: The speeds and feeds listed above are based on a rigid setup using air mist through tool coolant. Speed may be increased up to 50% if using high pressure flood or through coolant.

NOTE: If drilling dry without coolant, speed must be reduced significantly based on setup, drill depth, and material hardness. Up to 50% speed and feed reduction may be necessary in these types of applications. Contact the Application Engineering department for assistance. ext: 7611 | email: appeng@alliedmachine.com

NOTE: If drilling material thickness of 0.500" (12.7 mm) or less, a minimum of 10% reduction in feed is required to minimize material deflection.

A

DRILLING

B

BORING

C

REAMING

D

BURNISHING

F

THREADING

X

SPECIALS



A

DRILLING



B

BORING

Feed Rate (IPR) by Diameter

17 series (0.6693" - 0.7086")	18 series (0.7087" - 0.7873")	20 series (0.7874" - 0.8660")	22 series (0.8661" - 0.9448")	24 series (0.9449" - 1.0235")	26 series (1.0236" - 1.1416")	29 series (1.1417" - 1.2597")	32 series (1.2598" - 1.3780")
0.012	0.014	0.015	0.016	0.017	0.018	0.019	0.019
0.010	0.012	0.014	0.015	0.016	0.017	0.018	0.018
0.009	0.011	0.012	0.013	0.014	0.015	0.016	0.016

C

REAMING

Feed Rate (mm/rev) by Diameter

17 series (17.00 mm - 17.99 mm)	18 series (18.00 mm - 19.99 mm)	20 series (20.00 mm - 21.99 mm)	22 series (22.00 mm - 23.99 mm)	24 series (24.00 mm - 25.99 mm)	26 series (26.00 mm - 28.99 mm)	29 series (29.00 mm - 31.99 mm)	32 series (32.00 mm - 35.00 mm)
0.30	0.36	0.38	0.41	0.43	0.46	0.48	0.48
0.25	0.30	0.36	0.38	0.41	0.43	0.46	0.46
0.23	0.28	0.30	0.33	0.36	0.38	0.41	0.41

D

BURNISHING

E

THREADING

X

SPECIALS

NOTE: The speeds and feeds listed above are based on a rigid setup using air mist through tool coolant. Speed may be increased up to 50% if using high pressure flood or through coolant.
NOTE: If drilling dry without coolant, speed must be reduced significantly based on setup, drill depth, and material hardness. Up to 50% speed and feed reduction may be necessary in these types of applications. Contact the Application Engineering department for assistance. ext: 7611 | email: appeng@alliedmachine.com
NOTE: If drilling material thickness of 0.500" (12.7 mm) or less, a minimum of 10% reduction in feed is required to minimize material deflection.



Recommended Drilling Data | Imperial (inch) | Metric (mm)

4TEX® Indexable Drill



Imperial (inch)

ISO	Material	Hardness (BHN)	Speed (SFM)	Feed Rate (IPR) by Diameter - 2xD, 3xD*			
				03, 04 Series (0.472" - 0.591")	05 Series (0.625" - 0.709")	06, 07 Series (0.748" - 1.024")	09, 11, 14 Series (1.063" - 1.562")
P	Structural Steel	100 - 150	330 - 600	0.0015 - 0.0055	0.0025 - 0.0065	0.003 - 0.008	0.003 - 0.008
	A36, A285, A516, etc.	150 - 250	330 - 600	0.0015 - 0.0055	0.0025 - 0.0065	0.003 - 0.008	0.003 - 0.008
		250 - 350	330 - 600	0.0015 - 0.0055	0.0025 - 0.0065	0.003 - 0.008	0.003 - 0.008

*For 4xD tools, begin at low end of feed recommendation.



Metric (mm)

ISO	Material	Hardness (BHN)	Speed (m/min)	Feed Rate (mm/rev) by Diameter - 2xD, 3xD*			
				03, 04 Series (12.00 mm - 15.00 mm)	05 Series (15.88 mm - 18.00 mm)	06, 07 Series (19.00 mm - 26.00 mm)	09, 11, 14 Series (27.00 mm - 39.67 mm)
P	Structural Steel	100 - 150	100 - 185	0.05 - 0.13	0.07 - 0.13	0.08 - 0.13	0.08 - 0.13
	A36, A285, A516, etc.	150 - 250	100 - 185	0.05 - 0.13	0.07 - 0.13	0.08 - 0.13	0.08 - 0.13
		250 - 350	100 - 185	0.05 - 0.13	0.07 - 0.13	0.08 - 0.13	0.08 - 0.13

*For 4xD tools, begin at low end of feed recommendation.



Insert Geometry Recommendations | Troubleshooting

4TEX® Indexable Drill



Insert Geometry Recommendations

ISO	Material	Hardness (BHN)	Geometry				
			P	M	K	N	H
P	Structural Steel A36, A285, A516, etc.	100 - 150	○	●			
		150 - 250	○	●			
		250 - 350	●				○

Troubleshooting

1. Starting on Uneven Surfaces

- Reduce entry feed by 50% if necessary.

2. Starting on Angled Surfaces

- Reduce entry feed by 20 - 50%.
- Use lower rake geometry if insert chipping occurs.

3. Angled Bore Exit

- Reduce entry feed by 50% on breakout.
- Use tough insert and stable corner radius.

4. Starting on Convex Surfaces

- Reduce entry feed by 50%.
- Use lower rake geometry if insert chipping occurs.

5. Drilling Through a Cross Hole

- Reduce feed rate 50% if necessary.
- Use good coolant flow and monitor chip packing.
- Use lower rake geometry if insert chipping occurs.

6. Drilling on a Groove or Large Centering Box

- Reduce entry feed
- Use lower rake geometry for center insert

7. Chain Drilling

- Use good coolant flow.
- Reduce feed rate by 50% for interrupted cut.
- Use lower rake geometry if insert chipping occurs.

8. Starting on an Edge

- Reduce entry feed rate by 50%.
- Use lower rake geometry if insert chipping occurs.

9. Starting on a Welded Seam

- Reduce entry feed rate by 50%.
- Use lower rake geometry if insert chipping occurs.

10. Drilling Through Stacked Plates

- Not recommended.

11. Opening an Existing Hole

- Use flood coolant.

12. Adjustable

- For mills, use eccentric sleeve with end mill holder.
- For lathes, use x-axis to adjust offset ϕ .

NOTE: Refer to maximum offset ϕ in data tables.

A
DRILLING
B
BORING
C
REAMING
D
BURNISHING
E
THREADING
X
SPECIALS

Guaranteed Test / Demo Application Form

Distributor PO #

The following must be filled out completely before your test will be considered.

IMPORTANT: For processing, send purchase order to your Allied Field Sales Engineer (FSE). Please clearly mark the paperwork as "Test Order."

Distributor Information

Company Name: _____
Contact: _____
Account Number: _____
Phone: _____
Email: _____

End User Information

Company Name: _____
Contact: _____
Industry: _____
Phone: _____
Email: _____

Current Process List all tooling, coatings, substrates, speeds and feeds, tool life, and any problems you are experiencing.

Test Objective List what would make this a successful test (i.e. penetration rate, finish, tool life, hole size, etc.).

Application Information

Hole Diameter: _____ in/mm Tolerance: _____ Material: _____
(4150, A36, cast iron, etc.)
Preexisting Diameter: _____ in/mm Depth of Cut: _____ in/mm Hardness: _____
(BHN, Rc)
Required Finish: _____ RMS State: _____
(Casting, hot rolled, forging)

Machine Information

Machine Type: _____ Builder: _____ Model #: _____
(Lathe, screw machine, machine center, etc.) (Haas, Mori Seiki, etc.)
Shank Required: _____ Power: _____ HP/KW
(CAT50, Morse taper, etc.)
Rigidity: Orientation: Tool Rotating: Thrust: _____ lbs/N
 Excellent Vertical Yes
 Good Horizontal No
 Poor

Coolant Information

Coolant Delivery: _____ Coolant Pressure: _____ PSI / bar
(Through tool, flood)
Coolant Type: _____ Coolant Volume: _____ GPM / LPM
(Air mist, oil, synthetic, water soluble, etc.)

Requested Tooling

QTY	Item Number

QTY	Item Number



Allied Machine & Engineering
120 Deeds Drive
Dover, OH 44622

Telephone: (330) 343-4283
Toll Free USA & Canada: (800) 321-5537
Email: info@alliedmachine.com

Warranty Information



Allied Machine & Engineering ("Allied Machine") warrants to original equipment manufacturers, distributors, industrial and commercial users of its products for one year from the original date of sale that each new product manufactured or supplied by Allied Machine shall be free from defects in material and workmanship.

Allied Machine's sole and exclusive obligation under this warranty is limited to, at its option, without additional charge, replacing or repairing this product or issuing a credit. For this warranty to be applied, the product must be returned freight prepaid to the plant designated by an Allied Machine representative and which, upon inspection, is determined by Allied Machine to be defective in material and workmanship.

Complete information as to operating conditions, machine, setup, and the application of cutting fluid should accompany any product returned for inspection. This warranty shall not apply to any Allied Machine products which have been subjected to misuse, abuse, improper operating conditions, improper machine setup or improper application of cutting fluid or which have been repaired or altered if such repair or alteration, in the judgement of Allied Machine, would adversely affect the performance of the product.

THIS WARRANTY IS IN LIEU OF ALL OTHER WARRANTIES, EXPRESS OR IMPLIED, INCLUDING ANY IMPLIED WARRANTY OF MERCHANTABILITY OR FITNESS FOR A PARTICULAR PURPOSE. Allied Machine shall have no liability or responsibility for any claim, whether in contract, tort or otherwise, for any loss or damage arising out of, connected with, or resulting from the manufacture, sale, delivery or use of any product sold hereunder, in excess of the cost of replacement or repair as provided herein.

Allied Machine shall not be liable in contract or in tort (including, without limitation, negligence, strict liability or otherwise) for economic losses of any kind or for any special, incidental, indirect, consequential, punitive or exemplary damages arising in any way out of the performance of, or failure to perform this agreement.

ALL PRICES, DELIVERIES, DESIGNS, AND MATERIALS ARE SUBJECT TO CHANGE WITHOUT NOTICE.



Allied Machine & Engineering is registered to ISO 9001:2015 by DQS.



Wohlhaupter GmbH is registered to ISO 9001:2015 by QUACERT.



Allied Machine & Engineering Co. Europe Ltd. is registered to ISO 9001:2015 by bsi.

United States

Allied Machine & Engineering

120 Deeds Drive
Dover OH 44622
United States

Phone:

+1.330.343.4283

Toll Free USA and Canada:

800.321.5537

Toll Free USA and Canada:

800.223.5140

Allied Machine & Engineering

485 W Third Street
Dover OH 44622
United States

Phone:

+1.330.343.4283

Toll Free USA and Canada:

800.321.5537

Europe

Allied Machine & Engineering Co. (Europe) Ltd

93 Vantage Point
Pensnett Estate
Kingswinford
West Midlands
DY6 7FR England

Phone:

+44 (0) 1384 400 900

Wohlhaupter® GmbH

Maybachstrasse 4
Postfach 1264
72636 Frickenhausen
Germany

Phone:

+49 (0) 7022 408-0

Asia

Wohlhaupter® India Pvt. Ltd.

B-23, 3rd Floor
B Block Community Centre
Janakpuri, New Delhi - 110058
India

Phone:

+91 (0) 11.41827044

Your local Allied Machine representative:

www.alliedmachine.com

Allied Machine & Engineering is registered to **ISO 9001:2015** by DQS.

Wohlhaupter GmbH is registered to **ISO 9001:2015** by QUACERT.

Allied Machine & Engineering Co. (Europe) Ltd is registered to **ISO 9001:2015** by bsi.

