



ALLIED MACHINE & ENGINEERING

Holemaking Solutions for Today's Manufacturing



Drilling



Boring



Burnishing



Threading



Specials



ALVAN[®] Reamers

► *REAMING*

Finishing Solutions by S.C.A.M.I.[®]

S.C.A.M.I.[®]

SECTION

C

Reaming

ALVAN® Reamers

Replaceable Head Style | Monobloc Style | Cutting Ring Style



Every Option for Every Application

Allied Machine & Engineering is pleased to offer ALVAN® Reamers through an exclusive supply agreement with S.C.A.M.I. s.n.c., an Italian manufacturer that provides high-quality cutting tools.

In addition to producing close tolerances and dimensional accuracy of machined holes, these high performance reaming products provide lower costs per hole through high-penetration rates, making them the ideal choice for finishing holes in a production environment. It can also prove to be an alternative to finish boring by providing more consistent hole sizes and lower cycle times.

Excellent hole tolerances	Improves hole quality and surface finish	Expandable design accommodates for wear
---------------------------	--	---

Applicable Industries

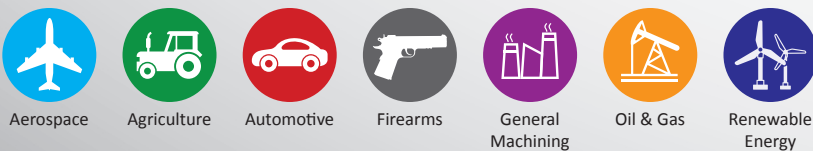

Your safety and the safety of others is very important. This catalog contains important safety messages. Always read and follow all safety precautions.



This triangle is a safety hazard symbol. It alerts you to potential safety hazards that can cause tool failure and serious injury.

When you see this symbol in the catalog, look for a related safety message that may be near this triangle or referred to in the nearby text.

There are safety signal words also used in the catalog. Safety messages follow these words.

WARNING

WARNING (shown above) means that failure to follow the precautions in this message could result in tool failure and serious injury.

NOTICE means that failure to follow the precautions in this message could result in damage to the tool or machine but not result in personal injury.

NOTE and **IMPORTANT** are also used. These are important that you read and follow but are not safety-related.

Visit www.alliedmachine.com for the most up-to-date information and procedures.

Reference Icons

The following icons will appear throughout the catalog to help you navigate between products.



Setup / Assembly Information
Detailed instructions and information regarding the corresponding part(s)

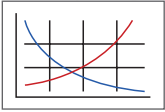

Recommended Cutting Data
Speed and feed recommendations for optimum and safe reaming

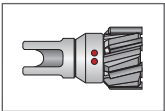

Replaceable Reamer Heads
Refers to the reamer head options that connect to the reamer mandrels

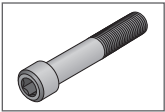

Replaceable Reamer Screws
Refers to the reamer head screw options that connect the head to the reamer mandrels

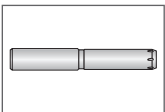

Replaceable Reamer Mandrels
Refers to the reamer mandrel options that connect with the head and screw



Cutting Rings
Refers to the available cutting ring options



Coolant-Through Option
Indicates that the product is coolant through



Allied Machine & Engineering offers ALVAN® Reamers through an exclusive supply agreement with S.C.A.M.I. s.n.c.

S.C.A.M.I. is an Italian manufacturer that has been producing high-quality cutting tools for over 40 years. In addition to producing close tolerances and dimensional accuracy of machined holes, this high-performance reaming product provides a lower cost per hole through its high penetration rates. This makes the ALVAN Reamer product line an ideal choice for finishing holes in a production environment. It can also prove to be an alternative to finish boring by providing more consistent hole sizes and lower cycle times.

For additional information about all Allied Machine products, visit www.alliedmachine.com. For technical assistance, contact our Application Engineering department.
ext: 7611 | email: appeng@alliedmachine.com

Introduction Information

Case Study Example 2
Reconditioning Service 3
Reaming Overview and Selection 4 - 7
Lead-ins, Coatings, Materials, and Dimples 8 - 9

Replaceable Head Reamers

Product Overview 10
Product Nomenclature 11
 Heads 12 - 13
 Screws 14 - 15
 Mandrels 16 - 19

Monobloc Reamers

Product Overview 20
Product Nomenclature 21
Monobloc Reamers 22 - 27

Ring Style Reamers

Product Overview 28
Product Nomenclature 29
 Cutting Rings 30 - 31
 Mandrels 32 - 51

Shanks

Radial Adjusting Shanks 52 - 57
Radial Adjusting Adapters 58 - 59

Recommended Cutting Data

Imperial (inch)	[Replaceable Head Style 60 - 61
		Monobloc Style 62 - 63
		Cutting Ring Style 64 - 65
Metric (mm)	[Replaceable Head Style 66 - 67
		Monobloc Style 68 - 69
		Cutting Ring Style 70 - 71

Technical Information

Setup: Replaceable Head Style 72
Setup: Monobloc Style 73
Setup: Cutting Ring Style 74
Diameter Measurement 75
TIR Measurement and Adjustment 76 - 77
Troubleshooting Guide 78

Case Study Example

A DRILLING
B BORING
C REAMING
D BURISHING
E THREADING
X SPECIALS

CASE STUDY



The **PROOF** is in the **NUMBERS**

Project Profile: Grey Cast Iron Hydraulic Transmission Component
Tooling Solution: ALVAN® Reamer - Monobloc Style

The Problem:

Previously, the customer was using a competitor boring tool running at the following parameters:

- 3802 RPM
- 500 SFM
- 0.003 IPR
- 11.41 IPM

With 2 passes, the tool made a 0.5023" diameter hole to a 1.20" depth.

- Cycle time = 12.6 seconds
- Tool life = 75 parts

Seeking to streamline the production process, the customer needed to increase tool life and lower the cost of production.

The Solution:

Allied Machine recommended the ALVAN® monobloc style reamer.

- **Reamer** = 92440 series carbide, uncoated, V lead

The tool ran at the following parameters:

- 2200 RPM
- 289 SFM
- 0.019 IPR
- 41.80 IPM

The tool achieved the desired diameter and depth, and the results achieved the customer's goals.

- Cycle time = 1.7 seconds
- Tool life = 3,176 parts

The Advantages:

The customer was able to lower the cost of production and increase the tool life.

- Reduced cycle time *from 12.6 seconds to 1.7 seconds*
- Increased tool life *from 75 parts to an incredible 3,176 parts*
- Total cost savings = **\$2,407 (or 52%)**



Tool Life: Competitor Boring
(number of parts = 75)



Tool Life: ALVAN® Monobloc Style Reamer
(number of parts = 3,176)

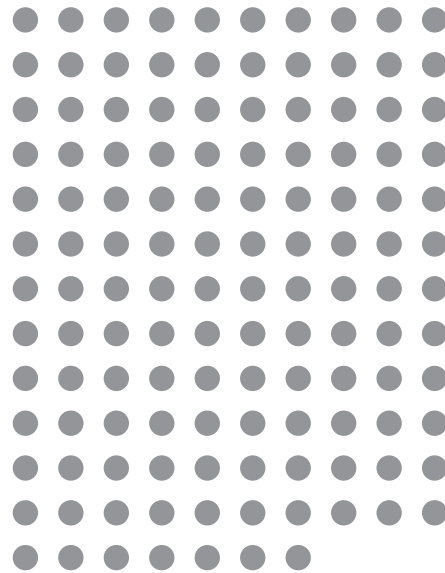



Overall **SAVINGS** of **52%**

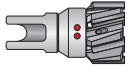

Reconditioning Service

All ALVAN Reamers can be reconditioned to help reduce your overall tooling costs. This service is provided through Allied Machine & Engineering by utilizing the expertise of S.C.A.M.I. We will process the tools with a 25-35 work day lead time, depending on the style, the date we receive the tools, and the purchase order.

Reamer Style	Lead Time (work days)	Part No.	Reconditioned Part No.
 Replaceable Head	25	I7405-SVG-10000	RI7405SVG10000
 Monobloc	35	AL3620I04853	AL3620I04853 RP1
 Cutting Ring	35	AL2TIAI05820	AL2TIAI05820 RP1



Parts to be Reconditioned
(packaged safely)



Purchase Order



Allied Machine & Engineering
Attn: Re grind Department
120 Deeds Drive
Dover, OH 44622
United States

Reaming Overview

A
DRILLING
B
BORING
C
REAMING
D
BURNISHING
E
THREADING
X
SPECIALS

REAMER STYLES



Replaceable Head
Pages C: 10 - 19

- Diameter range: 11.80 mm - 60.60 mm
- Heads are available as fixed or expanding for improved productivity
- Straight, left-hand, or right-hand helical flutes provide solutions for both through and blind holes
- Cylindrical or modular shanks improve concentricity



Monobloc
Pages C: 20 - 29

- Diameter range: 5.80 mm - 32.10 mm
- Available with central or radial through coolant
- Can be used for through or blind holes
- Cylindrical shanks improve concentricity
- Expandable to accommodate for wear



Cutting Ring
Pages C: 30 - 53

- Diameter range: 17.60 mm - 200.60 mm
- The cutting edges are positioned asymmetrically to assure the best roundness of the hole
- Holes with tight tolerances can be accommodated, and the expansion ensures a perfect holding of the reaming diameter

General Reaming Notes

- If the depth is over 9xD, use a short length reamer to pilot the hole. Then finish with the longer length ⚠.
- For blind hole applications, always use central coolant. If in doubt, contact Allied's Application Engineering department.
- More stock allowance can be taken in softer materials. Less stock allowance should be taken in harder materials.
- A common practice to rapid out of the cut on through holes and to breakout only 2mm past the reaming depth.

IMPORTANT: Always use Molykote® (anti-seize applicant) on the conical seat and the threads on the central screw for assembly.

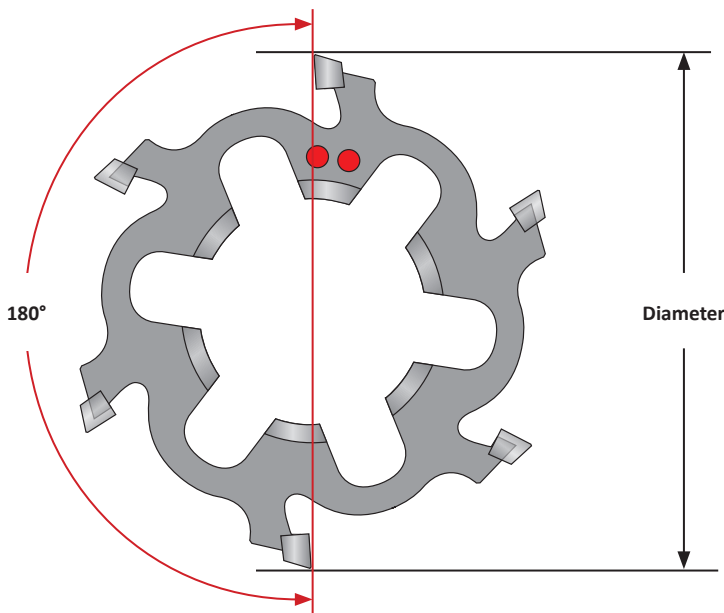
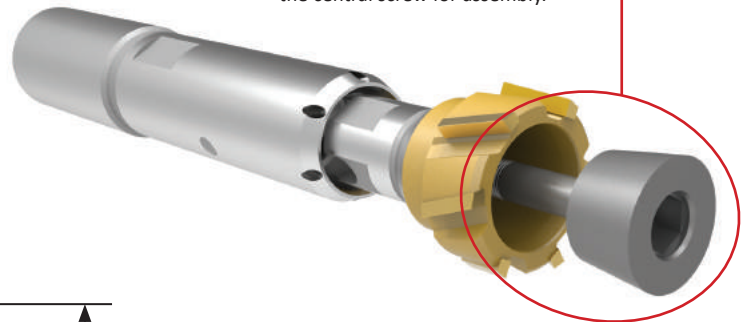

NOTE: The position of the dimples indicates which two cutting teeth are 180° opposed. Diameter measurements should be taken from these two cutting teeth.



⚠ WARNING Tool failure can cause serious injury. To prevent:

- When using holders without support bushing, use a shorter reamer to establish the initial hole diameter that is a minimum of 2 diameters deep.
- Do not rotate reamers more than 50 RPM unless it is engaged with the workpiece or fixture.

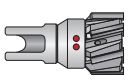
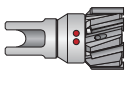
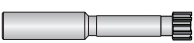

Factory technical assistance is available for your specific applications through our Application Engineering Team. ext: 7611 | email: appeng@alliedmachine.com

Quick Selection Guide

Breakdown by Diameter

Reamer Style	0.2283" 5.79 mm	0.4656" 11.80 mm	0.6929" 17.60 mm	1.1024" 28.00 mm	1.2638" 32.10 mm	1.7717" 45.00 mm	2.3858" 60.60 mm	3.7402" 95.00 mm	5.1181" 130.00 mm	6.4961" 165.00 mm	7.8975" 200.60 mm
 Replaceable Head (Fixed)		[Red bar]									
 Replaceable Head (Expandable)		[Red bar]									
 Monobloc	[Red bar]										
 Cutting Ring		[Red bar]									

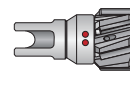
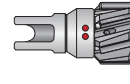
Breakdown by Features

Reamer Style	Capable Tolerance	Fastest Setup	Replaceable Cutting Head	Expandable to Adjust for Wear	Recondition Available	Cylindrical Shanks	Modular Shanks	Through-Coolant Options
 Replaceable Head (fixed)	H7	<input checked="" type="checkbox"/>	<input checked="" type="checkbox"/>		<input checked="" type="checkbox"/>	<input checked="" type="checkbox"/>	<input checked="" type="checkbox"/>	<input checked="" type="checkbox"/>
 Replaceable Head (expandable)	H6		<input checked="" type="checkbox"/>	<input checked="" type="checkbox"/>	<input checked="" type="checkbox"/>	<input checked="" type="checkbox"/>	<input checked="" type="checkbox"/>	<input checked="" type="checkbox"/>
 Monobloc	H6			<input checked="" type="checkbox"/>	<input checked="" type="checkbox"/>	<input checked="" type="checkbox"/>		<input checked="" type="checkbox"/>
 Cutting Ring	H6		<input checked="" type="checkbox"/>	<input checked="" type="checkbox"/>	<input checked="" type="checkbox"/>	<input checked="" type="checkbox"/>	<input checked="" type="checkbox"/>	<input checked="" type="checkbox"/>

For more details on how to select a reamer, see the following pages.

How the Reamer Works

How the Reamer Works

- The cut is made in the lead-in zone (3), and the chip is made on the cutting face (1). The chip is removed by coolant.
- The lead-in (3) is defined depending on the application, the workpiece material, and the stock allowance.
- The radial land (2) is important for holding a good alignment, improving the surface roughness, and giving an effect similar to burnishing. The dimension of the radial land depends on the diameter.
- The radial land (2) is manufactured to be tapered on the rear.
- Fixed reamers are manufactured at the exact tapered value. Expandable reamers must be adjusted to the exact diameter. Both are already supplied at the nominal diameter by the manufacturer.
- The undercut of the cutting edge (5) avoids retract marks on the piece when the reamer is retracted from the cut.
- The front of the cutting edge (6) does not cut; if this feature is needed, a frontal lead must be supplied.

When to Apply a Reamer

- When the requested tolerance on diameter is IT8 or less
- When the requested finish is 63 µin (1.6 µmm) Ra or greater
- When the critical geometry characteristics of the hole are the roundness and straightness
- When parts are being mass produced
- When the parts are large and expensive

Elements of the Cutting Tooth

- (1) Cutting Face
- (2) Radial Land
- (3) Lead-in / Primary Face / Secondary Face
- (4) Rear Face
- (5) Undercut of Cutting Edge
- (6) Front of Cutting Edge

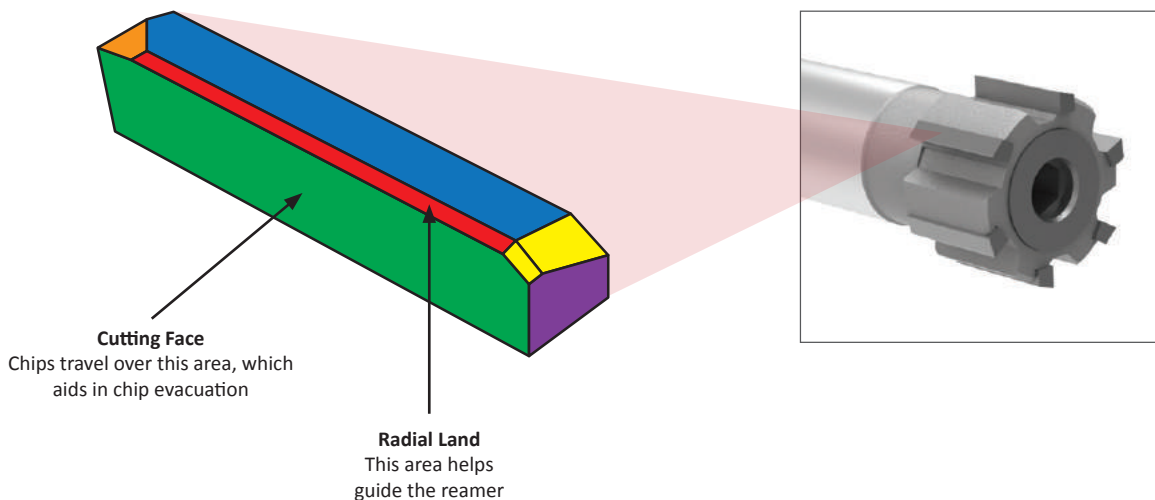











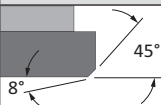

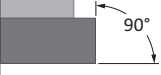

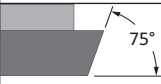

Reamer Recommendation Guide

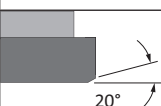
ISO	Material	Hardness (BHN)	Through Hole				Blind Hole			
			Uninterrupted		Interrupted		Uninterrupted		Interrupted	
			Lead	Substrate & Coating	Lead	Substrate & Coating	Lead	Substrate & Coating	Lead	Substrate & Coating
P	Free-Machining Steel 1118, 1215, 12L14, etc.	Below 150	N or E	Cermet Uncoated	E	Cermet Uncoated	K	Cermet Uncoated	V	Cermet Uncoated
		150 Above								
	Low-Carbon Steel 1010, 1020, 1522, 1144, etc.	Below 250	N or E	Cermet Uncoated	E	Cermet Uncoated	K	Cermet Uncoated	V	Cermet Uncoated
	Medium-Carbon Steel 1030, 1040, 1050, 1140, 1151, etc.	Below 300	N or E	Cermet Uncoated	E	Cermet Uncoated	K*	Cermet Uncoated	V	Cermet Uncoated
	Alloy Steel 4140, 5140, 8640, etc.	Below 350	G or M*	Cermet Uncoated	M*	Cermet Uncoated	K*	Cermet Uncoated	G*	Cermet Uncoated
	High-Strength Alloy 4340, 4330V, 300M, etc.	240 - 450	G or M*	Carbide Alcrona	M*	Carbide Alcrona	K*	Carbide Alcrona	G*	Carbide Alcrona
	Structural Steel	–	E	Cermet	M	Carbide TiAlN	K	Cermet	G	Carbide TiAlN
Tool Steel	–	M*	Carbide TiAlN	M*	Carbide TiAlN	K*	Carbide TiAlN	G*	Carbide TiAlN	
S	High-Temp Alloy	–	G*	Carbide TiAlN	G*	Carbide TiAlN	K*	Carbide TiAlN	G*	Carbide TiAlN
	Titanium Alloys	–	T	Carbide TiAlN	T	Carbide TiAlN	T	Carbide TiAlN	T	Carbide TiAlN
M	Austenitic Stainless Steel 304, 316, etc.	–	E	Carbide Alcrona	E	Carbide Alcrona	K	Carbide Alcrona	G*	Carbide Alcrona
	Ferritic Martensitic Stainless Steel 416, 420, 17-4PH, 15-5PH, etc.	–	N or E	Cermet or Carbide Alcrona	E	Cermet or Carbide Alcrona	K	Cermet or Carbide Alcrona	G	Cermet or Carbide Alcrona
K	Ductile Cast Iron Spheroidal - GS500	Below 130	V	Carbide Alcrona	V	Carbide Alcrona	K	Carbide Alcrona	V	Carbide Alcrona
		130 Above		Cermet Alcrona		Cermet Alcrona		Cermet Alcrona		
	Grey Cast Iron GC15 - GC20 - GC25 - GC35	–	V	Carbide TiAlN	V	Carbide TiAlN	K	Carbide TiAlN	V	Carbide TiAlN
N	Bronze Brass Copper	Below 300	E	Carbide Uncoated	E	Carbide Uncoated	K	Carbide Uncoated	G	Carbide Uncoated
	Aluminum	Below 7% Si	V	Carbide Uncoated	V	Carbide Uncoated	V	Carbide Uncoated	G	Carbide Uncoated
		Above 7% Si	G	PCD Uncoated	G	PCD Uncoated	G	PCD Uncoated		PCD Uncoated

*Contact our Application Engineering department for special geometries to improve tool life.

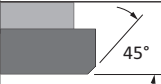
Lead-in Angle Information

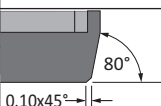



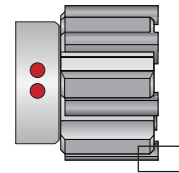

Straight Flute

Lead-in	Angles	Chip Evacuation	Description
A			Lead-in can be used to improve finish.
F			Can be used for stock removal at the bottom of the hole. Reduce the feed by 40% of the values on the recommended cutting data pages.
G			Standard and suitable for most materials.
L			May provide improved straightness. Reduce the feed by 40% of the values on the recommended cutting data pages.
N			Ideal for through holes. It is possible to increase the feed up to 100% of the values on the recommended cutting data pages.
T			Suitable for titanium based alloys.
V			Suitable for most materials and increases tool life
K			Excellent at breaking small chips that are easy to evacuate in blind hole applications. Requires 50% increased feed rate, which will result in reduced tool life when compared to other leads.

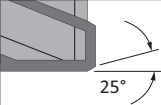

Straight

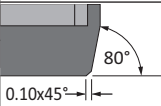

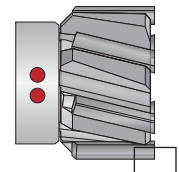

Helical Flute (Right-Hand) - Blind Hole Applications Only

Lead-in	Angles	Chip Evacuation	Description
E			Standard and suitable for most materials.
M			May provide better penetration rates in steels over 200 BHN.
K			Excellent at breaking small chips that are easy to evacuate in blind hole applications. Requires 50% increased feed rate, which will result in reduced tool life when compared to other leads.

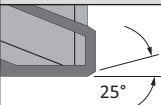

Helical

Helical Flute (Left-Hand) - Through Hole Applications Only

Lead-in	Angles	Chip Evacuation	Description
E			Standard and suitable for most materials. NOTE: Through hole applications only.
M			May provide better penetration rates in steels over 200 BHN. NOTE: Through hole applications only.

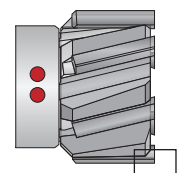

Helical

Coatings, Cutting Materials, and Dimple Indicators



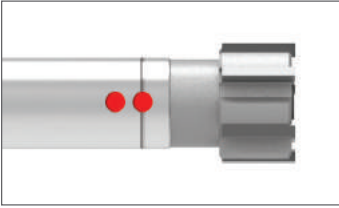
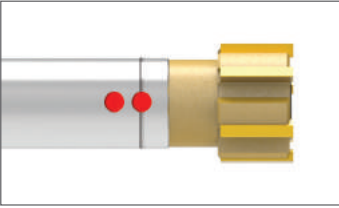
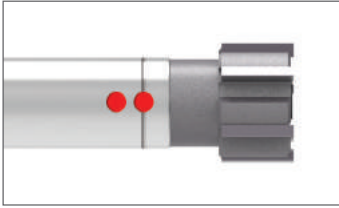
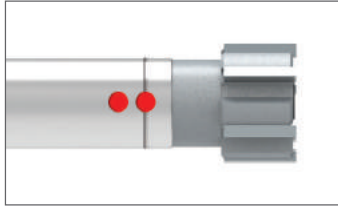
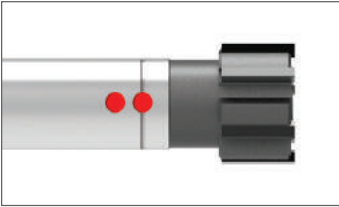
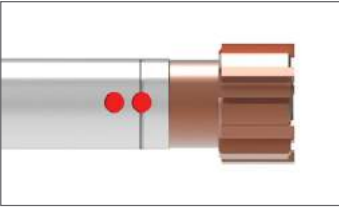
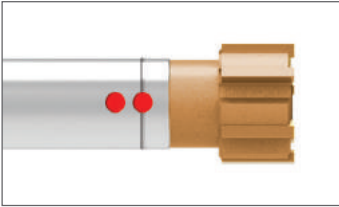
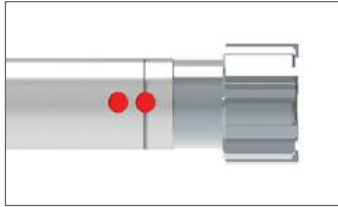



Coating Information

			
Uncoated Ideal for nonferrous applications	TiN (N) Ideal for general purpose applications	TiAlN (A) Provides higher heat resistance to improve tool life	TiCN (C) Provides improved surface finish
			
Alcrona (K) Provides excellent wear resistance and can help increase cutting speeds	Hardcut (H) Ideal for cast iron and hardened steel applications	R Coating (R) Improved tool life in cast iron materials	T Coating (T) Optimized tool life in Titanium and very hard materials

Cutting Material Information

Material	Indicator	Details
Carbide	K	A fine-grain carbide suitable for all conventional reaming applications. Recommended where rigidity is not excellent and speeds must be reduced.
Cermet	S	Cermet provides high wear resistance and is recommended for abrasive and increased speed applications. Not recommended for poor rigidity or interrupted cuts.

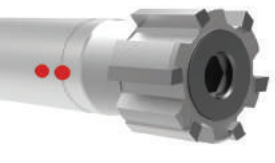
Dimple Indicators

Material	Indicator	Replaceable Head Style	Monobloc Style	Cutting Ring Style
Carbide	Two Dimples			
Cermet	Two Dimples with Line			

NOTE: The dimple location also indicates which 2 cutting teeth are 180° opposed

Replaceable Head Reamers

Product Overview

Fixed Heads

- Nonexpanding diameter
- Locking screw is straight (no taper)
- Allows for on-machine replacement
- Capable of H7 tolerance on diameter
- Available in straight, left-hand, and right-hand helical flutes
- Available for recondition

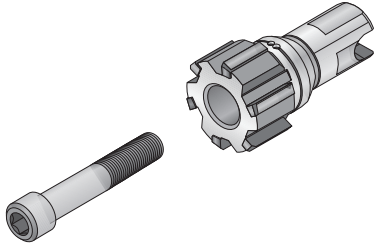

Expandable Heads

- Expandable diameter (1% of nominal diameter) to accommodate for wear
- Conical locking screw
- Requires setup for diameter
- Capable of tight diameter tolerance ($\pm 0.0002''$ (0.005 mm))
- Available in straight, left-hand, and right-hand helical flutes
- Available for recondition

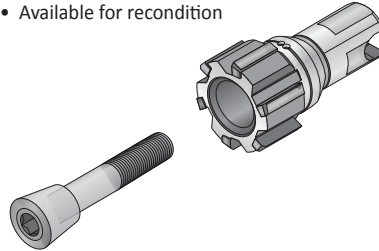

Mandrels

- Available in short, standard, and long lengths
- Reamer head design allows multiple diameters to be used within the same mandrel, **which reduces inventory requirements**
- The same mandrel can use both fixed and expandable heads
- Coolant options are offered for both through and blind hole scenarios

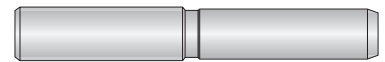

Uncoated



TiN Coated



TiAlN Coated



TiCN Coated



Alcrona Coated



Hardcut Coated

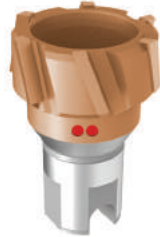

R Coated



T Coated

Mandrel Shanks Available:

- Cylindrical
- Modular Connection

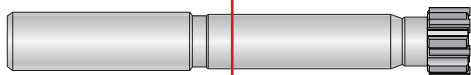

Short Length

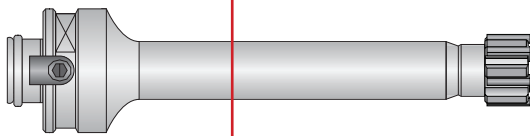

Standard Length



Long Length

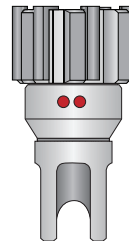

Straight Flute

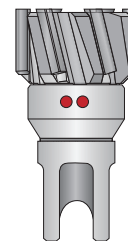

Left-Hand Helical Flute

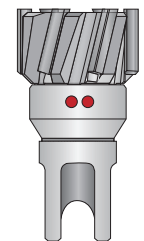

Right-Hand Helical Flute

Type of Head	Coated/ Uncoated	Lead Time in Work Days (based on number of pieces)		
		Up to 5	6 - 19	20+
Fixed	Coated	20	25	25
	Uncoated	15	20	20
Expandable	Coated	20	25	30
	Uncoated	15	20	25

Product Nomenclature

Replaceable Head Style Reamer Heads

I	77	00	-	K	N	G	-	18000
1	2	3		4	5	6		7

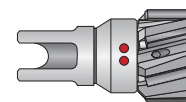

NOTE: For reconditions, put an "R" at the beginning of the item number

1. Diameter Unit of Measure	2. Flute Style	3. Head Style	4. Substrate	5. Coating
Blank = Metric diameter (mm) I = Imperial diameter (in)	74 = Straight 76 = Right-hand helical 77 = Left-hand helical	00 = Fixed head 05 = Expandable head	K = Carbide S = Cermet	L = Uncoated carbide V = Uncoated cermet N = TiN C = TiCN A = TiAlN K = Alcrona H = Hardcut R = R Coating T = T Coating
6. Lead-in	7. Diameter			
E, M = Right-hand and left-hand helical flute A, F, G, L, N, T, V = Straight flute K = Chipbreaker geometry for straight or right-hand helical flute	X.XXXX = Imperial (inch) XX.XXX = Metric (mm)			

Reference Key

Symbol	Attribute
D_1	Reamer head diameter
D_2	Shank diameter
L_1	Overall length
L_2	Length of cut
H	Hex key (listed with screws)

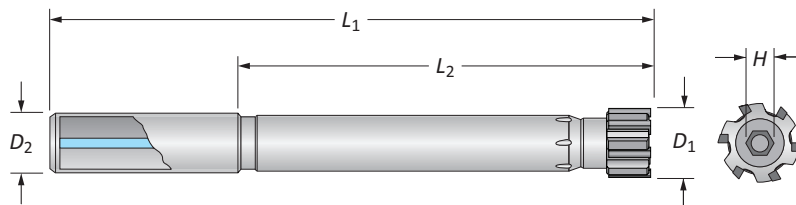

Building Your Complete Tool

You will need all three pieces to complete your replaceable head reamer assembly. The item numbers for the screws and the mandrels are listed on their respective pages. However, there is a guide on the pages where the heads are located. You must follow the guide to build the item number for the reamer head that you need.

The complete mandrel item numbers are listed on their respective pages. You do not need to build the mandrel numbers.

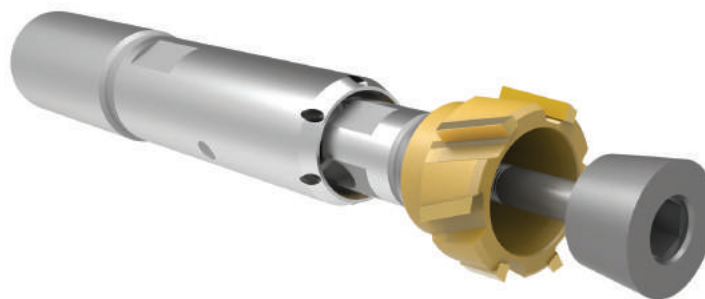



1

Select Your Head

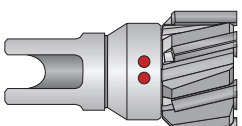



2

Select Your Screw

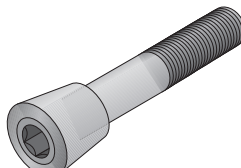



3

Select Your Mandrel



Replaceable Heads

Fixed

Build Your Part No.

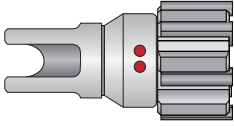
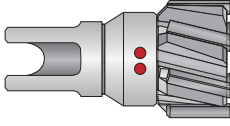
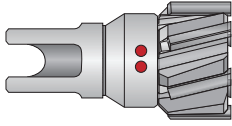
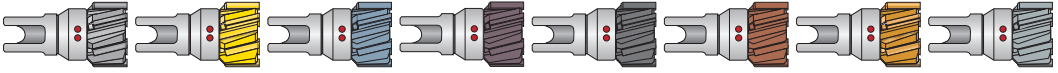
1 Series	7400 Series	7600 Series	7700 Series																																																																																																																
2 Flute Style	Straight Flute 	Helical Flute (Right-Hand) 	Helical Flute (Left-Hand) 																																																																																																																
3 Carbide Grade and Coating Codes	 <table border="1" style="margin-top: 10px;"> <thead> <tr> <th></th> <th>Uncoated</th> <th>TiN</th> <th>TiCN</th> <th>TiAlN</th> <th>Alcrona</th> <th>Hardcut</th> <th>R Coating</th> <th>T Coating</th> </tr> </thead> <tbody> <tr> <th>Carbide</th> <td>KL</td> <td>KN</td> <td>KC</td> <td>KA</td> <td>KK</td> <td>KH</td> <td>KR</td> <td>KT</td> </tr> <tr> <th>Cermet</th> <td>SV</td> <td>SN</td> <td>SC</td> <td>SA</td> <td>SK</td> <td>SH</td> <td>SR</td> <td>ST</td> </tr> </tbody> </table>				Uncoated	TiN	TiCN	TiAlN	Alcrona	Hardcut	R Coating	T Coating	Carbide	KL	KN	KC	KA	KK	KH	KR	KT	Cermet	SV	SN	SC	SA	SK	SH	SR	ST																																																																																					
	Uncoated	TiN	TiCN	TiAlN	Alcrona	Hardcut	R Coating	T Coating																																																																																																											
Carbide	KL	KN	KC	KA	KK	KH	KR	KT																																																																																																											
Cermet	SV	SN	SC	SA	SK	SH	SR	ST																																																																																																											
4 Lead-in Recommendations	<table border="1"> <thead> <tr> <th></th> <th>T</th> <th>F</th> <th>N</th> <th>G</th> <th>L</th> <th>A</th> <th>V</th> <th>K</th> </tr> </thead> <tbody> <tr> <th>P</th> <td></td> <td></td> <td>●</td> <td>●</td> <td></td> <td>○</td> <td>○</td> <td>○</td> </tr> <tr> <th>S</th> <td>●</td> <td></td> <td></td> <td>○</td> <td></td> <td></td> <td></td> <td></td> </tr> <tr> <th>M</th> <td></td> <td></td> <td>○</td> <td>●</td> <td></td> <td></td> <td></td> <td>○</td> </tr> <tr> <th>H</th> <td></td> <td></td> <td>○</td> <td>●</td> <td></td> <td></td> <td></td> <td></td> </tr> <tr> <th>K</th> <td></td> <td></td> <td></td> <td>○</td> <td></td> <td></td> <td>●</td> <td>○</td> </tr> <tr> <th>N</th> <td></td> <td></td> <td></td> <td>●</td> <td></td> <td></td> <td>○</td> <td></td> </tr> </tbody> </table>		T	F	N	G	L	A	V	K	P			●	●		○	○	○	S	●			○					M			○	●				○	H			○	●					K				○			●	○	N				●			○		<table border="1"> <thead> <tr> <th></th> <th>E</th> <th>M</th> <th>K</th> </tr> </thead> <tbody> <tr> <th>P</th> <td>●</td> <td></td> <td>○</td> </tr> <tr> <th>S</th> <td>●</td> <td>○</td> <td></td> </tr> <tr> <th>M</th> <td>●</td> <td></td> <td>○</td> </tr> <tr> <th>H</th> <td>○</td> <td>●</td> <td></td> </tr> <tr> <th>K</th> <td>○</td> <td>●</td> <td>○</td> </tr> <tr> <th>N</th> <td>●</td> <td>○</td> <td></td> </tr> </tbody> </table>		E	M	K	P	●		○	S	●	○		M	●		○	H	○	●		K	○	●	○	N	●	○		<table border="1"> <thead> <tr> <th></th> <th>E</th> <th>M</th> </tr> </thead> <tbody> <tr> <th>P</th> <td>●</td> <td></td> </tr> <tr> <th>S</th> <td>●</td> <td>○</td> </tr> <tr> <th>M</th> <td>●</td> <td></td> </tr> <tr> <th>H</th> <td>○</td> <td>●</td> </tr> <tr> <th>K</th> <td>○</td> <td>●</td> </tr> <tr> <th>N</th> <td>●</td> <td>○</td> </tr> </tbody> </table>		E	M	P	●		S	●	○	M	●		H	○	●	K	○	●	N	●	○
	T	F	N	G	L	A	V	K																																																																																																											
P			●	●		○	○	○																																																																																																											
S	●			○																																																																																																															
M			○	●				○																																																																																																											
H			○	●																																																																																																															
K				○			●	○																																																																																																											
N				●			○																																																																																																												
	E	M	K																																																																																																																
P	●		○																																																																																																																
S	●	○																																																																																																																	
M	●		○																																																																																																																
H	○	●																																																																																																																	
K	○	●	○																																																																																																																
N	●	○																																																																																																																	
	E	M																																																																																																																	
P	●																																																																																																																		
S	●	○																																																																																																																	
M	●																																																																																																																		
H	○	●																																																																																																																	
K	○	●																																																																																																																	
N	●	○																																																																																																																	
5 Diameter (H7 Tolerance)	<table border="1" style="width: 100%;"> <thead> <tr> <th colspan="2">Imperial (in)</th> <th colspan="2">Metric (mm)</th> </tr> <tr> <th>D₁ Range</th> <th>Tolerance (min/max)</th> <th>D₁ Range</th> <th>Tolerance (min/max)</th> </tr> </thead> <tbody> <tr> <td>0.4656 - 0.7086</td> <td>+0 / +0.0007</td> <td>11.800 - 18.000</td> <td>+0 / +0.018</td> </tr> <tr> <td>0.7087 - 1.1811</td> <td>+0 / +0.0008</td> <td>18.001 - 30.000</td> <td>+0 / +0.021</td> </tr> <tr> <td>1.1812 - 1.9685</td> <td>+0 / +0.0010</td> <td>30.001 - 50.000</td> <td>+0 / +0.025</td> </tr> <tr> <td>1.9686 - 2.3858</td> <td>+0 / +0.0012</td> <td>50.001 - 60.600</td> <td>+0 / +0.030</td> </tr> </tbody> </table> <p>For the diameter portion of the item number, refer to the following tables:</p>			Imperial (in)		Metric (mm)		D ₁ Range	Tolerance (min/max)	D ₁ Range	Tolerance (min/max)	0.4656 - 0.7086	+0 / +0.0007	11.800 - 18.000	+0 / +0.018	0.7087 - 1.1811	+0 / +0.0008	18.001 - 30.000	+0 / +0.021	1.1812 - 1.9685	+0 / +0.0010	30.001 - 50.000	+0 / +0.025	1.9686 - 2.3858	+0 / +0.0012	50.001 - 60.600	+0 / +0.030																																																																																								
Imperial (in)		Metric (mm)																																																																																																																	
D ₁ Range	Tolerance (min/max)	D ₁ Range	Tolerance (min/max)																																																																																																																
0.4656 - 0.7086	+0 / +0.0007	11.800 - 18.000	+0 / +0.018																																																																																																																
0.7087 - 1.1811	+0 / +0.0008	18.001 - 30.000	+0 / +0.021																																																																																																																
1.1812 - 1.9685	+0 / +0.0010	30.001 - 50.000	+0 / +0.025																																																																																																																
1.9686 - 2.3858	+0 / +0.0012	50.001 - 60.600	+0 / +0.030																																																																																																																





● Best ○ Better ○ Good

Ordering Example:

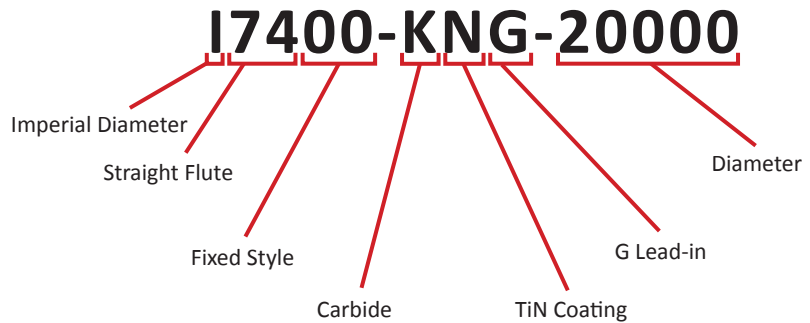
The customer needs the following:

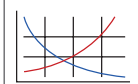
- Straight fluted reamer head
- Fixed style
- Carbide
- TiN coating
- G lead-in
- 2.0000" diameter
- H7 tolerance +0/ +0.0012" for 2.0000" diameter

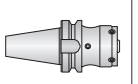

C: 60 - 71 	C: 14 - 15 	C: 16 - 19 	C: 52 - 57 	C: 72 
---	---	---	---	--

Key on C: 1



Replaceable Heads

Expandable

Build Your Part No.

1 Series	7405 Series	7605 Series	7705 Series																																																																																																																
2 Flute Style Your flute style is based on your series selection (above)	Straight Flute 	Helical Flute (Right-Hand) 	Helical Flute (Left-Hand) 																																																																																																																
3 Carbide Grade and Coating Codes These are the combinations of grades and coatings you can choose from	<table border="1"> <thead> <tr> <th></th> <th>Uncoated</th> <th>TiN</th> <th>TiCN</th> <th>TiAlN</th> <th>Alcrona</th> <th>Hardcut</th> <th>R Coating</th> <th>T Coating</th> </tr> </thead> <tbody> <tr> <th>Carbide</th> <td>KL</td> <td>KN</td> <td>KC</td> <td>KA</td> <td>KK</td> <td>KH</td> <td>KR</td> <td>KT</td> </tr> <tr> <th>Cermet</th> <td>SV</td> <td>SN</td> <td>SC</td> <td>SA</td> <td>SK</td> <td>SH</td> <td>SR</td> <td>ST</td> </tr> </tbody> </table>				Uncoated	TiN	TiCN	TiAlN	Alcrona	Hardcut	R Coating	T Coating	Carbide	KL	KN	KC	KA	KK	KH	KR	KT	Cermet	SV	SN	SC	SA	SK	SH	SR	ST																																																																																					
	Uncoated	TiN	TiCN	TiAlN	Alcrona	Hardcut	R Coating	T Coating																																																																																																											
Carbide	KL	KN	KC	KA	KK	KH	KR	KT																																																																																																											
Cermet	SV	SN	SC	SA	SK	SH	SR	ST																																																																																																											
4 Lead-in Recommendations	<table border="1"> <thead> <tr> <th></th> <th>T</th> <th>F</th> <th>N</th> <th>G</th> <th>L</th> <th>A</th> <th>V</th> <th>K</th> </tr> </thead> <tbody> <tr> <th>P</th> <td></td> <td></td> <td>●</td> <td>●</td> <td></td> <td>◐</td> <td>○</td> <td>◐</td> </tr> <tr> <th>S</th> <td>●</td> <td></td> <td></td> <td>◐</td> <td></td> <td></td> <td></td> <td></td> </tr> <tr> <th>M</th> <td></td> <td></td> <td>◐</td> <td>●</td> <td></td> <td></td> <td></td> <td>◐</td> </tr> <tr> <th>H</th> <td></td> <td></td> <td>◐</td> <td>●</td> <td></td> <td></td> <td></td> <td></td> </tr> <tr> <th>K</th> <td></td> <td></td> <td></td> <td>◐</td> <td></td> <td></td> <td>●</td> <td>◐</td> </tr> <tr> <th>N</th> <td></td> <td></td> <td></td> <td>●</td> <td></td> <td></td> <td>◐</td> <td></td> </tr> </tbody> </table>		T	F	N	G	L	A	V	K	P			●	●		◐	○	◐	S	●			◐					M			◐	●				◐	H			◐	●					K				◐			●	◐	N				●			◐		<table border="1"> <thead> <tr> <th></th> <th>E</th> <th>M</th> <th>K</th> </tr> </thead> <tbody> <tr> <th>P</th> <td>●</td> <td></td> <td>◐</td> </tr> <tr> <th>S</th> <td>●</td> <td>◐</td> <td></td> </tr> <tr> <th>M</th> <td>●</td> <td></td> <td>◐</td> </tr> <tr> <th>H</th> <td>◐</td> <td>●</td> <td></td> </tr> <tr> <th>K</th> <td>◐</td> <td>●</td> <td>◐</td> </tr> <tr> <th>N</th> <td>●</td> <td>◐</td> <td></td> </tr> </tbody> </table>		E	M	K	P	●		◐	S	●	◐		M	●		◐	H	◐	●		K	◐	●	◐	N	●	◐		<table border="1"> <thead> <tr> <th></th> <th>E</th> <th>M</th> </tr> </thead> <tbody> <tr> <th>P</th> <td>●</td> <td></td> </tr> <tr> <th>S</th> <td>●</td> <td>◐</td> </tr> <tr> <th>M</th> <td>●</td> <td></td> </tr> <tr> <th>H</th> <td>◐</td> <td>●</td> </tr> <tr> <th>K</th> <td>◐</td> <td>●</td> </tr> <tr> <th>N</th> <td>●</td> <td>◐</td> </tr> </tbody> </table>		E	M	P	●		S	●	◐	M	●		H	◐	●	K	◐	●	N	●	◐
	T	F	N	G	L	A	V	K																																																																																																											
P			●	●		◐	○	◐																																																																																																											
S	●			◐																																																																																																															
M			◐	●				◐																																																																																																											
H			◐	●																																																																																																															
K				◐			●	◐																																																																																																											
N				●			◐																																																																																																												
	E	M	K																																																																																																																
P	●		◐																																																																																																																
S	●	◐																																																																																																																	
M	●		◐																																																																																																																
H	◐	●																																																																																																																	
K	◐	●	◐																																																																																																																
N	●	◐																																																																																																																	
	E	M																																																																																																																	
P	●																																																																																																																		
S	●	◐																																																																																																																	
M	●																																																																																																																		
H	◐	●																																																																																																																	
K	◐	●																																																																																																																	
N	●	◐																																																																																																																	
5 Diameter For the diameter portion of the item number, refer to the following tables:	<table border="1"> <thead> <tr> <th colspan="2">Imperial (in)</th> <th colspan="2">Metric (mm)</th> </tr> <tr> <th>D₁ Range</th> <th>Tolerance (min/max)</th> <th>D₁ Range</th> <th>Tolerance (min/max)</th> </tr> </thead> <tbody> <tr> <td>0.4656 - 0.7086</td> <td rowspan="5">-0.0002 / +0.0002</td> <td>11.800 - 18.000</td> <td rowspan="5">-0.005 / +0.005</td> </tr> <tr> <td>0.7087 - 1.1811</td> <td>18.001 - 30.000</td> </tr> <tr> <td>1.1812 - 1.5748</td> <td>30.001 - 40.000</td> </tr> <tr> <td>1.5749 - 1.9685</td> <td>40.001 - 50.000</td> </tr> <tr> <td>1.9686 - 2.3858</td> <td>50.001 - 60.600</td> </tr> </tbody> </table>			Imperial (in)		Metric (mm)		D ₁ Range	Tolerance (min/max)	D ₁ Range	Tolerance (min/max)	0.4656 - 0.7086	-0.0002 / +0.0002	11.800 - 18.000	-0.005 / +0.005	0.7087 - 1.1811	18.001 - 30.000	1.1812 - 1.5748	30.001 - 40.000	1.5749 - 1.9685	40.001 - 50.000	1.9686 - 2.3858	50.001 - 60.600																																																																																												
Imperial (in)		Metric (mm)																																																																																																																	
D ₁ Range	Tolerance (min/max)	D ₁ Range	Tolerance (min/max)																																																																																																																
0.4656 - 0.7086	-0.0002 / +0.0002	11.800 - 18.000	-0.005 / +0.005																																																																																																																
0.7087 - 1.1811		18.001 - 30.000																																																																																																																	
1.1812 - 1.5748		30.001 - 40.000																																																																																																																	
1.5749 - 1.9685		40.001 - 50.000																																																																																																																	
1.9686 - 2.3858		50.001 - 60.600																																																																																																																	

● Best ◐ Better ○ Good

Ordering Example:

The customer needs the following:

- Straight fluted reamer head
- Expandable style
- Carbide
- TiN coating
- G lead-in
- 50.000 mm diameter

7405-KNG-50000

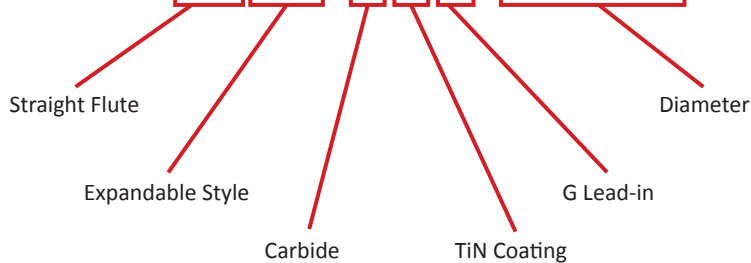

C: 60 - 71 C: 14 - 15 C: 16 - 19 C: 52 - 57 C: 72

Key on C: 1

Replaceable Head Screws

Fixed

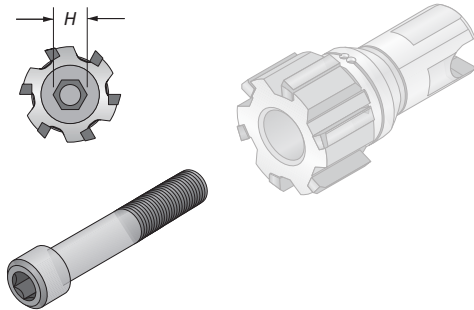

7000 Series

D_1 Range (inch)	D_1 Range (mm)	Part No.	H (mm)
0.4646 - 0.5751	11.800 - 14.609	7000-VI-001	2.5
0.5752 - 0.6932	14.610 - 17.609	7000-VI-002	3
0.6933 - 0.8507	17.610 - 21.609	7000-VI-003	4
0.8508 - 1.0475	21.610 - 26.609	7000-VI-004	5
1.0476 - 1.2838	26.610 - 32.609	7000-VI-005	6
1.2839 - 1.5987	32.610 - 40.609	7000-VI-006	6
1.5988 - 1.9924	40.610 - 50.609	7000-VI-007	8
1.9925 - 2.3858	50.610 - 60.600	7000-VI-008	10

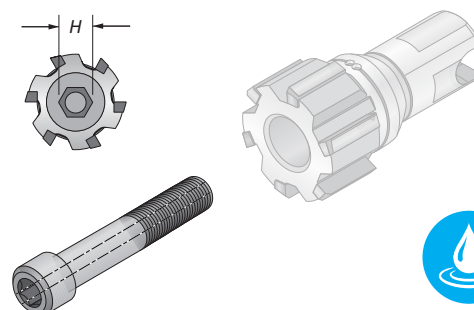

7001 Series

D_1 Range (inch)	D_1 Range (mm)	Part No.	H (mm)
0.4646 - 0.5751	11.800 - 14.609	7001-VI-001	2.5
0.5752 - 0.6932	14.610 - 17.609	7001-VI-002	3
0.6933 - 0.8507	17.610 - 21.609	7001-VI-003	4
0.8508 - 1.0475	21.610 - 26.609	7001-VI-004	5
1.0476 - 1.2838	26.610 - 32.609	7001-VI-005	6
1.2839 - 1.5987	32.610 - 40.609	7001-VI-006	6
1.5988 - 1.9924	40.610 - 50.609	7001-VI-007	8
1.9925 - 2.3858	50.610 - 60.600	7001-VI-008	10

7000 Series Locking Screws

Radial Coolant Only

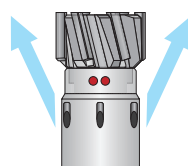

7000 Series Mandrels

No Coolant

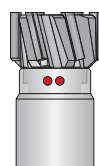

7001 Series Mandrels

7001 Series Locking Screws

Radial and Central Coolant

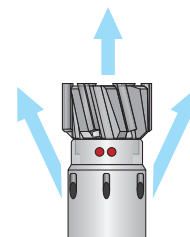

7000 Series Mandrels

Central Coolant Only

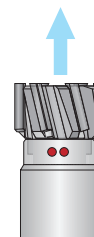

7001 Series Mandrels

C: 60 - 71

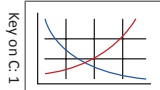

C: 12 - 13

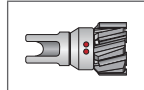

C: 16 - 19

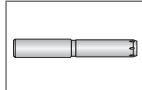

C: 52 - 57

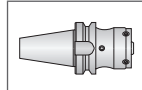

C: 72



Replaceable Head Screws

Expandable

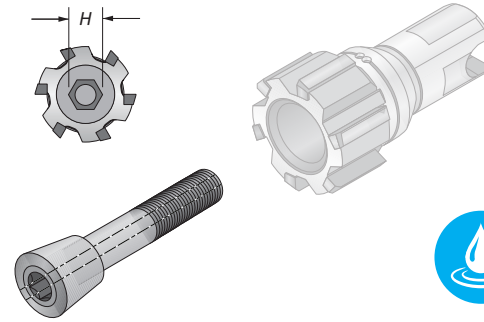
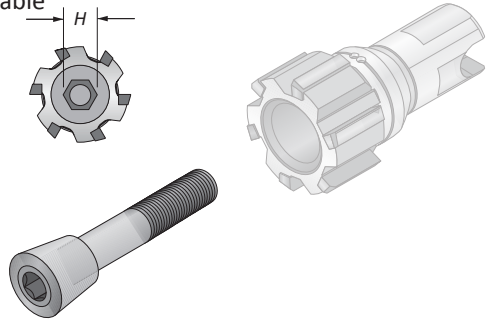

7000 Series

7001 Series

D ₁ Range (inch)	D ₁ Range (mm)	Part No.	H (mm)
0.4646 - 0.4964	11.800 - 12.609	7000-VI-012	3.5
0.4965 - 0.5357	12.610 - 13.609	7000-VI-013	3.5
0.5358 - 0.5751	13.610 - 14.609	7000-VI-014	3.5
0.5752 - 0.6145	14.610 - 15.609	7000-VI-015	4
0.6146 - 0.6538	15.610 - 16.609	7000-VI-016	4
0.6539 - 0.6932	16.610 - 17.609	7000-VI-017	4
0.6933 - 0.7326	17.610 - 18.609	7000-VI-018	5
0.7327 - 0.7719	18.610 - 19.609	7000-VI-019	5
0.7720 - 0.8113	19.610 - 20.609	7000-VI-020	5
0.8114 - 0.8507	20.610 - 21.609	7000-VI-021	5
0.8508 - 0.8901	21.610 - 22.609	7000-VI-022	6
0.8902 - 0.9294	22.610 - 23.609	7000-VI-023	6
0.9295 - 0.9688	23.610 - 24.609	7000-VI-024	6
0.9689 - 1.0082	24.610 - 25.609	7000-VI-025	6
1.0083 - 1.0475	25.610 - 26.609	7000-VI-026	6
1.0476 - 1.0869	26.610 - 27.609	7000-VI-027	8
1.0870 - 1.1263	27.610 - 28.609	7000-VI-028	8
1.1264 - 1.1656	28.610 - 29.609	7000-VI-029	8
1.1657 - 1.2050	29.610 - 30.609	7000-VI-030	8
1.2051 - 1.2444	30.610 - 31.609	7000-VI-031	8
1.2445 - 1.2838	31.610 - 32.609	7000-VI-032	8
1.2839 - 1.3231	32.610 - 33.609	7000-VI-033	8
1.3232 - 1.3625	33.610 - 34.609	7000-VI-034	10
1.3626 - 1.4019	34.610 - 35.609	7000-VI-035	10
1.4020 - 1.4412	35.610 - 36.609	7000-VI-036	10
1.4413 - 1.4806	36.610 - 37.609	7000-VI-037	10
1.4807 - 1.5200	37.610 - 38.609	7000-VI-038	10
1.5201 - 1.5593	38.610 - 39.609	7000-VI-039	10
1.5594 - 1.5987	39.610 - 40.609	7000-VI-040	10
1.5988 - 1.6381	40.610 - 41.609	7000-VI-041	12
1.6382 - 1.6775	41.610 - 42.609	7000-VI-042	12
1.6776 - 1.7168	42.610 - 43.609	7000-VI-043	12
1.7169 - 1.7562	43.610 - 44.609	7000-VI-044	12
1.7563 - 1.7956	44.610 - 45.609	7000-VI-045	12
1.7957 - 1.8349	45.610 - 46.609	7000-VI-046	12
1.8350 - 1.8743	46.610 - 47.609	7000-VI-047	12
1.8744 - 1.9137	47.610 - 48.609	7000-VI-048	12
1.9138 - 1.9530	48.610 - 49.609	7000-VI-049	12
1.9531 - 1.9924	49.610 - 50.609	7000-VI-050	12
1.9925 - 2.0318	50.610 - 51.609	7000-VI-051	12
2.0319 - 2.0712	51.610 - 52.609	7000-VI-052	12
2.0713 - 2.1105	52.610 - 53.609	7000-VI-053	12
2.1106 - 2.1499	53.610 - 54.609	7000-VI-054	12
2.1500 - 2.1893	54.610 - 55.609	7000-VI-055	12
2.1894 - 2.2286	55.610 - 56.609	7000-VI-056	12
2.2287 - 2.2680	56.610 - 57.609	7000-VI-057	12
2.2681 - 2.3074	57.610 - 58.609	7000-VI-058	12
2.3075 - 2.3468	58.610 - 59.609	7000-VI-059	12
2.3469 - 2.3858	59.610 - 60.609	7000-VI-060	12

D ₁ Range (inch)	D ₁ Range (mm)	Part No.	H (mm)
0.4646 - 0.4964	11.800 - 12.609	7001-VI-012	3.5
0.4965 - 0.5357	12.610 - 13.609	7001-VI-013	3.5
0.5358 - 0.5751	13.610 - 14.609	7001-VI-014	3.5
0.5752 - 0.6145	14.610 - 15.609	7001-VI-015	4
0.6146 - 0.6538	15.610 - 16.609	7001-VI-016	4
0.6539 - 0.6932	16.610 - 17.609	7001-VI-017	4
0.6933 - 0.7326	17.610 - 18.609	7001-VI-018	5
0.7327 - 0.7719	18.610 - 19.609	7001-VI-019	5
0.7720 - 0.8113	19.610 - 20.609	7001-VI-020	5
0.8114 - 0.8507	20.610 - 21.609	7001-VI-021	5
0.8508 - 0.8901	21.610 - 22.609	7001-VI-022	6
0.8902 - 0.9294	22.610 - 23.609	7001-VI-023	6
0.9295 - 0.9688	23.610 - 24.609	7001-VI-024	6
0.9689 - 1.0082	24.610 - 25.609	7001-VI-025	6
1.0083 - 1.0475	25.610 - 26.609	7001-VI-026	6
1.0476 - 1.0869	26.610 - 27.609	7001-VI-027	8
1.0870 - 1.1263	27.610 - 28.609	7001-VI-028	8
1.1264 - 1.1656	28.610 - 29.609	7001-VI-029	8
1.1657 - 1.2050	29.610 - 30.609	7001-VI-030	8
1.2051 - 1.2444	30.610 - 31.609	7001-VI-031	8
1.2445 - 1.2838	31.610 - 32.609	7001-VI-032	8
1.2839 - 1.3231	32.610 - 33.609	7001-VI-033	8
1.3232 - 1.3625	33.610 - 34.609	7001-VI-034	10
1.3626 - 1.4019	34.610 - 35.609	7001-VI-035	10
1.4020 - 1.4412	35.610 - 36.609	7001-VI-036	10
1.4413 - 1.4806	36.610 - 37.609	7001-VI-037	10
1.4807 - 1.5200	37.610 - 38.609	7001-VI-038	10
1.5201 - 1.5593	38.610 - 39.609	7001-VI-039	10
1.5594 - 1.5987	39.610 - 40.609	7001-VI-040	10
1.5988 - 1.6381	40.610 - 41.609	7001-VI-041	12
1.6382 - 1.6775	41.610 - 42.609	7001-VI-042	12
1.6776 - 1.7168	42.610 - 43.609	7001-VI-043	12
1.7169 - 1.7562	43.610 - 44.609	7001-VI-044	12
1.7563 - 1.7956	44.610 - 45.609	7001-VI-045	12
1.7957 - 1.8349	45.610 - 46.609	7001-VI-046	12
1.8350 - 1.8743	46.610 - 47.609	7001-VI-047	12
1.8744 - 1.9137	47.610 - 48.609	7001-VI-048	12
1.9138 - 1.9530	48.610 - 49.609	7001-VI-049	12
1.9531 - 1.9924	49.610 - 50.609	7001-VI-050	12
1.9925 - 2.0318	50.610 - 51.609	7001-VI-051	12
2.0319 - 2.0712	51.610 - 52.609	7001-VI-052	12
2.0713 - 2.1105	52.610 - 53.609	7001-VI-053	12
2.1106 - 2.1499	53.610 - 54.609	7001-VI-054	12
2.1500 - 2.1893	54.610 - 55.609	7001-VI-055	12
2.1894 - 2.2286	55.610 - 56.609	7001-VI-056	12
2.2287 - 2.2680	56.610 - 57.609	7001-VI-057	12
2.2681 - 2.3074	57.610 - 58.609	7001-VI-058	12
2.3075 - 2.3468	58.610 - 59.609	7001-VI-059	12
2.3469 - 2.3858	59.610 - 60.609	7001-VI-060	12

C: 60 - 71 C: 12 - 13 C: 16 - 19 C: 52 - 57 C: 72

Replaceable Head Mandrels

Short Length | Cylindrical Shank | Diameter Range: 0.4646" - 2.3858" (11.80 mm - 60.60 mm)

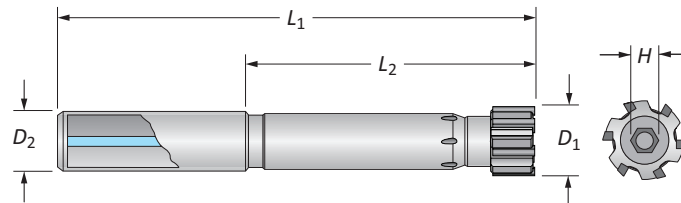
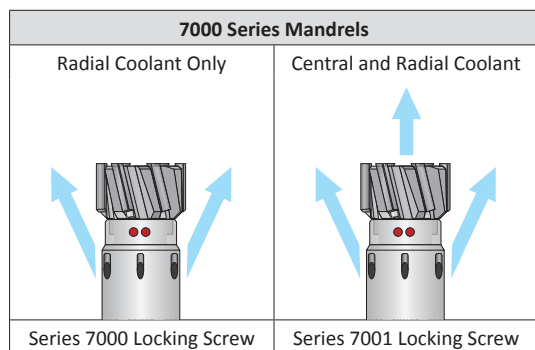

D_1 Range		Mandrel			No. of Teeth	Part No.
Imperial (in)	Metric (mm)	L_2 (mm)	L_1 (mm)	D_2 (mm)		
0.4646 - 0.5751	11.800 - 14.609	50	95	12	6	7000-MC-001
0.5752 - 0.6932	14.610 - 17.609	65	113	16	6	7000-MC-002
0.6933 - 0.8507	17.610 - 21.609	75	125	20	6	7000-MC-003
0.8508 - 1.0475	21.610 - 26.609	85	135	20	6	7000-MC-004
1.0476 - 1.2838	26.610 - 32.609	105	161	25	6	7000-MC-005
1.2839 - 1.5987	32.610 - 40.609	120	180	32	6	7000-MC-006
1.5988 - 1.7956	40.610 - 45.600	120	180	32	6	7000-MC-007
1.7957 - 1.9924	45.610 - 50.600	120	180	32	8	7000-MC-075
1.9925 - 2.3858	50.610 - 60.600	120	190	32	8	7000-MC-008

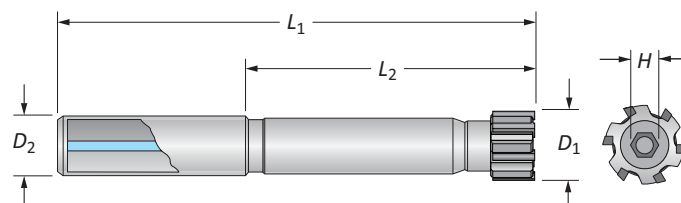
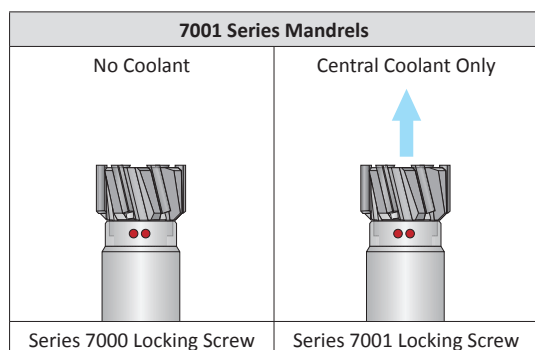

D_1 Range		Mandrel			No. of Teeth	Part No.
Imperial (in)	Metric (mm)	L_2 (mm)	L_1 (mm)	D_2 (mm)		
0.4646 - 0.5751	11.800 - 14.609	50	95	12	6	7001-MC-001
0.5752 - 0.6932	14.610 - 17.609	65	113	16	6	7001-MC-002
0.6933 - 0.8507	17.610 - 21.609	75	125	20	6	7001-MC-003
0.8508 - 1.0475	21.610 - 26.609	85	135	20	6	7001-MC-004
1.0476 - 1.2838	26.610 - 32.609	105	161	25	6	7001-MC-005
1.2839 - 1.5987	32.610 - 40.609	120	180	32	6	7001-MC-006
1.5988 - 1.7956	40.610 - 45.600	120	180	32	6	7001-MC-007
1.7957 - 1.9924	45.610 - 50.600	120	180	32	8	7001-MC-075
1.9925 - 2.3858	50.610 - 60.600	120	190	32	8	7001-MC-008

C: 60 - 71

C: 12 - 13

C: 16 - 19

C: 52 - 57

C: 72

Key on C: 1

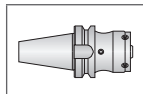
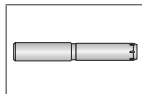
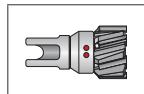
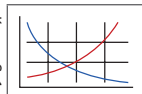

Application recommendation:

- Through hole application = radial coolant
- Blind hole application = central coolant



Replaceable Head Mandrels

Long Length | Cylindrical Shank | Diameter Range: 0.4646" - 2.3858" (11.80 mm - 60.60 mm)

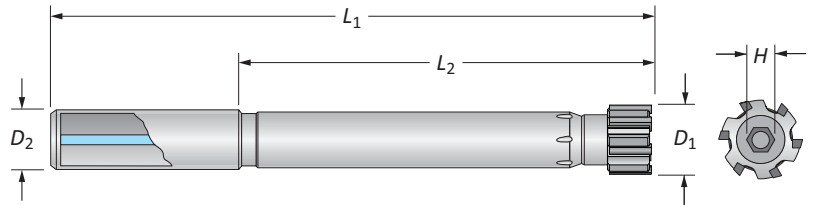
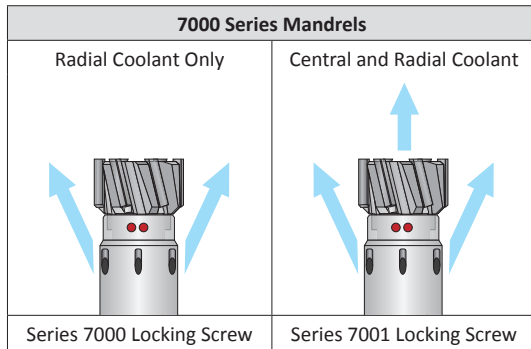

D ₁ Range		Mandrel			No. of Teeth	Part No.
Imperial (in)	Metric (mm)	L ₂ (mm)	L ₁ (mm)	D ₂ (mm)		
0.4646 - 0.5751	11.800 - 14.609	95	140	12	6	7000-ML-001
0.5752 - 0.6932	14.610 - 17.609	105	153	16	6	7000-ML-002
0.6933 - 0.8507	17.610 - 21.609	125	175	20	6	7000-ML-003
0.8508 - 1.0475	21.610 - 26.609	145	195	20	6	7000-ML-004
1.0476 - 1.2838	26.610 - 32.609	165	221	25	6	7000-ML-005
1.2839 - 1.5987	32.610 - 40.609	185	245	32	6	7000-ML-006
1.5988 - 1.7956	40.610 - 45.600	185	245	32	6	7000-ML-007
1.7957 - 1.9924	45.610 - 50.600	185	245	32	8	7000-ML-075
1.9925 - 2.3858	50.610 - 60.600	185	255	32	8	7000-ML-008

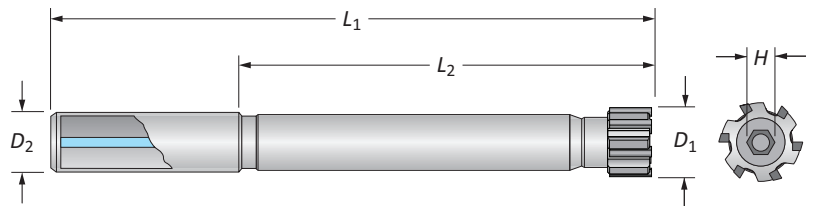
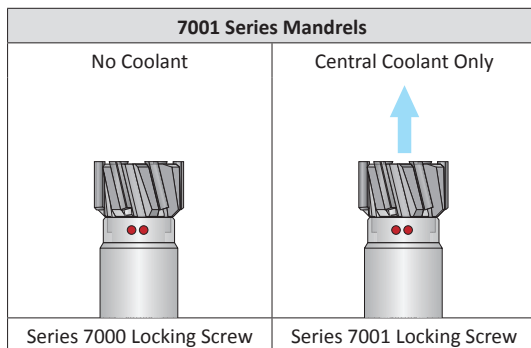

D ₁ Range		Mandrel			No. of Teeth	Part No.
Imperial (in)	Metric (mm)	L ₂ (mm)	L ₁ (mm)	D ₂ (mm)		
0.4646 - 0.5751	11.800 - 14.609	95	140	12	6	7001-ML-001
0.5752 - 0.6932	14.610 - 17.609	105	153	16	6	7001-ML-002
0.6933 - 0.8507	17.610 - 21.609	125	175	20	6	7001-ML-003
0.8508 - 1.0475	21.610 - 26.609	145	195	20	6	7001-ML-004
1.0476 - 1.2838	26.610 - 32.609	165	221	25	6	7001-ML-005
1.2839 - 1.5987	32.610 - 40.609	185	245	32	6	7001-ML-006
1.5988 - 1.7956	40.610 - 45.600	185	245	32	6	7001-ML-007
1.7957 - 1.9924	45.610 - 50.600	185	245	32	8	7001-ML-075
1.9925 - 2.3858	50.610 - 60.600	185	255	32	8	7001-ML-008

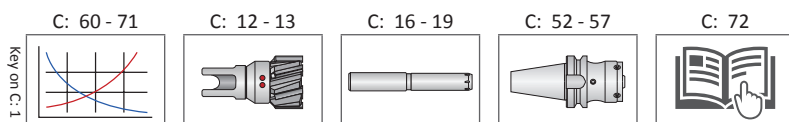

Application recommendation:

- Through hole application = radial coolant
- Blind hole application = central coolant

Replaceable Head Mandrels

Standard Length | Modular Shank | Diameter Range: 0.4646" - 2.3858" (11.80 mm - 60.60 mm)

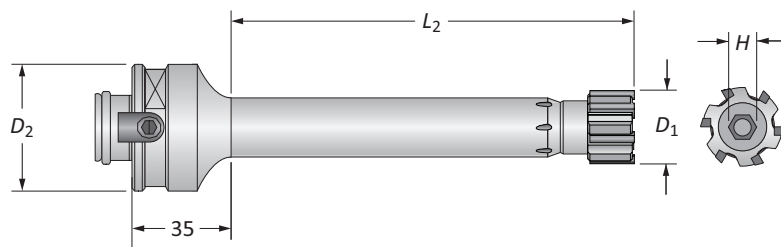
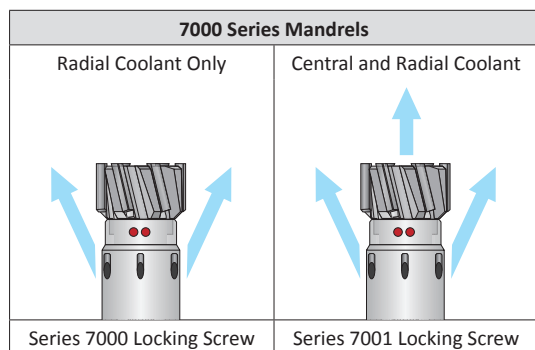

D ₁ Range		Mandrel		No. of Teeth	Part No.
Imperial (in)	Metric (mm)	L ₂ (mm)	D ₂ (mm)		
0.4646 - 0.5751	11.800 - 14.609	65	50	6	7000-MM-001
0.5752 - 0.6932	14.610 - 17.609	80	50	6	7000-MM-002
0.6933 - 0.8507	17.610 - 21.609	90	50	6	7000-MM-003
0.8508 - 1.0475	21.610 - 26.609	100	50	6	7000-MM-004
1.0476 - 1.2838	26.610 - 32.609	110	50	6	7000-MM-005
1.2839 - 1.5987	32.610 - 40.609	120	50	6	7000-MM-006
1.5988 - 1.7956	40.610 - 45.600	120	50	6	7000-MM-007
1.7957 - 1.9924	45.610 - 50.600	120	50	8	7000-MM-075
1.9925 - 2.3858	50.610 - 60.600	120	50	8	7000-MM-008

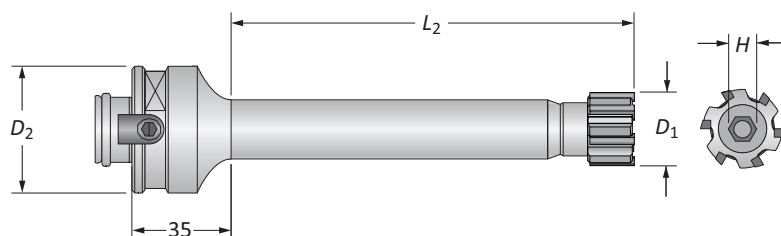
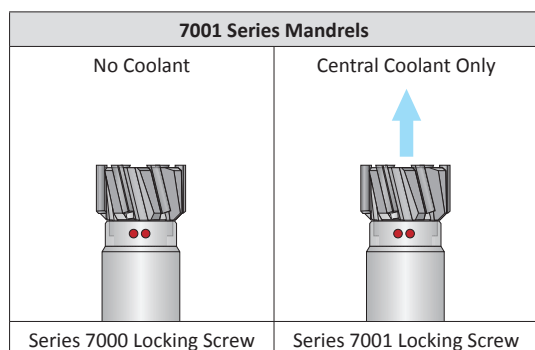

D ₁ Range		Mandrel		No. of Teeth	Part No.
Imperial (in)	Metric (mm)	L ₂ (mm)	D ₂ (mm)		
0.4646 - 0.5751	11.800 - 14.609	65	50	6	7001-MM-001
0.5752 - 0.6932	14.610 - 17.609	80	50	6	7001-MM-002
0.6933 - 0.8507	17.610 - 21.609	90	50	6	7001-MM-003
0.8508 - 1.0475	21.610 - 26.609	100	50	6	7001-MM-004
1.0476 - 1.2838	26.610 - 32.609	110	50	6	7001-MM-005
1.2839 - 1.5987	32.610 - 40.609	120	50	6	7001-MM-006
1.5988 - 1.7956	40.610 - 45.600	120	50	6	7001-MM-007
1.7957 - 1.9924	45.610 - 50.600	120	50	8	7001-MM-075
1.9925 - 2.3858	50.610 - 60.600	120	50	8	7001-MM-008

C: 60 - 71

C: 12 - 13

C: 16 - 19

C: 52 - 57

C: 72

Key on C: 1

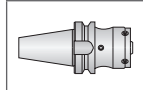
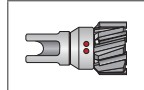
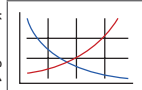

Application recommendation:

- Through hole application = radial coolant
- Blind hole application = central coolant



Replaceable Head Mandrels

AR Upper Receiver | Cylindrical Shank | Diameter Range: 1.0000" - 1.1875" (25.40 mm - 30.16 mm)

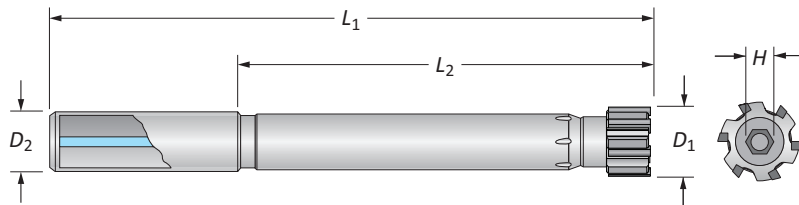
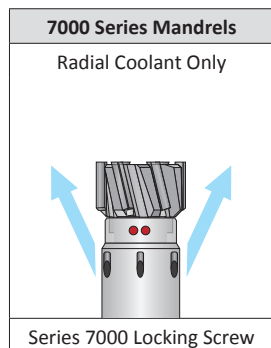

D_1		Mandrel			No. of Teeth	Part No.
Imperial (in)	Metric (mm)	L_2 (in)	L_1 (in)	D_2 (in)		
1.1875	30.16	9.65	11.65	0.750	6	7000-MC-AR10
1.0000	25.40	8.66	10.63	0.750	6	7000-MC-AR15

Achieve the **long length of cut** and **surface finish** you need.



CASE STUDY | AR15 Upper Receiver

Material: 6061 T6 Aluminum

Measure	Carbide-Tipped Chucking Reamer	ALVAN® Replaceable Head Reamer
RPM	1146	2559
Speed	300 SFM	670 SFM
Feed In	0.018 IPR (20.6 IPM)	0.045 IPR (115 IPM)
Feed Out	0.018 IPR (20.6 IPM)	0.090 IPR (230.3 IPM)
Finish	63 Ra	32 Ra
Follow-Up Process	Roller Burnish	None
Cycle Time	0:00:55	0:00:09
Cost Per Hole	\$0.77	\$0.26
Total Parts	3,500	3,500
Total Cost	\$2,691.18	\$933.84

SURFACE FINISH $\sqrt{32}$ Ra
no burnishing required

123% ↑ SPEED

150% ↑ FEED

84% ↓ CYCLE TIME

65% ↓ TOTAL COSTS

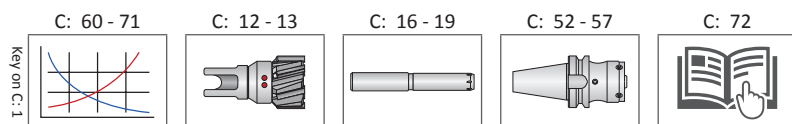

Application recommendation:

- Through hole application = radial coolant
- Blind hole application = central coolant

Monobloc Style Reamers

Product Overview

Monobloc Reamer Features

- Diameter range: 0.2283" - 1.2638" (5.80 mm - 32.10 mm)
- Available with straight or left-hand helical flutes
- Expandable up to 1% of nominal diameter
- Available with cylindrical shanks only
- Work day lead time 15 - 25 days (quantity dependent)
- Available for recondition

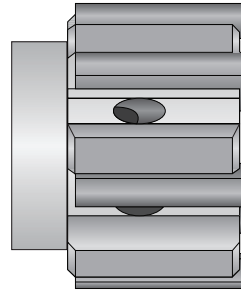

Straight Flute

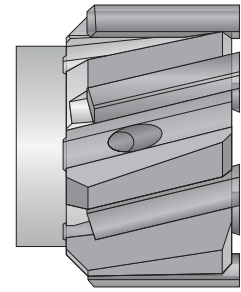

Left-Hand Helical Flute

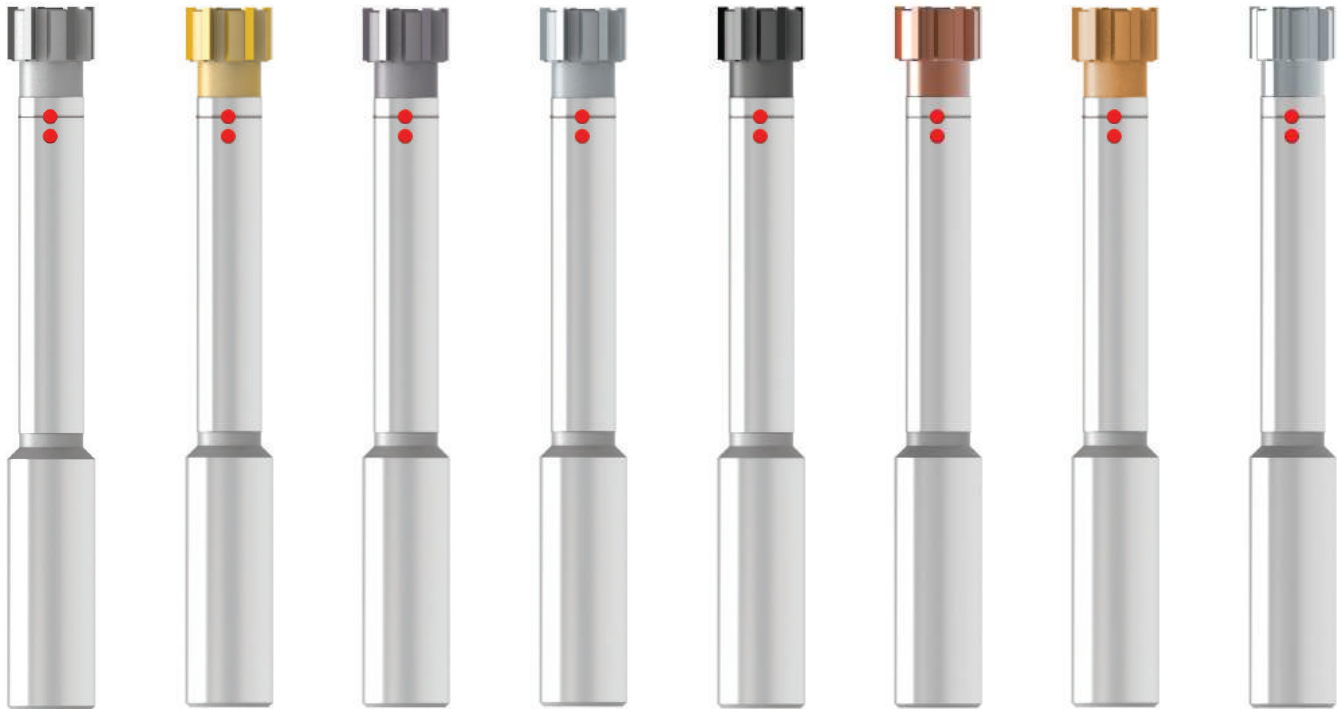

Uncoated

TiN Coated

TiAlN Coated

TiCN Coated

Alcrona Coated

Hardcut Coated

R Coated

T Coated

Straight Flute - Through or Blind Holes

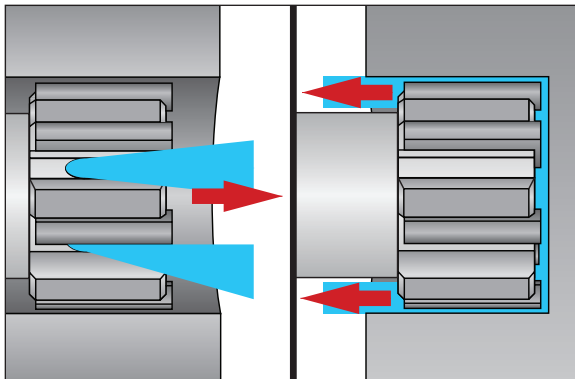

Use for either through hole or blind hole applications. The coolant flow determines the direction of the chip evacuation.

Left-Hand Helical Flute - Through Holes Only

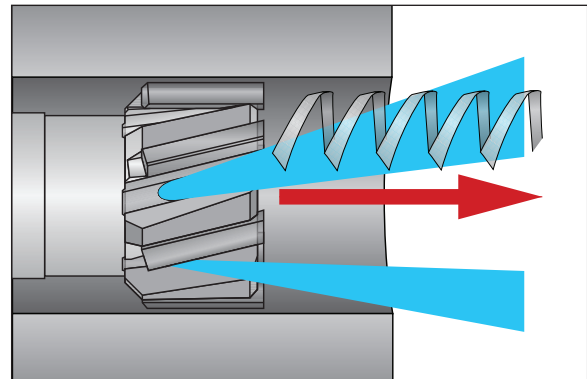

Use when reaming through hole applications. The cutting action of the helical flutes forces the chips forward for evacuation.

Product Nomenclature

Monobloc Style Reamers

I	9	3627	-	KL	E	-	006250	+	0000	-	0005
1	2	3		4	5		6		7		

NOTE: If diameter and tolerance are specified in inch units, put an "I" at the beginning of the item number

<p>1. Diameter Unit of Measure</p> <p>Blank = Metric diameter (mm) I = Imperial diameter (in)</p>	<p>2. Shank Measure</p> <p>Blank = Metric 9 = Inch</p>	<p>3. Series</p> <p>2441 = Short length, straight flute - central coolant (blind holes) 3620 = Short length, straight flute - radial coolant (through holes) 3627 = Short length, helical flute - radial coolant (through holes)</p> <p>2431 = Long length, straight flute - central coolant (blind holes) 3610 = Long length, straight flute - radial coolant (through holes) 3617 = Long length, helical flute - radial coolant (through holes)</p>
<p>4. Coating and Substrate</p> <p>KL = Uncoated carbide SV = Uncoated cermet KN = TiN coated carbide SN = TiN coated cermet KC = TiCN coated carbide SC = TiCN coated cermet KA = TiAlN coated carbide SA = TiAlN coated cermet KK = Alcrona coated carbide SK = Alcrona coated cermet KH = Hardcut coated carbide KH = Hardcut coated cermet KR = R coated carbide KR = R coated cermet KT = T coated carbide KT = T coated cermet</p>	<p>5. Lead-in</p> <p>E, M = Left-hand helical flute A, F, G, L, N, T, V, K = Straight flute K = Chipbreaker geometry for straight or helical flute</p>	
<p>6. Diameter</p> <p>XX.XXXX = Imperial (inch) XXX.XXX = Metric (mm)</p>	<p>7. Tolerance*</p> <p>4 decimal places = inch tolerance 3 decimal places = mm tolerance</p> <p>*The total tolerance capable is 0.0002" (0.005 mm)</p>	

Reference Key

Symbol	Attribute
D_1	Reamer diameter
D_2	Shank diameter
L_1	Overall length
L_2	Body length
L_{15}	Cutting edge length
H	Hex key

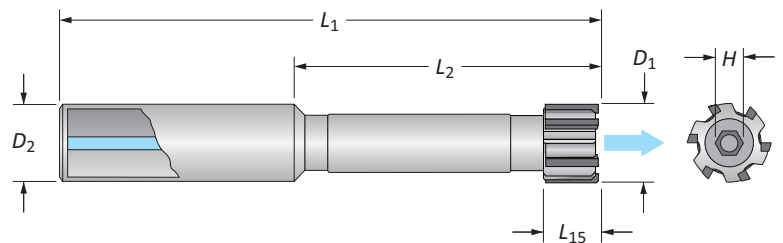

Monobloc Reamers

2441 Series | Short Length | Diameter Range: 0.2283" - 1.2638" (5.80 mm - 32.10 mm)

Series	2441
Flute	Straight
Type	Blind Holes
Coolant	Central

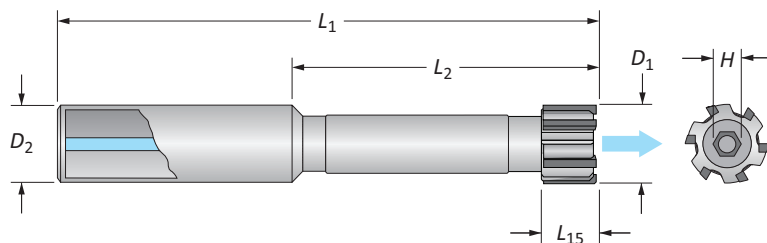

Inch Shank Part No. 92441-CGL-D ₁					Metric Shank Part No. 2441-CGL-D ₁					No. of Teeth	H (mm)
D ₁ Range	L ₁₅	L ₂	L ₁	D ₂	D ₁ Range	L ₁₅	L ₂	L ₁	D ₂		
0.2283 - 0.2598	0.315	1.575	3.071	0.500	5.80 - 6.60	8	40	80	12	4	1.5
0.2599 - 0.2992	0.315	1.575	3.071	0.500	6.61 - 7.60	8	40	80	12	4	2
0.2993 - 0.3386	0.394	1.575	3.071	0.500	7.61 - 8.60	10	40	80	12	4	2.5
0.3387 - 0.3780	0.394	1.969	3.465	0.500	8.61 - 9.60	10	50	90	12	4	2.5
0.3781 - 0.4173	0.394	1.969	3.740	0.500	9.61 - 10.60	10	50	95	12	6	3
0.4174 - 0.4567	0.394	1.969	3.740	0.500	10.61 - 11.60	10	60	105	12	6	3
0.4568 - 0.4961	0.394	1.969	3.740	0.500	11.61 - 12.60	10	60	105	12	6	3
0.4962 - 0.5354	0.394	1.969	3.740	0.500	12.61 - 13.60	10	60	105	12	6	4
0.5355 - 0.5748	0.394	1.969	3.740	0.500	13.61 - 14.60	10	70	115	12	6	4
0.5749 - 0.6142	0.394	1.969	3.740	0.500	14.61 - 15.60	10	70	115	12	6	4
0.6143 - 0.6535	0.394	1.969	3.937	0.625	15.61 - 16.60	10	80	130	16	6	4
0.6536 - 0.6929	0.394	1.969	3.937	0.625	16.61 - 17.60	10	80	130	16	6	5
0.6930 - 0.7323	0.472	1.969	3.937	0.625	17.61 - 18.60	12	90	140	16	6	5
0.7324 - 0.7520	0.472	2.362	4.724	0.750	18.61 - 19.10	12	90	150	20	6	5
0.7521 - 0.7913	0.472	2.362	4.724	0.750	19.11 - 20.10	12	100	160	20	6	5
0.7914 - 0.8307	0.472	2.362	4.724	0.750	20.11 - 21.10	12	100	160	20	6	5
0.8308 - 0.8701	0.472	2.362	4.724	0.750	21.11 - 22.10	12	100	160	20	6	6
0.8702 - 0.9094	0.472	2.362	4.724	0.750	22.11 - 23.10	12	100	160	20	6	6
0.9095 - 0.9488	0.472	2.362	4.724	0.750	23.11 - 24.10	12	100	160	20	6	6
0.9489 - 0.9882	0.472	2.362	4.724	0.750	24.11 - 25.10	12	100	160	20	6	6
0.9883 - 1.0276	0.472	2.953	5.315	1.000	25.11 - 26.10	16	110	170	25	6	6
1.0277 - 1.0669	0.551	2.953	5.315	1.000	26.11 - 27.10	16	110	170	25	6	6
1.0670 - 1.1063	0.551	2.953	5.315	1.000	27.11 - 28.10	16	110	170	25	6	8
1.1064 - 1.1457	0.551	2.953	5.315	1.000	28.11 - 29.10	16	110	170	25	6	8
1.1458 - 1.1850	0.551	2.953	5.315	1.000	29.11 - 30.10	16	110	170	25	6	8
1.1851 - 1.2244	0.551	2.953	5.315	1.000	30.11 - 31.10	16	110	170	25	6	8
1.2245 - 1.2638	0.551	2.953	5.315	1.000	31.11 - 32.10	16	110	170	25	6	8

"CG" Portion of Item No. (Coating and Substrate Code)

Grade	Uncoated	TiN	TiCN	TiAlN	Alcrona	Hardcut	R Coating	T Coating
Carbide	KL	KN	KC	KA	KK	KH	KR	KT
Cermet	SV	SN	SC	SA	SK	SH	SR	ST

"L" Portion of Item No. (Lead-in Recommendation)

ISO Material	T	F	N	G	L	A	V	K
P			●	●		○	○	○
S	●			○				
M			○	●				○
H			○	●				
K				○			●	○
N				●			○	

● Best ○ Better ○ Good

Ordering Example:
The customer needs the following:

- Metric shank
- Carbide
- TiN coating
- F lead-in
- 30.60 mm diameter
- Blind hole

2441-KNF-030600

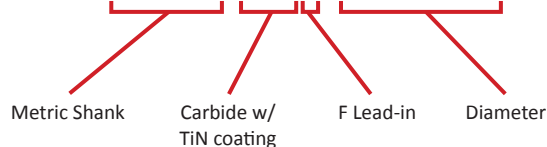

Key on C: 1

C: 60 - 71

C: 52 - 59

C: 72



Monobloc Reamers

3620 Series | Short Length | Diameter Range: 0.2283" - 1.2638" (5.80 mm - 32.10 mm)

Series	3620
Flute	Straight
Type	Through Holes
Coolant	Radial

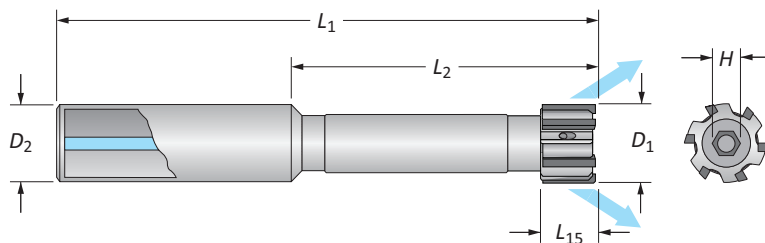

Inch Shank Part No. 93620-CGL-D ₁					Metric Shank Part No. 3620-CGL-D ₁					No. of Teeth	H (mm)
D ₁ Range	L ₁₅	L ₂	L ₁	D ₂	D ₁ Range	L ₁₅	L ₂	L ₁	D ₂		
0.2283 - 0.2598	0.315	1.575	3.071	0.500	5.80 - 6.60	8	40	78	12	4	1.5
0.2599 - 0.2992	0.315	1.575	3.071	0.500	6.61 - 7.60	8	40	78	12	4	2
0.2993 - 0.3386	0.394	1.575	3.071	0.500	7.61 - 8.60	10	40	78	12	4	2.5
0.3387 - 0.3780	0.394	1.969	3.465	0.500	8.61 - 9.60	10	50	88	12	4	2.5
0.3781 - 0.4173	0.394	1.969	3.740	0.500	9.61 - 10.60	10	50	95	12	6	3
0.4174 - 0.4567	0.394	1.969	3.740	0.500	10.61 - 11.60	10	50	95	12	6	3
0.4568 - 0.4961	0.394	1.969	3.740	0.500	11.61 - 12.60	10	50	95	12	6	3
0.4962 - 0.5354	0.394	1.969	3.740	0.500	12.61 - 13.60	10	50	95	12	6	4
0.5355 - 0.5748	0.394	1.969	3.740	0.500	13.61 - 14.60	10	50	95	12	6	4
0.5749 - 0.6142	0.394	1.969	3.740	0.500	14.61 - 15.60	10	50	95	12	6	4
0.6143 - 0.6535	0.394	1.969	3.937	0.625	15.61 - 16.60	10	50	100	16	6	4
0.6536 - 0.6929	0.394	1.969	3.937	0.625	16.61 - 17.60	10	50	100	16	6	5
0.6930 - 0.7323	0.472	1.969	3.937	0.625	17.61 - 18.60	12	50	100	16	6	5
0.7324 - 0.7520	0.472	2.362	4.724	0.750	18.61 - 19.10	12	60	120	20	6	5
0.7521 - 0.7913	0.472	2.362	4.724	0.750	19.11 - 20.10	12	60	120	20	6	5
0.7914 - 0.8307	0.472	2.362	4.724	0.750	20.11 - 21.10	12	60	120	20	6	5
0.8308 - 0.8701	0.472	2.362	4.724	0.750	21.11 - 22.10	12	60	120	20	6	6
0.8702 - 0.9094	0.472	2.362	4.724	0.750	22.11 - 23.10	12	60	120	20	6	6
0.9095 - 0.9488	0.472	2.362	4.724	0.750	23.11 - 24.10	12	60	120	20	6	6
0.9489 - 0.9882	0.472	2.362	4.724	0.750	24.11 - 25.10	12	60	120	20	6	6
0.9883 - 1.0276	0.472	2.953	5.315	1.000	25.11 - 26.10	16	70	135	25	6	6
1.0277 - 1.0669	0.551	2.953	5.315	1.000	26.11 - 27.10	16	70	135	25	6	6
1.0670 - 1.1063	0.551	2.953	5.315	1.000	27.11 - 28.10	16	70	135	25	6	8
1.1064 - 1.1457	0.551	2.953	5.315	1.000	28.11 - 29.10	16	70	135	25	6	8
1.1458 - 1.1850	0.551	2.953	5.315	1.000	29.11 - 30.10	16	70	135	25	6	8
1.1851 - 1.2244	0.551	2.953	5.315	1.000	30.11 - 31.10	16	70	135	25	6	8
1.2245 - 1.2638	0.551	2.953	5.315	1.000	31.11 - 32.10	16	70	135	25	6	8

"CG" Portion of Item No. (Coating and Substrate Code)

Grade	Uncoated	TiN	TiCN	TiAlN	Alcrona	Hardcut	R Coating	T Coating
Carbide	KL	KN	KC	KA	KK	KH	KR	KT
Cermet	SV	SN	SC	SA	SK	SH	SR	ST

"L" Portion of Item No. (Lead-in Recommendation)

ISO Material	T	F	N	G	L	A	V	K
P			●	●		○	○	○
S	●			○				
M			○	●				○
H			○	●				
K				○			●	○
N				●			○	

● Best ○ Better ○ Good

Ordering Example:

The customer needs the following:

- Metric shank
- Carbide
- TiN coating
- F lead-in
- 30.60 mm diameter
- Through hole

3620-KNF-030600

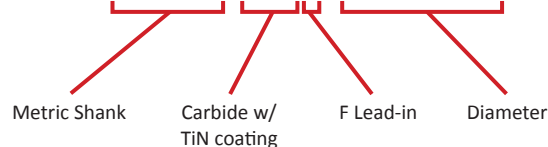

Key on C-1

C: 60 - 71

C: 52 - 59

C: 72

Monobloc Reamers

3627 Series | Short Length | Diameter Range: 0.2283" - 1.2638" (5.80 mm - 32.10 mm)

Series	3627
Flute	Helical
Type	Through Holes
Coolant	Radial

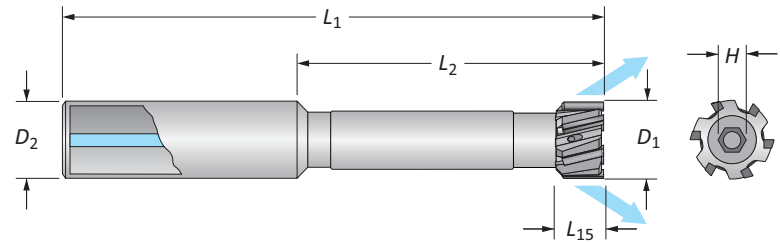

Inch Shank Part No. 93627-CGL-D ₁					Metric Shank Part No. 3627-CGL-D ₁					No. of Teeth	H (mm)
D ₁ Range	L ₁₅	L ₂	L ₁	D ₂	D ₁ Range	L ₁₅	L ₂	L ₁	D ₂		
0.2283 - 0.2598	0.315	1.575	3.150	0.500	5.80 - 6.60	8	40	80	12	4	1.5
0.2599 - 0.2992	0.315	1.575	3.150	0.500	6.61 - 7.60	8	40	80	12	4	2
0.2993 - 0.3386	0.394	1.575	3.150	0.500	7.61 - 8.60	10	40	80	12	4	2.5
0.3387 - 0.3780	0.394	1.969	3.543	0.500	8.61 - 9.60	10	50	90	12	4	2.5
0.3781 - 0.4173	0.394	1.969	3.740	0.500	9.61 - 10.60	10	50	95	12	6	3
0.4174 - 0.4567	0.394	2.362	4.134	0.500	10.61 - 11.60	10	60	105	12	6	3
0.4568 - 0.4961	0.394	2.362	4.134	0.500	11.61 - 12.60	10	60	105	12	6	3
0.4962 - 0.5354	0.394	2.362	4.134	0.500	12.61 - 13.60	10	60	105	12	6	4
0.5355 - 0.5748	0.394	2.756	4.528	0.500	13.61 - 14.60	10	70	115	12	6	4
0.5749 - 0.6142	0.394	2.756	4.528	0.500	14.61 - 15.60	10	70	115	12	6	4
0.6143 - 0.6535	0.394	3.150	5.118	0.625	15.61 - 16.60	10	80	130	16	6	4
0.6536 - 0.6929	0.394	3.150	5.118	0.625	16.61 - 17.60	10	80	130	16	6	5
0.6930 - 0.7323	0.472	3.543	5.512	0.625	17.61 - 18.60	12	90	140	16	6	5
0.7324 - 0.7520	0.472	3.543	5.906	0.750	18.61 - 19.10	12	90	150	20	6	5
0.7521 - 0.7913	0.472	3.937	6.299	0.750	19.11 - 20.10	12	100	160	20	6	5
0.7914 - 0.8307	0.472	3.937	6.299	0.750	20.11 - 21.10	12	100	160	20	6	5
0.8308 - 0.8701	0.472	3.937	6.299	0.750	21.11 - 22.10	12	100	160	20	6	6
0.8702 - 0.9094	0.472	3.937	6.299	0.750	22.11 - 23.10	12	100	160	20	6	6
0.9095 - 0.9488	0.472	3.937	6.299	0.750	23.11 - 24.10	12	100	160	20	6	6
0.9489 - 0.9882	0.472	3.937	6.299	0.750	24.11 - 25.10	12	100	160	20	6	6
0.9883 - 1.0276	0.472	4.331	6.693	1.000	25.11 - 26.10	16	110	170	25	6	6
1.0277 - 1.0669	0.551	4.331	6.693	1.000	26.11 - 27.10	16	110	170	25	6	6
1.0670 - 1.1063	0.551	4.331	6.693	1.000	27.11 - 28.10	16	110	170	25	6	8
1.1064 - 1.1457	0.551	4.331	6.693	1.000	28.11 - 29.10	16	110	170	25	6	8
1.1458 - 1.1850	0.551	4.331	6.693	1.000	29.11 - 30.10	16	110	170	25	6	8
1.1851 - 1.2244	0.551	4.331	6.693	1.000	30.11 - 31.10	16	110	170	25	6	8
1.2245 - 1.2638	0.551	4.331	6.693	1.000	31.11 - 32.10	16	110	170	25	6	8

"CG" Portion of Item No. (Coating and Substrate Code)

Grade	Uncoated	TiN	TiCN	TiAlN	Alcrona	Hardcut	R Coating	T Coating
Carbide	KL	KN	KC	KA	KK	KH	KR	KT
Cermet	SV	SN	SC	SA	SK	SH	SR	ST

"L" Portion of Item No. (Lead-in Recommendation)

ISO Material	E	M
P	●	
S	●	⦿
M	●	
H	⦿	●
K	⦿	●
N	●	⦿

● Best ⦿ Better ○ Good

Ordering Example:
The customer needs the following:

- Metric shank
- Carbide
- TiN coating
- F lead-in
- 30.60 mm diameter
- Through hole

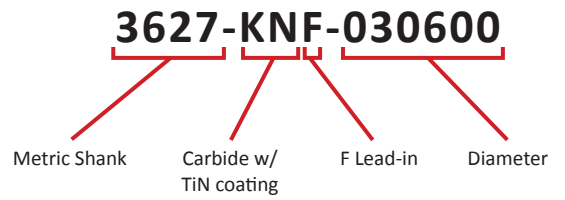
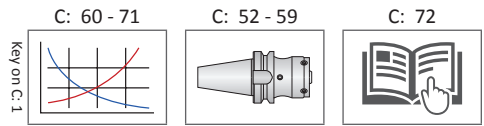

Monobloc Reamers

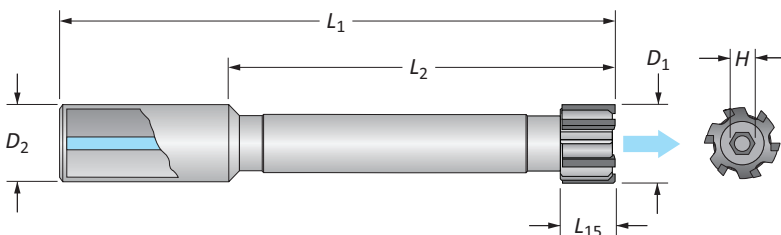

2431 Series | Long Length | Diameter Range: 0.2283" - 1.2638" (5.80 mm - 32.10 mm)

Series	2431
Flute	Straight
Type	Blind Holes
Coolant	Central



Inch Shank Part No. 92431-CGL-D ₁					Metric Shank Part No. 2431-CGL-D ₁					No. of Teeth	H (mm)
D ₁ Range	L ₁₅	L ₂	L ₁	D ₂	D ₁ Range	L ₁₅	L ₂	L ₁	D ₂		
0.2283 - 0.2598	0.315	3.346	4.843	0.500	5.80 - 6.60	8	85	123	12	4	1.5
0.2599 - 0.2992	0.315	3.346	4.843	0.500	6.61 - 7.60	8	85	123	12	4	2
0.2993 - 0.3386	0.394	3.346	4.843	0.500	7.61 - 8.60	10	85	123	12	4	2.5
0.3387 - 0.3780	0.394	3.346	4.843	0.500	8.61 - 9.60	10	85	123	12	4	2.5
0.3781 - 0.4173	0.394	4.528	6.299	0.500	9.61 - 10.60	10	115	160	12	6	3
0.4174 - 0.4567	0.394	4.528	6.299	0.500	10.61 - 11.60	10	115	160	12	6	3
0.4568 - 0.4961	0.394	4.528	6.299	0.500	11.61 - 12.60	10	115	160	12	6	3
0.4962 - 0.5354	0.394	4.528	6.299	0.500	12.61 - 13.60	10	115	160	12	6	4
0.5355 - 0.5748	0.394	4.528	6.299	0.500	13.61 - 14.60	10	115	160	12	6	4
0.5749 - 0.6142	0.394	4.528	6.299	0.500	14.61 - 15.60	10	115	160	12	6	4
0.6143 - 0.6535	0.394	5.118	7.087	0.625	15.61 - 16.60	10	130	180	16	6	4
0.6536 - 0.6929	0.394	5.118	7.087	0.625	16.61 - 17.60	10	130	180	16	6	5
0.6930 - 0.7323	0.472	5.118	7.087	0.625	17.61 - 18.60	12	130	180	16	6	5
0.7324 - 0.7520	0.472	5.512	7.874	0.750	18.61 - 19.10	12	140	200	20	6	5
0.7521 - 0.7913	0.472	5.512	7.874	0.750	19.11 - 20.10	12	140	200	20	6	5
0.7914 - 0.8307	0.472	5.512	7.874	0.750	20.11 - 21.10	12	140	200	20	6	5
0.8308 - 0.8701	0.472	5.512	7.874	0.750	21.11 - 22.10	12	140	200	20	6	6
0.8702 - 0.9094	0.472	5.512	7.874	0.750	22.11 - 23.10	12	140	200	20	6	6
0.9095 - 0.9488	0.472	5.512	7.874	0.750	23.11 - 24.10	12	140	200	20	6	6
0.9489 - 0.9882	0.472	5.512	7.874	0.750	24.11 - 25.10	12	140	200	20	6	6
0.9883 - 1.0276	0.472	5.906	8.268	1.000	25.11 - 26.10	16	150	210	25	6	6
1.0277 - 1.0669	0.551	5.906	8.268	1.000	26.11 - 27.10	16	150	210	25	6	6
1.0670 - 1.1063	0.551	5.906	8.268	1.000	27.11 - 28.10	16	150	210	25	6	8
1.1064 - 1.1457	0.551	5.906	8.268	1.000	28.11 - 29.10	16	150	210	25	6	8
1.1458 - 1.1850	0.551	5.906	8.268	1.000	29.11 - 30.10	16	150	210	25	6	8
1.1851 - 1.2244	0.551	5.906	8.268	1.000	30.11 - 31.10	16	150	210	25	6	8
1.2245 - 1.2638	0.551	5.906	8.268	1.000	31.11 - 32.10	16	150	210	25	6	8

"CG" Portion of Item No. (Coating and Substrate Code)

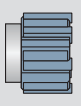
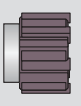
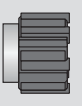
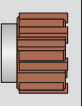
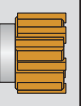
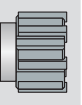
								
Grade	Uncoated	TiN	TiCN	TiAlN	Alcrona	Hardcut	R Coating	T Coating
Carbide	KL	KN	KC	KA	KK	KH	KR	KT
Cermet	SV	SN	SC	SA	SK	SH	SR	ST

"L" Portion of Item No. (Lead-in Recommendation)

ISO Material	T	F	N	G	L	A	V	K
P			●	●		○	○	○
S	●			○				
M			○	●				○
H			○	●				
K				○			●	○
N				●			○	

● Best ○ Better ○ Good

Ordering Example:

The customer needs the following:

- Metric shank
- Carbide
- TiN coating
- F lead-in
- 30.60 mm diameter
- Blind hole

2431-KNF-030600

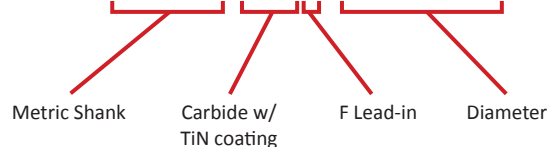

Key on C-1

C: 60 - 71

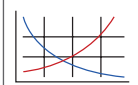

C: 52 - 59

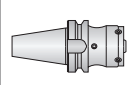

C: 72



Monobloc Reamers

3610 Series | Long Length | Diameter Range: 0.2283" - 1.2638" (5.80 mm - 32.10 mm)

Series	3610
Flute	Straight
Type	Through Holes
Coolant	Radial

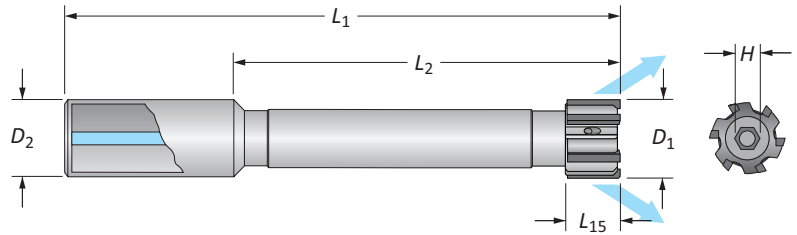

Inch Shank Part No. 93610-CGL-D ₁					Metric Shank Part No. 3610-CGL-D ₁					No. of Teeth	H (mm)
D ₁ Range	L ₁₅	L ₂	L ₁	D ₂	D ₁ Range	L ₁₅	L ₂	L ₁	D ₂		
0.2283 - 0.2598	0.315	3.346	4.843	0.500	5.80 - 6.60	8	85	123	12	4	1.5
0.2599 - 0.2992	0.315	3.346	4.843	0.500	6.61 - 7.60	8	85	123	12	4	2
0.2993 - 0.3386	0.394	3.346	4.843	0.500	7.61 - 8.60	10	85	123	12	4	2.5
0.3387 - 0.3780	0.394	3.346	4.843	0.500	8.61 - 9.60	10	85	123	12	4	2.5
0.3781 - 0.4173	0.394	4.528	6.299	0.500	9.61 - 10.60	10	115	160	12	6	3
0.4174 - 0.4567	0.394	4.528	6.299	0.500	10.61 - 11.60	10	115	160	12	6	3
0.4568 - 0.4961	0.394	4.528	6.299	0.500	11.61 - 12.60	10	115	160	12	6	3
0.4962 - 0.5354	0.394	4.528	6.299	0.500	12.61 - 13.60	10	115	160	12	6	4
0.5355 - 0.5748	0.394	4.528	6.299	0.500	13.61 - 14.60	10	115	160	12	6	4
0.5749 - 0.6142	0.394	4.528	6.299	0.500	14.61 - 15.60	10	115	160	12	6	4
0.6143 - 0.6535	0.394	5.118	7.087	0.625	15.61 - 16.60	10	130	180	16	6	4
0.6536 - 0.6929	0.394	5.118	7.087	0.625	16.61 - 17.60	10	130	180	16	6	5
0.6930 - 0.7323	0.472	5.118	7.087	0.625	17.61 - 18.60	12	130	180	16	6	5
0.7324 - 0.7520	0.472	5.512	7.874	0.750	18.61 - 19.10	12	140	200	20	6	5
0.7521 - 0.7913	0.472	5.512	7.874	0.750	19.11 - 20.10	12	140	200	20	6	5
0.7914 - 0.8307	0.472	5.512	7.874	0.750	20.11 - 21.10	12	140	200	20	6	5
0.8308 - 0.8701	0.472	5.512	7.874	0.750	21.11 - 22.10	12	140	200	20	6	6
0.8702 - 0.9094	0.472	5.512	7.874	0.750	22.11 - 23.10	12	140	200	20	6	6
0.9095 - 0.9488	0.472	5.512	7.874	0.750	23.11 - 24.10	12	140	200	20	6	6
0.9489 - 0.9882	0.472	5.512	7.874	0.750	24.11 - 25.10	12	140	200	20	6	6
0.9883 - 1.0276	0.472	5.906	8.268	1.000	25.11 - 26.10	16	150	210	25	6	6
1.0277 - 1.0669	0.551	5.906	8.268	1.000	26.11 - 27.10	16	150	210	25	6	6
1.0670 - 1.1063	0.551	5.906	8.268	1.000	27.11 - 28.10	16	150	210	25	6	8
1.1064 - 1.1457	0.551	5.906	8.268	1.000	28.11 - 29.10	16	150	210	25	6	8
1.1458 - 1.1850	0.551	5.906	8.268	1.000	29.11 - 30.10	16	150	210	25	6	8
1.1851 - 1.2244	0.551	5.906	8.268	1.000	30.11 - 31.10	16	150	210	25	6	8
1.2245 - 1.2638	0.551	5.906	8.268	1.000	31.11 - 32.10	16	150	210	25	6	8

"CG" Portion of Item No. (Coating and Substrate Code)

Grade	Uncoated	TiN	TiCN	TiAlN	Alcrona	Hardcut	R Coating	T Coating
Carbide	KL	KN	KC	KA	KK	KH	KR	KT
Cermet	SV	SN	SC	SA	SK	SH	SR	ST

"L" Portion of Item No. (Lead-in Recommendation)

ISO Material	T	F	N	G	L	A	V	K
P			●	●		○	○	○
S	●			○				
M			○	●				○
H			○	●				
K				○			●	○
N				●			○	

● Best ○ Better ○ Good

Ordering Example:

The customer needs the following:

- Metric shank
- Carbide
- TiN coating
- F lead-in
- 30.60 mm diameter
- Through hole

3610-KNF-030600

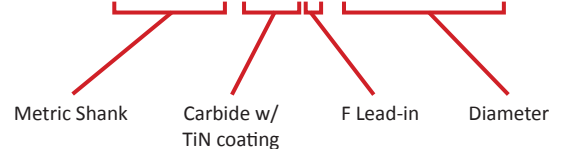

Key on C.1

C: 60 - 71

C: 52 - 59

C: 72

Monobloc Reamers

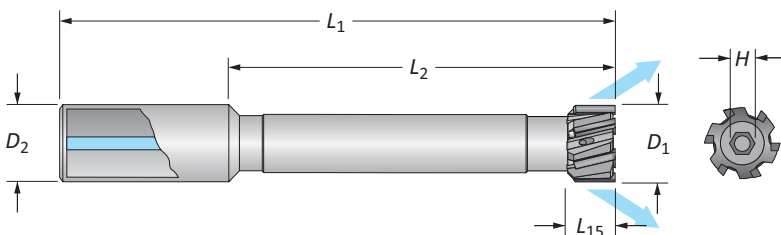

3617 Series | Long Length | Diameter Range: 0.2283" - 1.2638" (5.80 mm - 32.10 mm)

Series	3617
Flute	Helical
Type	Through Holes
Coolant	Radial

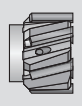

Inch Shank Part No. 93617-CGL-D ₁					Metric Shank Part No. 3617-CGL-D ₁					No. of Teeth	H (mm)
D ₁ Range	L ₁₅	L ₂	L ₁	D ₂	D ₁ Range	L ₁₅	L ₂	L ₁	D ₂		
0.2283 - 0.2598	0.315	3.346	4.843	0.500	5.80 - 6.60	8	85	123	12	4	1.5
0.2599 - 0.2992	0.315	3.346	4.843	0.500	6.61 - 7.60	8	85	123	12	4	2
0.2993 - 0.3386	0.394	3.346	4.843	0.500	7.61 - 8.60	10	85	123	12	4	2.5
0.3387 - 0.3780	0.394	3.346	4.843	0.500	8.61 - 9.60	10	85	123	12	4	2.5
0.3781 - 0.4173	0.394	4.528	6.299	0.500	9.61 - 10.60	10	115	160	12	6	3
0.4174 - 0.4567	0.394	4.528	6.299	0.500	10.61 - 11.60	10	115	160	12	6	3
0.4568 - 0.4961	0.394	4.528	6.299	0.500	11.61 - 12.60	10	115	160	12	6	3
0.4962 - 0.5354	0.394	4.528	6.299	0.500	12.61 - 13.60	10	115	160	12	6	4
0.5355 - 0.5748	0.394	4.528	6.299	0.500	13.61 - 14.60	10	115	160	12	6	4
0.5749 - 0.6142	0.394	4.528	6.299	0.500	14.61 - 15.60	10	115	160	12	6	4
0.6143 - 0.6535	0.394	5.118	7.087	0.625	15.61 - 16.60	10	130	180	16	6	4
0.6536 - 0.6929	0.394	5.118	7.087	0.625	16.61 - 17.60	10	130	180	16	6	5
0.6930 - 0.7323	0.472	5.118	7.087	0.625	17.61 - 18.60	12	130	180	16	6	5
0.7324 - 0.7520	0.472	5.512	7.874	0.750	18.61 - 19.10	12	140	200	20	6	5
0.7521 - 0.7913	0.472	5.512	7.874	0.750	19.11 - 20.10	12	140	200	20	6	5
0.7914 - 0.8307	0.472	5.512	7.874	0.750	20.11 - 21.10	12	140	200	20	6	5
0.8308 - 0.8701	0.472	5.512	7.874	0.750	21.11 - 22.10	12	140	200	20	6	6
0.8702 - 0.9094	0.472	5.512	7.874	0.750	22.11 - 23.10	12	140	200	20	6	6
0.9095 - 0.9488	0.472	5.512	7.874	0.750	23.11 - 24.10	12	140	200	20	6	6
0.9489 - 0.9882	0.472	5.512	7.874	0.750	24.11 - 25.10	12	140	200	20	6	6
0.9883 - 1.0276	0.472	5.906	8.268	1.000	25.11 - 26.10	16	150	210	25	6	6
1.0277 - 1.0669	0.551	5.906	8.268	1.000	26.11 - 27.10	16	150	210	25	6	6
1.0670 - 1.1063	0.551	5.906	8.268	1.000	27.11 - 28.10	16	150	210	25	6	8
1.1064 - 1.1457	0.551	5.906	8.268	1.000	28.11 - 29.10	16	150	210	25	6	8
1.1458 - 1.1850	0.551	5.906	8.268	1.000	29.11 - 30.10	16	150	210	25	6	8
1.1851 - 1.2244	0.551	5.906	8.268	1.000	30.11 - 31.10	16	150	210	25	6	8
1.2245 - 1.2638	0.551	5.906	8.268	1.000	31.11 - 32.10	16	150	210	25	6	8

"CG" Portion of Item No. (Coating and Substrate Code)

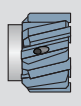
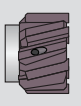
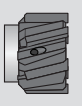
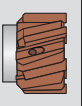
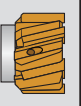
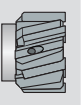
								
Grade	Uncoated	TiN	TiCN	TiAlN	Alcrona	Hardcut	R Coating	T Coating
Carbide	KL	KN	KC	KA	KK	KH	KR	KT
Cermet	SV	SN	SC	SA	SK	SH	SR	ST

"L" Portion of Item No. (Lead-in Recommendation)

ISO Material	E	M
P	●	
S	●	○
M	●	
H	○	●
K	○	●
N	●	○

● Best ○ Better ○ Good

Ordering Example:

The customer needs the following:

- Metric shank
- Carbide
- TiN coating
- F lead-in
- 30.60 mm diameter
- Through hole

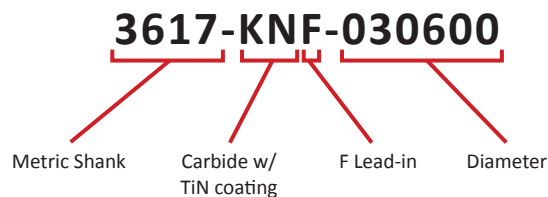
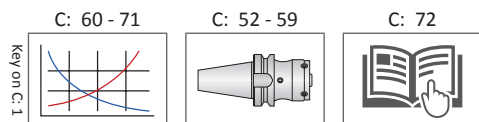

Cutting Ring Style Reamers

Product Overview

Cutting Ring Reamer Features

- Diameter range: 0.6929" - 7.8972" (17.60 mm - 200.59 mm)
- Available with straight or left-hand helical flutes
- Expandable up to 4% of nominal diameter
- Mandrels are available for both through holes or blind holes
- Work day lead time 20 - 25 days
- Available for recondition

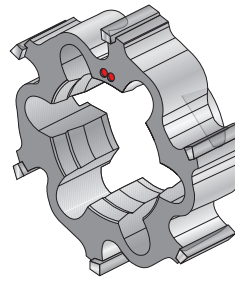

Straight Flute

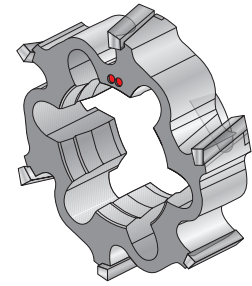

Left-Hand Helical Flute



Uncoated

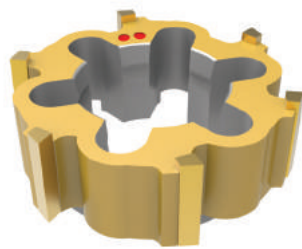

TiN Coated



TiAlN Coated

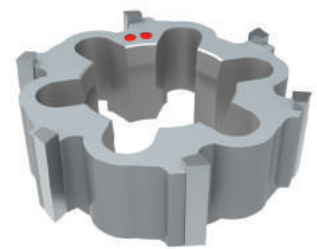

TiCN Coated



Alcrona Coated



Hardcut Coated

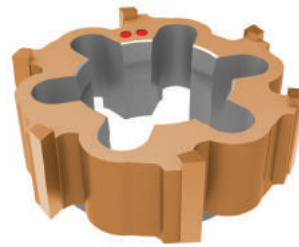

R Coated



T Coated

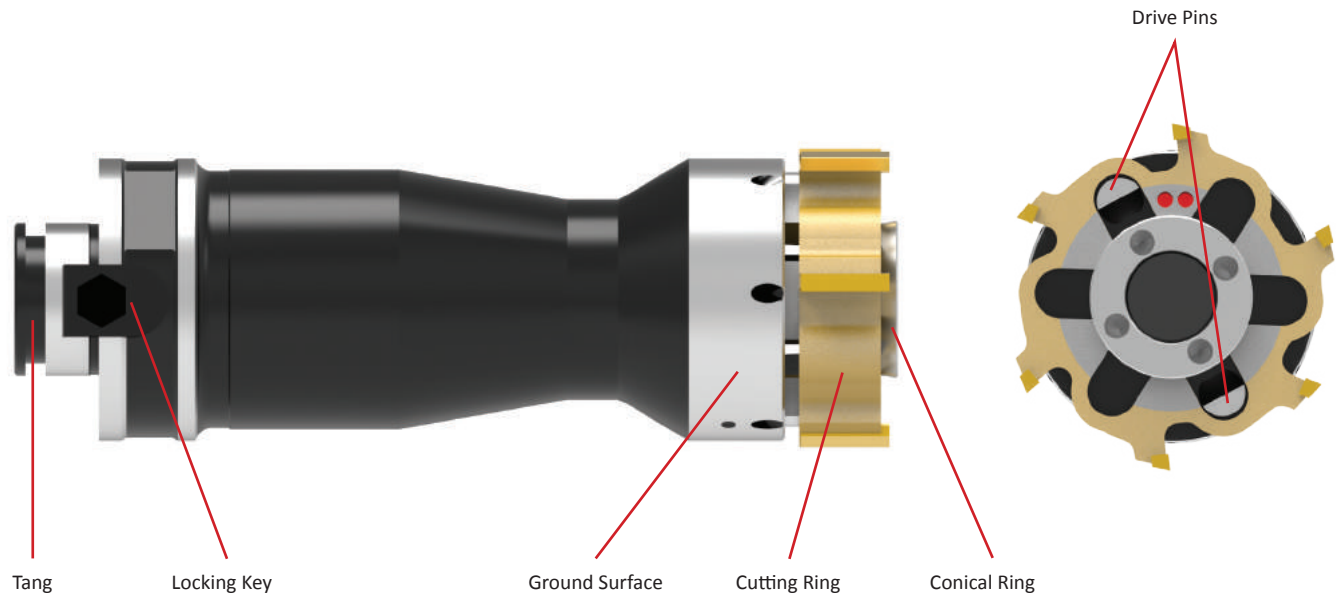

Product Nomenclature

Cutting Rings

I	2ANC-ST	F	-	019686	+	0000	-	0005
1	2	3		4		5		

NOTE: If diameter and tolerance are specified in inch units, put an "I" at the beginning of the item number

1. Diameter Unit of Measure	2. Coating and Substrate	
Blank = Metric diameter (mm) I = Imperial diameter (in)	2000-KT = Uncoated carbide	2AVC-ST = Uncoated cermet
	2TIN-KT = TiN coated carbide	2ANC-ST = TiN coated cermet
	2TIC-KT = TiCN coated carbide	2ACC-ST = TiCN coated cermet
	2TIA-KT = TiAlN coated carbide	2AAC-ST = TiAlN coated cermet
	2TLK-KT = Alcrona coated carbide	2ALK-ST = Alcrona coated cermet
	2TLH-KT = Hardcut coated carbide	2TLH-ST = Hardcut coated cermet
	2TLR-KT = R coated carbide	2TLR-ST = R coated cermet
	2TLT-KT = T coated carbide	2TLT-ST = T coated cermet

3. Lead-in	4. Diameter	5. Tolerance
E, M = Left-hand helical flute A, F, G, L, N, T, V, K = Straight flute K = Chipbreaker geometry for straight or helical flute	XX.XXXX = Imperial (inch) XXX.XXX = Metric (mm)	4 decimal places = inch tolerance 3 decimal places = mm tolerance *The total tolerance capable is 0.0002" (0.005 mm)

Reference Key

Symbol	Attribute
D_1	Reamer diameter
D_2	Shank diameter
D_3	Maximum conical ring diameter
L_1	Overall length
L_2	Length of cut
L_5	Maximum overhang
L_7	Shank length
L_{15}	Flute length

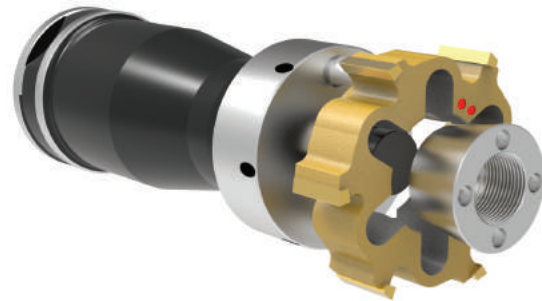
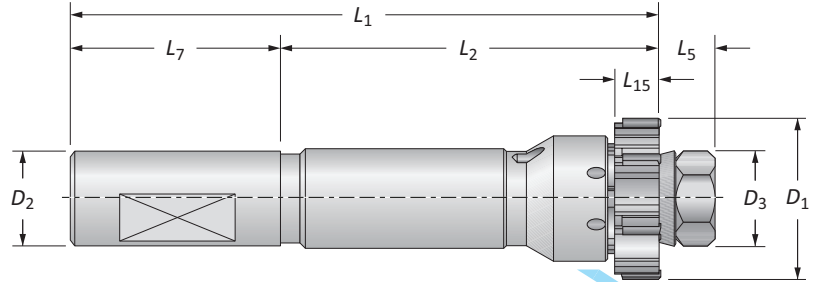

Building Your Complete Tool

You will need both pieces to complete your ring style reamer assembly. There is a guide on the page where the rings are located. You must follow the guide to build the item number for the reamer ring that you need.

However, the complete mandrel item numbers are listed on their respective pages. You do not need to build the mandrel numbers.



1

Select Your Ring

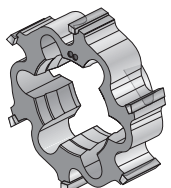



2

Select Your Mandrel



Cutting Rings

Imperial (inch) | Diameter Range: 0.6929" - 7.8976"

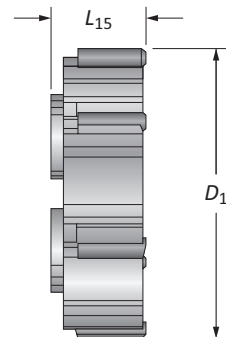
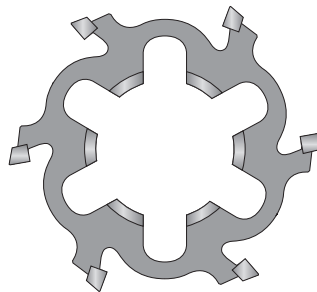
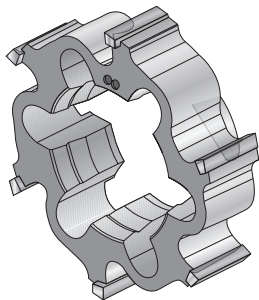

D_1 Range	L_{15}		Number of Teeth
	Imperial (inch)	Straight Flute	
0.6929 - 0.8503	0.433	–	6
0.8504 - 1.0078	0.472	–	6
1.0079 - 1.2834	0.551	–	6
1.2835 - 1.7952	0.630	0.630	6
1.7953 - 3.1338	0.728	0.728	6
3.1339 - 3.9605	0.728	0.728	8
3.9606 - 4.3542	0.728	0.728	10
4.3543 - 7.8976	0.728	0.728	12

I 2ANC-STF-019686+0002-0002

Imperial Item

Cermet w/
TiN Coating

F Lead-in

Diameter (1.9686") (D_1)Tolerance (± 0.0002 "

Coating and Substrate Codes

Grade	Uncoated	TiN	TiCN	TiAlN	Alcrona	Hardcut	R Coating	T Coating
Carbide	2000-KT	2TIN-KT	2TIC-KT	2TIA-KT	2TLK-KT	2TLH-KT	2TLR-KT	2TTL-KT
Cermet	2AVC-ST	2ANC-ST	2ACC-ST	2AAC-ST	2ALK-ST	2ALH-ST	2ALR-ST	2ALT-ST

Lead-in Recommendation (Straight Flute)

ISO Material	T	F	N	G	L	A	V	K
P			●	●		○	○	○
S	●			○				
M			○	●				○
H			○	●				
K				○			●	○
N				●			○	

● Best ○ Better ○ Good

Lead-in Recommendation (Helical Flute)

ISO Material	E	M
P	●	
S	●	○
M	●	
H	○	●
K	○	●
N	●	○

● Best ○ Better ○ Good

C: 60 - 71

C: 32 - 51

C: 52 - 59

C: 72

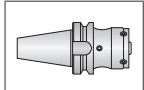
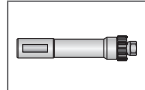
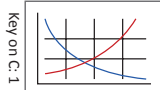

Cutting Rings

Metric (mm) | Diameter Range: 17.600 mm - 200.60 mm

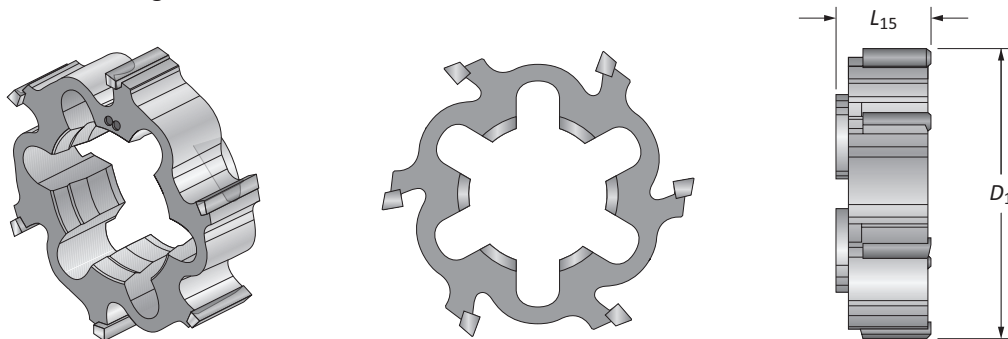

D ₁ Range Metric (mm)	L ₁₅		Number of Teeth
	Straight Flute	Helical Flute	
17.600 - 21.599	11.00	-	6
21.600 - 25.599	12.00	-	6
25.600 - 32.599	14.00	-	6
32.600 - 45.599	16.00	16.00	6
45.600 - 79.599	18.50	18.50	6
79.600 - 100.599	18.50	18.50	8
100.600 - 110.599	18.50	18.50	10
110.600 - 200.600	18.50	18.50	12

2ANC-STF-055298+003-003







Cermet w/
TiN Coating

F Lead-in

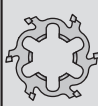
Diameter (55.298 mm) (D₁)

Tolerance (±0.003 mm)

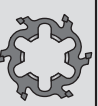
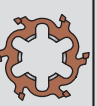
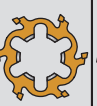
Coating and Substrate Codes

								
Grade	Uncoated	TiN	TiCN	TiAlN	Alcrona	Hardcut	R Coating	T Coating
Carbide	2000-KT	2TIN-KT	2TIC-KT	2TIA-KT	2TLK-KT	2TLH-KT	2TLR-KT	2TLT-KT
Cermet	2AVC-ST	2ANC-ST	2ACC-ST	2AAC-ST	2ALK-ST	2ALH-ST	2ALR-ST	2ALT-ST

Lead-in Recommendation (Straight Flute)

ISO Material	T	F	N	G	L	A	V	K
P			●	●		○	○	○
S	●			○				
M			○	●				○
H			○	●				
K				○			●	○
N				●			○	

● Best ○ Better ○ Good

Lead-in Recommendation (Helical Flute)

ISO Material	E	M
P	●	
S	●	○
M	●	
H	○	●
K	○	●
N	●	○

● Best ○ Better ○ Good

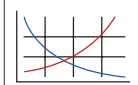
C: 60 - 71  Key on C-1

C: 32 - 51 

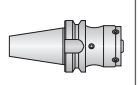
C: 52 - 59 

C: 72 

Ring Style Mandrels

4550 Series | Short Length | Diameter Range: 0.6929" - 3.9602" (17.60 mm - 100.59 mm)

Series	4550
Shank Type	Cylindrical
Application	Through Holes
Coolant	Radial

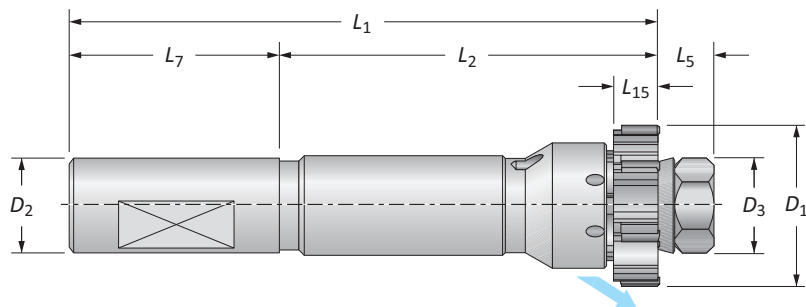

	Mandrel						Shank		Teeth	Part No. (Complete Mandrel*)	
	D ₁ Range	D ₃	L ₅	L ₁₅	L ₂	L ₁	L ₇	D ₂		With Flat	Without Flat
i	0.6929 - 0.8503	0.472	0.433	0.433	3.189	5.591	1.969	0.750	6	94550-MC-010	94550A-MC-010
	0.8504 - 1.0078	0.472	0.433	0.472	3.189	5.591	1.969	0.750	6	94550-MC-020	94550A-MC-020
	1.0079 - 1.2834	0.614	0.433	0.551	4.016	6.417	1.969	0.750	6	94550-MC-030	94550A-MC-030
	1.2835 - 1.5983	0.866	0.551	0.630	4.016	6.772	2.205	1.000	6	94550-MC-040	94550A-MC-040
	1.5984 - 1.7952	1.000	0.591	0.630	4.016	6.811	2.205	1.000	6	94550-MC-050	94550A-MC-050
	1.7953 - 1.9527	1.181	0.807	0.728	4.134	7.303	2.362	1.250	6	94550-MC-060	94550A-MC-060
	1.9528 - 2.3857	1.181	0.807	0.728	4.134	7.303	2.362	1.250	6	94550-MC-070	94550A-MC-070
	2.3858 - 2.7794	1.575	0.965	0.728	4.134	7.461	2.362	1.250	6	94550-MC-080	94550A-MC-080
	2.7795 - 3.1338	1.575	0.965	0.728	4.134	7.461	2.362	1.250	6	94550-MC-090	94550A-MC-090
	3.1339 - 3.5668	2.205	1.122	0.728	4.134	8.012	2.756	1.500	8	94550-MC-100	94550A-MC-100
3.5669 - 3.9602	2.205	1.122	0.728	4.134	8.012	2.756	1.500	8	94550-MC-110	94550A-MC-110	
m	17.60 - 21.59	12	11	11	81	142	50	20	6	4550-MC-010	4550A-MC-010
	21.60 - 25.59	12	11	12	81	142	50	20	6	4550-MC-020	4550A-MC-020
	25.60 - 32.59	15.6	11	14	102	163	50	20	6	4550-MC-030	4550A-MC-030
	32.60 - 40.59	22	14	16	102	172	56	25	6	4550-MC-040	4550A-MC-040
	40.60 - 45.59	25.4	15	16	102	173	56	25	6	4550-MC-050	4550A-MC-050
	45.60 - 49.59	30	20.5	18.5	105	185.5	60	32	6	4550-MC-060	4550A-MC-060
	49.60 - 60.59	30	20.5	18.5	105	185.5	60	32	6	4550-MC-070	4550A-MC-070
	60.60 - 70.59	40	24.5	18.5	105	189.5	60	32	6	4550-MC-080	4550A-MC-080
	70.60 - 79.59	40	24.5	18.5	105	189.5	60	32	6	4550-MC-090	4550A-MC-090
	79.60 - 90.59	56	28.5	18.5	105	203.5	70	40	8	4550-MC-100	4550A-MC-100
90.60 - 100.59	56	28.5	18.5	105	203.5	70	40	8	4550-MC-110	4550A-MC-110	

*Complete mandrel does not include cutting ring.

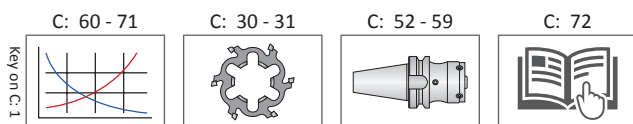
 i = Imperial (in)
 m = Metric (mm)

Ring Style Mandrels

4550 Series | Short Length | Spare Parts

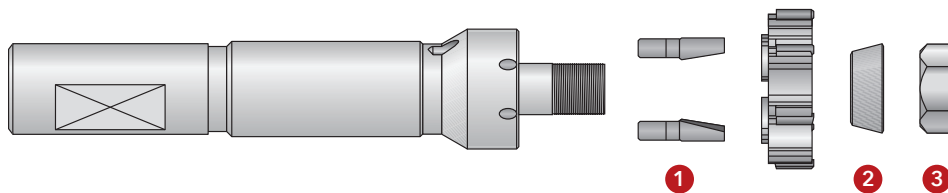

	Part No. (Complete Mandrel*)		Spare Parts				
	With Flat	Without Flat	1		2	3	
			Drive Pins	Number of Drive Pins	Conical Ring	Nut	Wrench Size (mm)
i	94550-MC-010	94550A-MC-010	2000-CO-010	3	2010-AC-010	2000-DA-010	10
	94550-MC-020	94550A-MC-020	2000-CO-020	3	2010-AC-010	2000-DA-010	10
	94550-MC-030	94550A-MC-030	2000-CO-030	3	2010-AC-020	2000-DA-020	13
	94550-MC-040	94550A-MC-040	2000-CO-040	2	2010-AC-030	2000-DA-060	19
	94550-MC-050	94550A-MC-050	2000-CO-060	2	2010-AC-040	2000-DA-090	22
	94550-MC-060	94550A-MC-060	2000-CO-060	2	2010-AC-050	2000-GH-880	30 ♦
	94550-MC-070	94550A-MC-070	2000-CO-070	2	2010-AC-050	2000-GH-880	30 ♦
	94550-MC-080	94550A-MC-080	2000-CO-080	2	2010-AC-060	2000-GH-900	40 ♦
	94550-MC-090	94550A-MC-090	2000-CO-090	2	2010-AC-060	2000-GH-900	40 ♦
	94550-MC-100	94550A-MC-100	2000-CO-090	2	2010-AC-070	2000-GH-920	56 ♦
	94550-MC-110	94550A-MC-110	2000-CO-090	2	2010-AC-070	2000-GH-920	56 ♦
ii	4550-MC-010	4550A-MC-010	2000-CO-010	3	2010-AC-010	2000-DA-010	10
	4550-MC-020	4550A-MC-020	2000-CO-020	3	2010-AC-010	2000-DA-010	10
	4550-MC-030	4550A-MC-030	2000-CO-030	3	2010-AC-020	2000-DA-020	13
	4550-MC-040	4550A-MC-040	2000-CO-040	2	2010-AC-030	2000-DA-060	19
	4550-MC-050	4550A-MC-050	2000-CO-060	2	2010-AC-040	2000-DA-090	22
	4550-MC-060	4550A-MC-060	2000-CO-060	2	2010-AC-050	2000-GH-880	30 ♦
	4550-MC-070	4550A-MC-070	2000-CO-070	2	2010-AC-050	2000-GH-880	30 ♦
	4550-MC-080	4550A-MC-080	2000-CO-080	2	2010-AC-060	2000-GH-900	40 ♦
	4550-MC-090	4550A-MC-090	2000-CO-090	2	2010-AC-060	2000-GH-900	40 ♦
	4550-MC-100	4550A-MC-100	2000-CO-090	2	2010-AC-070	2000-GH-920	56 ♦
	4550-MC-110	4550A-MC-110	2000-CO-090	2	2010-AC-070	2000-GH-920	56 ♦

*Complete mandrel does not include cutting ring.

♦ Spanner wrench

Key on C: 1

C: 60 - 71

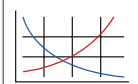

C: 30 - 31



C: 52 - 59

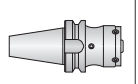

C: 72



i = Imperial (in)
ii = Metric (mm)

Ring Style Mandrels

4555 Series | Short Length | Diameter Range: 0.6929" - 3.9602" (17.60 mm - 100.59 mm)

Series	4555
Shank Type	Cylindrical
Application	Blind Holes
Coolant	Radial

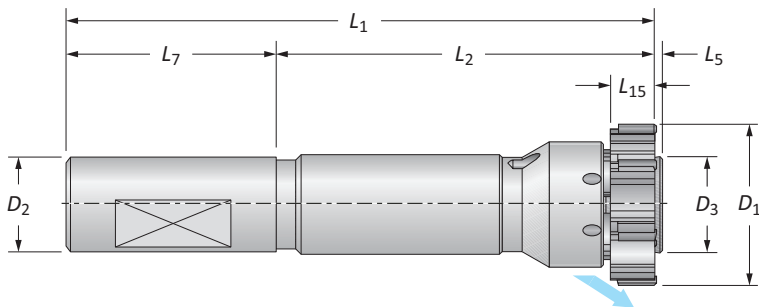

	Mandrel						Shank		Teeth	Part No. (Complete Mandrel*)	
	D ₁ Range	D ₃	L ₅	L ₁₅	L ₂	L ₁	L ₇	D ₂		With Flat	Without Flat
	0.6929 - 0.8503	0.441	0.039	0.433	3.189	5.197	1.969	0.750	6	94555-MC-010	94555A-MC-010
	0.8504 - 1.0078	0.441	0.039	0.472	3.189	5.197	1.969	0.750	6	94555-MC-020	94555A-MC-020
	1.0079 - 1.1653	0.594	0.039	0.551	4.016	6.024	1.969	0.750	6	94555-MC-030	94555A-MC-030
	1.1654 - 1.2834	0.594	0.039	0.551	4.016	6.024	1.969	0.750	6	94555-MC-035	94555A-MC-035
	1.2835 - 1.4408	0.799	0.039	0.630	4.016	6.260	2.205	1.000	6	94555-MC-040	94555A-MC-040
	1.4409 - 1.5983	0.799	0.039	0.630	4.016	6.260	2.205	1.000	6	94555-MC-045	94555A-MC-045
	1.5984 - 1.7952	0.949	0.039	0.630	4.016	6.260	2.205	1.000	6	94555-MC-050	94555A-MC-050
i	1.7953 - 1.9527	1.098	0.059	0.728	4.134	6.555	2.362	1.250	6	94555-MC-060	94555A-MC-060
	1.9528 - 2.1889	1.098	0.059	0.728	4.134	6.555	2.362	1.250	6	94555-MC-070	94555A-MC-070
	2.1890 - 2.3857	1.098	0.059	0.728	4.134	6.555	2.362	1.250	6	94555-MC-075	94555A-MC-075
	2.3858 - 2.5826	1.461	0.059	0.728	4.134	6.555	2.362	1.250	6	94555-MC-080	94555A-MC-080
	2.5827 - 2.7794	1.461	0.059	0.728	4.134	6.555	2.362	1.250	6	94555-MC-085	94555A-MC-085
	2.7795 - 3.1338	1.461	0.059	0.728	4.134	6.555	2.362	1.250	6	94555-MC-090	94555A-MC-090
	3.1339 - 3.5668	2.091	0.059	0.728	4.134	6.949	2.756	1.500	8	94555-MC-100	94555A-MC-100
	3.5669 - 3.9602	2.091	0.059	0.728	4.134	6.949	2.756	1.500	8	94555-MC-110	94555A-MC-110
	17.60 - 21.59	11.2	1	11	81	132	50	20	6	4555-MC-010	4555A-MC-010
	21.60 - 25.59	11.2	1	12	81	132	50	20	6	4555-MC-020	4555A-MC-020
	25.60 - 29.59	15.1	1	14	102	153	50	20	6	4555-MC-030	4555A-MC-030
	29.60 - 32.59	15.1	1	14	102	153	50	20	6	4555-MC-035	4555A-MC-035
	32.60 - 36.59	20.3	1	16	102	159	56	25	6	4555-MC-040	4555A-MC-040
	36.60 - 40.59	20.3	1	16	102	159	56	25	6	4555-MC-045	4555A-MC-045
m	40.60 - 45.59	24.1	1	16	102	159	56	25	6	4555-MC-050	4555A-MC-050
	45.60 - 49.59	27.9	1.5	18.5	105	166.5	60	32	6	4555-MC-060	4555A-MC-060
	49.60 - 55.59	27.9	1.5	18.5	105	166.5	60	32	6	4555-MC-070	4555A-MC-070
	55.60 - 60.59	27.9	1.5	18.5	105	166.5	60	32	6	4555-MC-075	4555A-MC-075
	60.60 - 65.59	37.1	1.5	18.5	105	166.5	60	32	6	4555-MC-080	4555A-MC-080
	65.60 - 70.59	37.1	1.5	18.5	105	166.5	60	32	6	4555-MC-085	4555A-MC-085
	70.60 - 79.59	37.1	1.5	18.5	105	166.5	60	32	6	4555-MC-090	4555A-MC-090
	79.60 - 90.59	53.1	1.5	18.5	105	176.5	70	40	8	4555-MC-100	4555A-MC-100
	90.60 - 100.59	53.1	1.5	18.5	105	176.5	70	40	8	4555-MC-110	4555A-MC-110

*Complete mandrel does not include cutting ring.

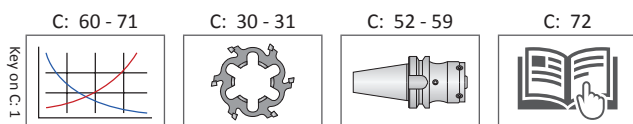

i = Imperial (in)
m = Metric (mm)

Ring Style Mandrels

4555 Series | Short Length | Spare Parts

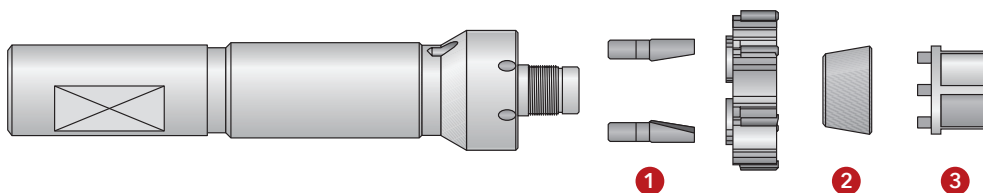

Part No. (Complete Mandrel*)		Spare Parts							Wrench Size (mm)
With Flat	Without Flat	1 Drive Pins	Number of Drive Pins	2 Conical Ring	Conical Ring (2nd Expansion)	Conical Ring (3rd Expansion)	3 Adjusting Key		
94555-MC-010	94555A-MC-010	2000-CO-010	3	4001-AC-115	4001-AC-215	-	4001-CH-015	10	
94555-MC-020	94555A-MC-020	2000-CO-020	3	4001-AC-115	4001-AC-215	-	4001-CH-015	10	
94555-MC-030	94555A-MC-030	2000-CO-030	3	4001-AC-125	4001-AC-225	4001-AC-325	4001-CH-025	13	
94555-MC-035	94555A-MC-035	2000-CO-040	2	4001-AC-125	4001-AC-225	4001-AC-325	4001-CH-025	13	
94555-MC-040	94555A-MC-040	2000-CO-040	2	4001-AC-135	4001-AC-235	4001-AC-335	4001-CH-035	18	
94555-MC-045	94555A-MC-045	2000-CO-050	2	4001-AC-135	4001-AC-235	4001-AC-335	4001-CH-035	18	
94555-MC-050	94555A-MC-050	2000-CO-060	2	4001-AC-145	4001-AC-245	4001-AC-345	4001-CH-045	22	
94555-MC-060	94555A-MC-060	2000-CO-060	2	4001-AC-155	4001-AC-255	4001-AC-355	4001-CH-055	26	
94555-MC-070	94555A-MC-070	2000-CO-070	2	4001-AC-155	4001-AC-255	4001-AC-355	4001-CH-055	26	
94555-MC-075	94555A-MC-075	2000-CO-080	2	4001-AC-155	4001-AC-255	4001-AC-355	4001-CH-055	26	
94555-MC-080	94555A-MC-080	2000-CO-080	2	4001-AC-165	4001-AC-265	4001-AC-365	4001-CH-065	34	
94555-MC-085	94555A-MC-085	2000-CO-090	2	4001-AC-165	4001-AC-265	4001-AC-365	4001-CH-065	34	
94555-MC-090	94555A-MC-090	2000-CO-090	2	4001-AC-165	4001-AC-265	4001-AC-365	4001-CH-065	34	
94555-MC-100	94555A-MC-100	2000-CO-090	2	4001-AC-185	4001-AC-285	4001-AC-385	4001-CH-085	46	
94555-MC-110	94555A-MC-110	2000-CO-090	2	4001-AC-185	4001-AC-285	4001-AC-385	4001-CH-085	46	
4555-MC-010	4555A-MC-010	2000-CO-010	3	4001-AC-115	4001-AC-215	-	4001-CH-015	10	
4555-MC-020	4555A-MC-020	2000-CO-020	3	4001-AC-115	4001-AC-215	-	4001-CH-015	10	
4555-MC-030	4555A-MC-030	2000-CO-030	3	4001-AC-125	4001-AC-225	4001-AC-325	4001-CH-025	13	
4555-MC-035	4555A-MC-035	2000-CO-040	2	4001-AC-125	4001-AC-225	4001-AC-325	4001-CH-025	13	
4555-MC-040	4555A-MC-040	2000-CO-040	2	4001-AC-135	4001-AC-235	4001-AC-335	4001-CH-035	18	
4555-MC-045	4555A-MC-045	2000-CO-050	2	4001-AC-135	4001-AC-235	4001-AC-335	4001-CH-035	18	
4555-MC-050	4555A-MC-050	2000-CO-060	2	4001-AC-145	4001-AC-245	4001-AC-345	4001-CH-045	22	
4555-MC-060	4555A-MC-060	2000-CO-060	2	4001-AC-155	4001-AC-255	4001-AC-355	4001-CH-055	26	
4555-MC-070	4555A-MC-070	2000-CO-070	2	4001-AC-155	4001-AC-255	4001-AC-355	4001-CH-055	26	
4555-MC-075	4555A-MC-075	2000-CO-080	2	4001-AC-155	4001-AC-255	4001-AC-355	4001-CH-055	26	
4555-MC-080	4555A-MC-080	2000-CO-080	2	4001-AC-165	4001-AC-265	4001-AC-365	4001-CH-065	34	
4555-MC-085	4555A-MC-085	2000-CO-090	2	4001-AC-165	4001-AC-265	4001-AC-365	4001-CH-065	34	
4555-MC-090	4555A-MC-090	2000-CO-090	2	4001-AC-165	4001-AC-265	4001-AC-365	4001-CH-065	34	
4555-MC-100	4555A-MC-100	2000-CO-090	2	4001-AC-185	4001-AC-285	4001-AC-385	4001-CH-085	46	
4555-MC-110	4555A-MC-110	2000-CO-090	2	4001-AC-185	4001-AC-285	4001-AC-385	4001-CH-085	46	

*Complete mandrel does not include cutting ring.

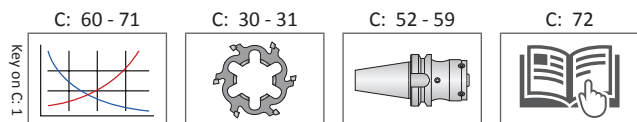

ⓘ = Imperial (in)
Ⓜ = Metric (mm)

Ring Style Mandrels

4500 Series | Long Length | Diameter Range: 0.6929" - 3.9602" (17.60 mm - 100.59 mm)

Series	4500
Shank Type	Cylindrical
Application	Through Holes
Coolant	Radial

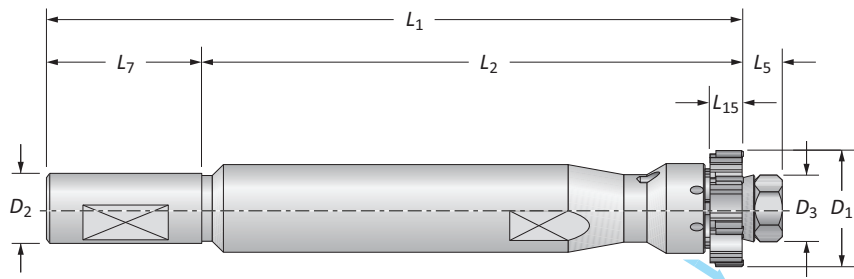

	Mandrel						Shank		Teeth	Part No. (Complete Mandrel*)	
	D ₁ Range	D ₃	L ₅	L ₁₅	L ₂	L ₁	L ₇	D ₂		With Flat	Without Flat
i	0.6929 - 0.8503	0.472	0.433	0.433	4.764	7.165	1.969	0.750	6	94500-MC-010	94500A-MC-010
	0.8504 - 1.0078	0.472	0.433	0.472	4.764	7.165	1.969	0.750	6	94500-MC-020	94500A-MC-020
	1.0079 - 1.2834	0.614	0.433	0.551	6.024	8.425	1.969	0.750	6	94500-MC-030	94500A-MC-030
	1.2835 - 1.5983	0.866	0.551	0.630	7.047	9.803	2.205	1.000	6	94500-MC-040	94500A-MC-040
	1.5984 - 1.7952	0.866	0.551	0.630	7.047	9.803	2.205	1.000	6	94500-MC-050	94500A-MC-050
	1.7953 - 1.9527	1.000	0.591	0.630	7.913	10.709	2.205	1.000	6	94500-MC-060	94500A-MC-060
	1.9528 - 2.3857	1.181	0.807	0.728	8.425	11.594	2.362	1.250	6	94500-MC-070	94500A-MC-070
	2.3858 - 2.7794	1.575	0.965	0.728	9.331	12.657	2.362	1.250	6	94500-MC-080	94500A-MC-080
	2.7795 - 3.1338	1.575	0.965	0.728	9.331	12.657	2.362	1.250	6	94500-MC-090	94500A-MC-090
	3.1339 - 3.5668	2.205	1.122	0.728	9.646	13.524	2.756	1.500	6	94500-MC-100	94500A-MC-100
3.5669 - 3.9602	2.205	1.122	0.728	9.646	13.524	2.756	1.500	8	94500-MC-110	94500A-MC-110	
m	17.60 - 21.59	12	11	11	121	182	50	20	6	4500-MC-010	4500A-MC-010
	21.60 - 25.59	12	11	12	121	182	50	20	6	4500-MC-020	4500A-MC-020
	25.60 - 32.59	15.6	11	14	153	214	50	20	6	4500-MC-030	4500A-MC-030
	32.60 - 40.59	22	14	16	179	249	56	25	6	4500-MC-040	4500A-MC-040
	40.60 - 45.59	25.4	15	16	201	272	56	25	6	4500-MC-050	4500A-MC-050
	45.60 - 49.59	30	20.5	18.5	214	294.5	60	32	6	4500-MC-060	4500A-MC-060
	49.60 - 60.59	30	20.5	18.5	214	294.5	60	32	6	4500-MC-070	4500A-MC-070
	60.60 - 70.59	40	24.5	18.5	237	321.5	60	32	6	4500-MC-080	4500A-MC-080
	70.60 - 79.59	40	24.5	18.5	237	321.5	60	32	6	4500-MC-090	4500A-MC-090
	79.60 - 90.59	56	28.5	18.5	245	343.5	70	40	6	4500-MC-100	4500A-MC-100
90.60 - 100.59	56	28.5	18.5	245	343.5	70	40	8	4500-MC-110	4500A-MC-110	

*Complete mandrel does not include cutting ring.

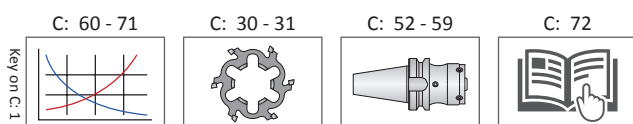
 i = Imperial (in)
 m = Metric (mm)

Ring Style Mandrels

4500 Series | Long Length | Spare Parts

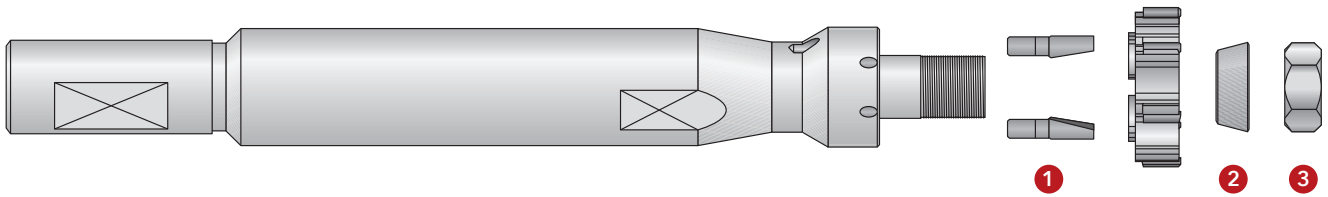

	Part No. (Complete Mandrel*)		Spare Parts				
	With Flat	Without Flat	1		2	3	
			Drive Pins	Number of Drive Pins	Conical Ring	Nut	Wrench Size (mm)
i	94500-MC-010	94500A-MC-010	2000-CO-010	3	2010-AC-010	2000-DA-010	10
	94500-MC-020	94500A-MC-020	2000-CO-020	3	2010-AC-010	2000-DA-010	10
	94500-MC-030	94500A-MC-030	2000-CO-030	3	2010-AC-020	2000-DA-020	13
	94500-MC-040	94500A-MC-040	2000-CO-040	2	2010-AC-030	2000-DA-060	19
	94500-MC-050	94500A-MC-050	2000-CO-060	2	2010-AC-040	2000-DA-090	22
	94500-MC-060	94500A-MC-060	2000-CO-060	2	2010-AC-050	2000-GH-880	30 ♦
	94500-MC-070	94500A-MC-070	2000-CO-070	2	2010-AC-050	2000-GH-880	30 ♦
	94500-MC-080	94500A-MC-080	2000-CO-080	2	2010-AC-060	2000-GH-900	40 ♦
	94500-MC-090	94500A-MC-090	2000-CO-090	2	2010-AC-060	2000-GH-900	40 ♦
	94500-MC-100	94500A-MC-100	2000-CO-090	2	2010-AC-070	2000-GH-920	56 ♦
	94500-MC-110	94500A-MC-110	2000-CO-090	2	2010-AC-070	2000-GH-920	56 ♦
ii	4500-MC-010	4500A-MC-010	2000-CO-010	3	2010-AC-010	2000-DA-010	10
	4500-MC-020	4500A-MC-020	2000-CO-020	3	2010-AC-010	2000-DA-010	10
	4500-MC-030	4500A-MC-030	2000-CO-030	3	2010-AC-020	2000-DA-020	13
	4500-MC-040	4500A-MC-040	2000-CO-040	2	2010-AC-030	2000-DA-060	19
	4500-MC-050	4500A-MC-050	2000-CO-060	2	2010-AC-040	2000-DA-090	22
	4500-MC-060	4500A-MC-060	2000-CO-060	2	2010-AC-050	2000-GH-880	30 ♦
	4500-MC-070	4500A-MC-070	2000-CO-070	2	2010-AC-050	2000-GH-880	30 ♦
	4500-MC-080	4500A-MC-080	2000-CO-080	2	2010-AC-060	2000-GH-900	40 ♦
	4500-MC-090	4500A-MC-090	2000-CO-090	2	2010-AC-060	2000-GH-900	40 ♦
	4500-MC-100	4500A-MC-100	2000-CO-090	2	2010-AC-070	2000-GH-920	56 ♦
	4500-MC-110	4500A-MC-110	2000-CO-090	2	2010-AC-070	2000-GH-920	56 ♦

*Complete mandrel does not include cutting ring.

♦ Spanner wrench

Key on C: 1

C: 60 - 71

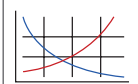

C: 30 - 31



C: 52 - 59

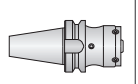

C: 72



i = Imperial (in)
ii = Metric (mm)

Ring Style Mandrels

4505 Series | Long Length | Diameter Range: 0.6929" - 3.9602" (17.60 mm - 100.59 mm)

Series	4505
Shank Type	Cylindrical
Application	Blind Holes
Coolant	Radial

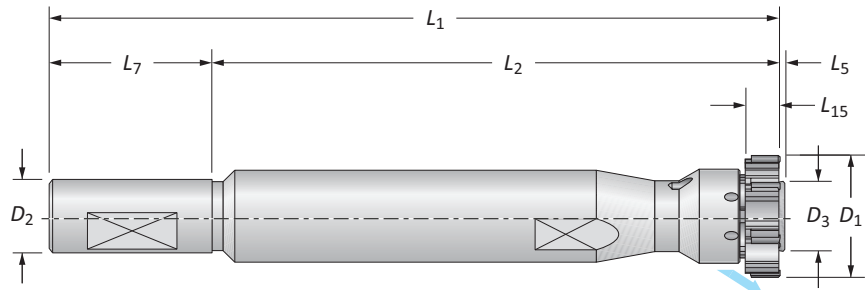

D ₁ Range	Mandrel					Shank			Teeth	Part No. (Complete Mandrel*)	
	D ₃	L ₅	L ₁₅	L ₂	L ₁	L ₇	D ₂	With Flat		Without Flat	
0.6929 - 0.8503	0.441	0.039	0.433	4.764	6.772	1.969	0.750	6	94505-MC-010	94505A-MC-010	
0.8504 - 1.0078	0.441	0.039	0.472	4.764	6.772	1.969	0.750	6	94505-MC-020	94505A-MC-020	
1.0079 - 1.1653	0.594	0.039	0.551	6.024	8.031	1.969	0.750	6	94505-MC-030	94505A-MC-030	
1.1654 - 1.2834	0.594	0.039	0.551	6.024	8.031	1.969	0.750	6	94505-MC-035	94505A-MC-035	
1.2835 - 1.4408	0.799	0.039	0.630	7.047	9.291	2.205	1.000	6	94505-MC-040	94505A-MC-040	
1.4409 - 1.5983	0.799	0.039	0.630	7.047	9.291	2.205	1.000	6	94505-MC-045	94505A-MC-045	
1.5984 - 1.7952	0.949	0.039	0.630	7.913	10.157	2.205	1.000	6	94505-MC-050	94505A-MC-050	
1.7953 - 1.9527	1.098	0.059	0.728	8.425	10.846	2.362	1.250	6	94505-MC-060	94505A-MC-060	
1.9528 - 2.1889	1.098	0.059	0.728	8.425	10.846	2.362	1.250	6	94505-MC-070	94505A-MC-070	
2.1890 - 2.3857	1.098	0.059	0.728	8.425	10.846	2.362	1.250	6	94505-MC-075	94505A-MC-075	
2.3858 - 2.5826	1.461	0.059	0.728	9.331	11.752	2.362	1.250	6	94505-MC-080	94505A-MC-080	
2.5827 - 2.7794	1.461	0.059	0.728	9.331	11.752	2.362	1.250	6	94505-MC-085	94505A-MC-085	
2.7795 - 3.1338	1.461	0.059	0.728	9.331	11.752	2.362	1.250	6	94505-MC-090	94505A-MC-090	
3.1339 - 3.5668	2.091	0.059	0.728	9.646	12.461	2.756	1.500	8	94505-MC-100	94505A-MC-100	
3.5669 - 3.9602	2.091	0.059	0.728	9.646	12.461	2.756	1.500	8	94505-MC-110	94505A-MC-110	
17.60 - 21.59	11.2	1	11	121	172	50	20	6	4505-MC-010	4505A-MC-010	
21.60 - 25.59	11.2	1	12	121	172	50	20	6	4505-MC-020	4505A-MC-020	
25.60 - 29.59	15.1	1	14	153	204	50	20	6	4505-MC-030	4505A-MC-030	
29.60 - 32.59	15.1	1	14	153	204	50	20	6	4505-MC-035	4505A-MC-035	
32.60 - 36.59	20.3	1	16	179	236	56	25	6	4505-MC-040	4505A-MC-040	
36.60 - 40.59	20.3	1	16	179	236	56	25	6	4505-MC-045	4505A-MC-045	
40.60 - 45.59	24.1	1	16	201	258	56	25	6	4505-MC-050	4505A-MC-050	
45.60 - 49.59	27.9	1.5	18.5	214	275.5	60	32	6	4505-MC-060	4505A-MC-060	
49.60 - 55.59	27.9	1.5	18.5	214	275.5	60	32	6	4505-MC-070	4505A-MC-070	
55.60 - 60.59	27.9	1.5	18.5	214	275.5	60	32	6	4505-MC-075	4505A-MC-075	
60.60 - 65.59	37.1	1.5	18.5	237	298.5	60	32	6	4505-MC-080	4505A-MC-080	
65.60 - 70.59	37.1	1.5	18.5	237	298.5	60	32	6	4505-MC-085	4505A-MC-085	
70.60 - 79.59	37.1	1.5	18.5	237	298.5	60	32	6	4505-MC-090	4505A-MC-090	
79.60 - 90.59	53.1	1.5	18.5	245	316.5	70	40	8	4505-MC-100	4505A-MC-100	
90.60 - 100.59	53.1	1.5	18.5	245	316.5	70	40	8	4505-MC-110	4505A-MC-110	

*Complete mandrel does not include cutting ring.

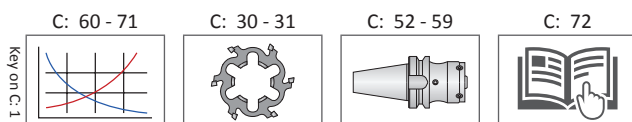

i = Imperial (in)
m = Metric (mm)

Ring Style Mandrels

4505 Series | Long Length | Spare Parts

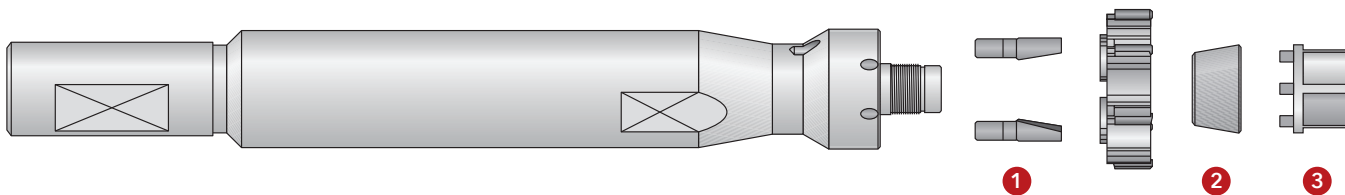

Part No. (Complete Mandrel*)		Spare Parts							Wrench Size (mm)
With Flat	Without Flat	1 Drive Pins	Number of Drive Pins	2 Conical Ring	Conical Ring (2nd Expansion)	Conical Ring (3rd Expansion)	3 Adjusting Key		
94505-MC-010	94505A-MC-010	2000-CO-010	3	4001-AC-115	4001-AC-215	-	4001-CH-015	10	
94505-MC-020	94505A-MC-020	2000-CO-020	3	4001-AC-115	4001-AC-215	-	4001-CH-015	10	
94505-MC-030	94505A-MC-030	2000-CO-030	3	4001-AC-125	4001-AC-225	4001-AC-325	4001-CH-025	13	
94505-MC-035	94505A-MC-035	2000-CO-040	2	4001-AC-125	4001-AC-225	4001-AC-325	4001-CH-025	13	
94505-MC-040	94505A-MC-040	2000-CO-040	2	4001-AC-135	4001-AC-235	4001-AC-335	4001-CH-035	18	
94505-MC-045	94505A-MC-045	2000-CO-050	2	4001-AC-135	4001-AC-235	4001-AC-335	4001-CH-035	18	
94505-MC-050	94505A-MC-050	2000-CO-060	2	4001-AC-145	4001-AC-245	4001-AC-345	4001-CH-045	22	
94505-MC-060	94505A-MC-060	2000-CO-060	2	4001-AC-155	4001-AC-255	4001-AC-355	4001-CH-055	26	
94505-MC-070	94505A-MC-070	2000-CO-070	2	4001-AC-155	4001-AC-255	4001-AC-355	4001-CH-055	26	
94505-MC-075	94505A-MC-075	2000-CO-080	2	4001-AC-155	4001-AC-255	4001-AC-355	4001-CH-055	26	
94505-MC-080	94505A-MC-080	2000-CO-080	2	4001-AC-165	4001-AC-265	4001-AC-365	4001-CH-065	34	
94505-MC-085	94505A-MC-085	2000-CO-090	2	4001-AC-165	4001-AC-265	4001-AC-365	4001-CH-065	34	
94505-MC-090	94505A-MC-090	2000-CO-090	2	4001-AC-165	4001-AC-265	4001-AC-365	4001-CH-065	34	
94505-MC-100	94505A-MC-100	2000-CO-090	2	4001-AC-185	4001-AC-285	4001-AC-385	4001-CH-085	46	
94505-MC-110	94505A-MC-110	2000-CO-090	2	4001-AC-185	4001-AC-285	4001-AC-385	4001-CH-085	46	
4505-MC-010	4505A-MC-010	2000-CO-010	3	4001-AC-115	4001-AC-215	-	4001-CH-015	10	
4505-MC-020	4505A-MC-020	2000-CO-020	3	4001-AC-115	4001-AC-215	-	4001-CH-015	10	
4505-MC-030	4505A-MC-030	2000-CO-030	3	4001-AC-125	4001-AC-225	4001-AC-325	4001-CH-025	13	
4505-MC-035	4505A-MC-035	2000-CO-040	2	4001-AC-125	4001-AC-225	4001-AC-325	4001-CH-025	13	
4505-MC-040	4505A-MC-040	2000-CO-040	2	4001-AC-135	4001-AC-235	4001-AC-335	4001-CH-035	18	
4505-MC-045	4505A-MC-045	2000-CO-050	2	4001-AC-135	4001-AC-235	4001-AC-335	4001-CH-035	18	
4505-MC-050	4505A-MC-050	2000-CO-060	2	4001-AC-145	4001-AC-245	4001-AC-345	4001-CH-045	22	
4505-MC-060	4505A-MC-060	2000-CO-060	2	4001-AC-155	4001-AC-255	4001-AC-355	4001-CH-055	26	
4505-MC-070	4505A-MC-070	2000-CO-070	2	4001-AC-155	4001-AC-255	4001-AC-355	4001-CH-055	26	
4505-MC-075	4505A-MC-075	2000-CO-080	2	4001-AC-155	4001-AC-255	4001-AC-355	4001-CH-055	26	
4505-MC-080	4505A-MC-080	2000-CO-080	2	4001-AC-165	4001-AC-265	4001-AC-365	4001-CH-065	34	
4505-MC-085	4505A-MC-085	2000-CO-090	2	4001-AC-165	4001-AC-265	4001-AC-365	4001-CH-065	34	
4505-MC-090	4505A-MC-090	2000-CO-090	2	4001-AC-165	4001-AC-265	4001-AC-365	4001-CH-065	34	
4505-MC-100	4505A-MC-100	2000-CO-090	2	4001-AC-185	4001-AC-285	4001-AC-385	4001-CH-085	46	
4505-MC-110	4505A-MC-110	2000-CO-090	2	4001-AC-185	4001-AC-285	4001-AC-385	4001-CH-085	46	

*Complete mandrel does not include cutting ring.

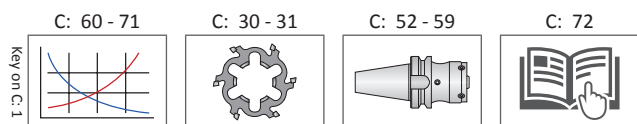

ⓘ = Imperial (in)
Ⓜ = Metric (mm)

Ring Style Mandrels

4330 Series | Short Length | Diameter Range: 0.6929" - 3.9602" (17.60 mm - 100.59 mm)

Series	4330
Shank Type	Modular
Application	Through Holes
Coolant	Radial

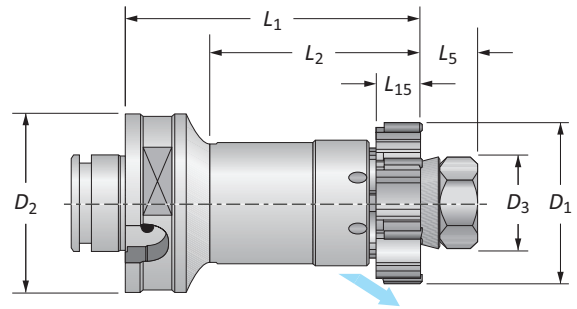

D_1 Range		Mandrel					Shank	Teeth	Part No. (Complete Mandrel*)
Imperial (inch)	Metric (mm)	D_3	L_5	L_{15}	L_2	L_1	D_2		
0.6929 - 0.8503	17.60 - 21.59	12	11	11	55	75	50	6	4330-MC-010
0.8504 - 1.0078	21.60 - 25.59	12	11	12	55	75	50	6	4330-MC-020
1.0079 - 1.2834	25.60 - 32.59	15.6	11	14	60	80	50	6	4330-MC-030
1.2835 - 1.5983	32.60 - 40.59	22	14	16	60	80	50	6	4330-MC-040
1.5984 - 1.7952	40.60 - 45.59	25.4	15	16	60	80	50	6	4330-MC-050
m 1.7953 - 1.9527	45.60 - 49.59	30	20.5	18.5	60	80	50	6	4330-MC-060
1.9528 - 2.3857	49.60 - 60.59	30	20.5	18.5	60	80	50	6	4330-MC-070
2.3858 - 2.7794	60.60 - 70.59	40	24.5	18.5	65	90	63	6	4330-MC-080
2.7795 - 3.1338	70.60 - 79.59	40	24.5	18.5	65	90	63	6	4330-MC-090
3.1339 - 3.5668	79.60 - 90.59	56	28.5	18.5	65	90	63	8	4330-MC-100
3.5669 - 3.9602	90.60 - 100.59	56	28.5	18.5	65	90	63	8	4330-MC-110

*Complete mandrel does not include cutting ring.

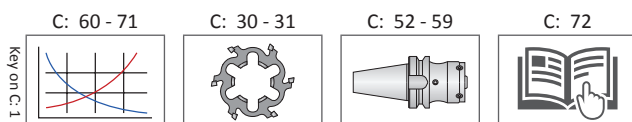

Key on C: 1

i = Imperial (in)
m = Metric (mm)

Ring Style Mandrels

4330 Series | Short Length | Spare Parts

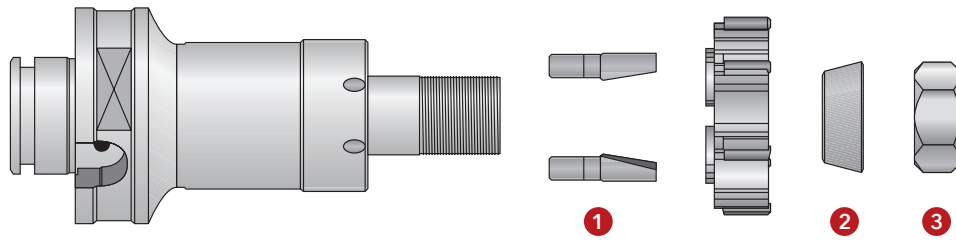

Part No. (Complete Mandrel*)	Spare Parts					Wrench Size (mm)
	1 Drive Pins	Number of Drive Pins	2 Conical Ring	3 Nut		
4330-MC-010	2000-CO-010	3	2010-AC-010	2000-DA-010	10	
4330-MC-020	2000-CO-020	3	2010-AC-010	2000-DA-010	10	
4330-MC-030	2000-CO-030	3	2010-AC-020	2000-DA-020	13	
4330-MC-040	2000-CO-040	2	2010-AC-030	2000-DA-060	19	
4330-MC-050	2000-CO-060	2	2010-AC-040	2000-DA-090	22	
4330-MC-060	2000-CO-060	2	2010-AC-050	2000-GH-880	30 ♦	
4330-MC-070	2000-CO-070	2	2010-AC-050	2000-GH-880	30 ♦	
4330-MC-080	2000-CO-080	2	2010-AC-060	2000-GH-900	40 ♦	
4330-MC-090	2000-CO-090	2	2010-AC-060	2000-GH-900	40 ♦	
4330-MC-100	2000-CO-090	2	2010-AC-070	2000-GH-920	56 ♦	
4330-MC-110	2000-CO-090	2	2010-AC-070	2000-GH-920	56 ♦	

*Complete mandrel does not include cutting ring.

♦ Spanner wrench

Key on C: 1

C: 60 - 71

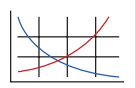

C: 30 - 31



C: 52 - 59

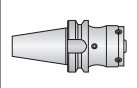

C: 72



ⓘ = Imperial (in)
 Ⓜ = Metric (mm)

Ring Style Mandrels

4335 Series | Short Length | Diameter Range: 0.6929" - 3.9602" (17.60 mm - 100.59 mm)

Series	4335
Shank Type	Modular
Application	Blind Holes
Coolant	Radial

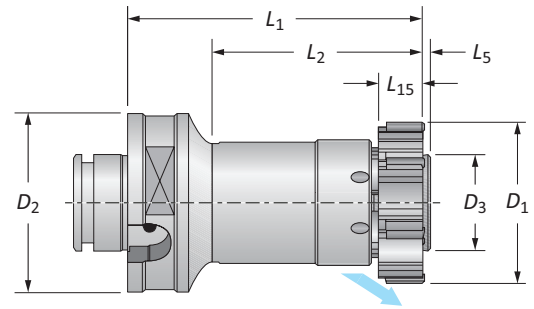

D_1 Range		Mandrel					Shank		Teeth	Part No. (Complete Mandrel*)
Imperial (inch)	Metric (mm)	D_3	L_5	L_{15}	L_2	L_1	D_2			
0.6929 - 0.8503	17.60 - 21.59	11.2	1	11	55	75	50	6	4335-MC-010	
0.8504 - 1.0078	21.60 - 25.59	11.2	1	12	55	75	50	6	4335-MC-020	
1.0079 - 1.1653	25.60 - 29.59	15.1	1	14	60	80	50	6	4335-MC-030	
1.1654 - 1.2834	29.60 - 32.59	15.1	1	14	60	80	50	6	4335-MC-035	
1.2835 - 1.4408	32.60 - 36.59	20.3	1	16	60	80	50	6	4335-MC-040	
1.4409 - 1.5983	36.60 - 40.59	20.3	1	16	60	80	50	6	4335-MC-045	
1.5984 - 1.7952	40.60 - 45.59	24.1	1	16	60	80	50	6	4335-MC-050	
m 1.7953 - 1.9527	45.60 - 49.59	27.9	1.5	18.5	60	80	50	6	4335-MC-060	
1.9528 - 2.1889	49.60 - 55.59	27.9	1.5	18.5	60	80	50	6	4335-MC-070	
2.1890 - 2.3857	55.60 - 60.59	27.9	1.5	18.5	60	80	50	6	4335-MC-075	
2.3858 - 2.5826	60.60 - 65.59	37.1	1.5	18.5	65	90	63	6	4335-MC-080	
2.5827 - 2.7794	65.60 - 70.59	37.1	1.5	18.5	65	90	63	6	4335-MC-085	
2.7795 - 3.1338	70.60 - 79.59	37.1	1.5	18.5	65	90	63	6	4335-MC-090	
3.1339 - 3.5668	79.60 - 90.59	53.1	1.5	18.5	65	90	63	8	4335-MC-100	
3.5669 - 3.9602	90.60 - 100.59	53.1	1.5	18.5	65	90	63	8	4335-MC-110	

*Complete mandrel does not include cutting ring.

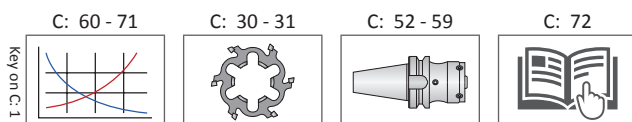

i = Imperial (in)
m = Metric (mm)

Ring Style Mandrels

4335 Series | Short Length | Spare Parts

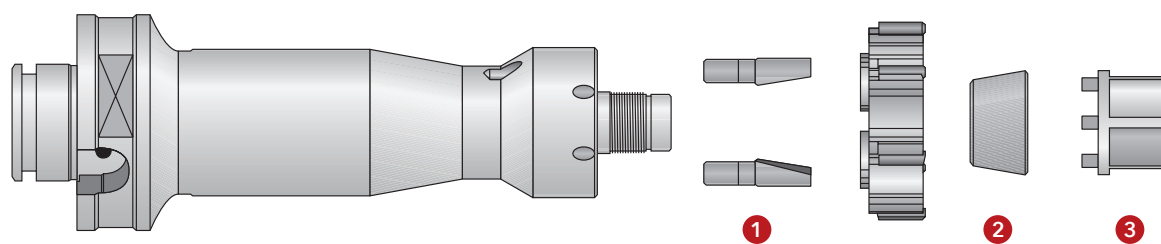

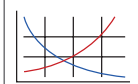

Part No. (Complete Mandrel*)	Spare Parts							Wrench Size (mm)
	1 Drive Pins	Number of Drive Pins	2 Conical Ring	Conical Ring (2nd Expansion)	Conical Ring (3rd Expansion)	3 Adjusting Key		
4335-MC-010	2000-CO-010	3	4001-AC-115	4001-AC-215	-	4001-CH-015	10	
4335-MC-020	2000-CO-020	3	4001-AC-115	4001-AC-215	-	4001-CH-015	10	
4335-MC-030	2000-CO-030	3	4001-AC-125	4001-AC-225	4001-AC-325	4001-CH-025	13	
4335-MC-035	2000-CO-040	2	4001-AC-125	4001-AC-225	4001-AC-325	4001-CH-025	13	
4335-MC-040	2000-CO-040	2	4001-AC-135	4001-AC-235	4001-AC-335	4001-CH-035	18	
4335-MC-045	2000-CO-050	2	4001-AC-135	4001-AC-235	4001-AC-335	4001-CH-035	18	
4335-MC-050	2000-CO-060	2	4001-AC-145	4001-AC-245	4001-AC-345	4001-CH-045	22	
4335-MC-060	2000-CO-060	2	4001-AC-155	4001-AC-255	4001-AC-355	4001-CH-055	26	
4335-MC-070	2000-CO-070	2	4001-AC-155	4001-AC-255	4001-AC-355	4001-CH-055	26	
4335-MC-075	2000-CO-080	2	4001-AC-155	4001-AC-255	4001-AC-355	4001-CH-055	26	
4335-MC-080	2000-CO-080	2	4001-AC-165	4001-AC-265	4001-AC-365	4001-CH-065	34	
4335-MC-085	2000-CO-090	2	4001-AC-165	4001-AC-265	4001-AC-365	4001-CH-065	34	
4335-MC-090	2000-CO-090	2	4001-AC-165	4001-AC-265	4001-AC-365	4001-CH-065	34	
4335-MC-100	2000-CO-090	2	4001-AC-185	4001-AC-285	4001-AC-385	4001-CH-085	46	
4335-MC-110	2000-CO-090	2	4001-AC-185	4001-AC-285	4001-AC-385	4001-CH-085	46	

*Complete mandrel does not include cutting ring.

C: 60 - 71  Key on C: 1

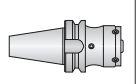
C: 30 - 31 

C: 52 - 59 

C: 72 

I = Imperial (in)
M = Metric (mm)

Ring Style Mandrels

4350 Series | Standard Length | Diameter Range: 0.6929" - 7.8972" (17.60 mm - 200.59 mm)

Series	4350
Shank Type	Modular
Application	Through Holes
Coolant	Radial

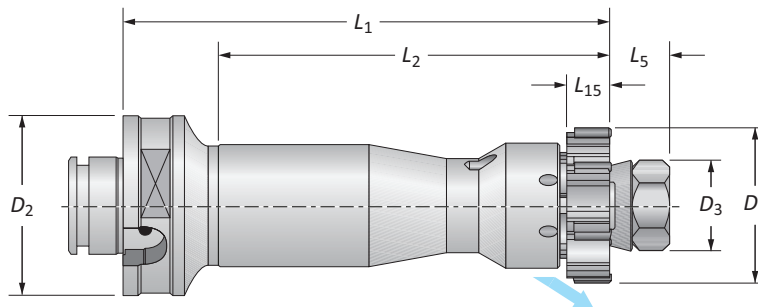

D_1 Range		Mandrel					Shank		Teeth	Part No. (Complete Mandrel*)
Imperial (inch)	Metric (mm)	D_3	L_5	L_{15}	L_2	L_1	D_2			
0.6929 - 0.8503	17.60 - 21.59	12	11	11	81	116	50	6	4350-MC-010	
0.8504 - 1.0078	21.60 - 25.59	12	11	12	81	116	50	6	4350-MC-020	
1.0079 - 1.2834	25.60 - 32.59	15.6	11	14	102	137	50	6	4350-MC-030	
1.2835 - 1.5983	32.60 - 40.59	22	14	16	102	137	50	6	4350-MC-040	
1.5984 - 1.7952	40.60 - 45.59	25.4	15	16	102	137	50	6	4350-MC-050	
1.7953 - 1.9527	45.60 - 49.59	30	20.5	18.5	105	140	50	6	4350-MC-060	
1.9528 - 2.3857	49.60 - 60.59	30	20.5	18.5	105	140	50	6	4350-MC-070	
2.3858 - 2.7794	60.60 - 70.59	40	24.5	18.5	105	140	63	6	4350-MC-080	
2.7795 - 3.1338	70.60 - 79.59	40	24.5	18.5	105	140	63	6	4350-MC-090	
3.1339 - 3.5668	79.60 - 90.59	56	28.5	18.5	105	140	63	8	4350-MC-100	
3.5669 - 3.9602	90.60 - 100.59	56	28.5	18.5	105	140	63	8	4350-MC-110	

*Complete mandrel does not include cutting ring.

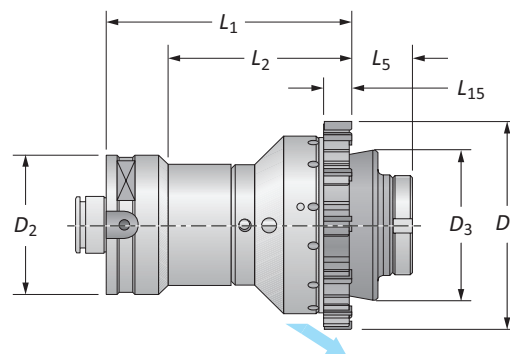

D_1 Range		Mandrel					Shank		Teeth	Part No. (Complete Mandrel*)
Imperial (inch)	Metric (mm)	D_3	L_5	L_{15}	L_2	L_1	D_2			
3.9603 - 4.3539	100.60 - 110.59	73.8	35.5	18.5	-	140	80	10	4350-MC-120	
4.3540 - 4.5508	110.60 - 115.59	80.8	35.5	18.5	-	140	80	12	4350-MC-130	
4.5509 - 4.7476	115.60 - 120.59	86.8	35.5	18.5	-	140	80	12	4350-MC-140	
4.7477 - 4.9445	120.60 - 125.59	86.8	35.5	18.5	-	140	80	12	4350-MC-150	
4.9446 - 5.2201	125.60 - 132.59	90.8	35.5	18.5	-	140	80	12	4350-MC-160	
5.2202 - 5.4957	132.60 - 139.59	90.8	35.5	18.5	-	140	80	12	4350-MC-170	
5.4958 - 5.7319	139.60 - 145.59	102.8	35.5	18.5	-	140	80	12	4350-MC-180	
5.7320 - 6.1256	145.60 - 155.59	107.8	35.5	18.5	-	140	80	12	4350-MC-190	
6.1257 - 6.5193	155.60 - 165.59	107.8	48.5	18.5	-	140	80	12	4350-MC-200	
6.5194 - 6.9130	165.60 - 175.59	117.8	48.5	18.5	-	140	80	12	4350-MC-210	
6.9131 - 7.3067	175.60 - 185.59	127.8	48.5	18.5	-	140	80	12	4350-MC-220	
7.3068 - 7.7004	185.60 - 195.59	137.8	48.5	18.5	-	140	80	12	4350-MC-230	
7.7005 - 7.8972	195.60 - 200.59	145.8	48.5	18.5	-	140	80	12	4350-MC-240	

*Complete mandrel does not include cutting ring.

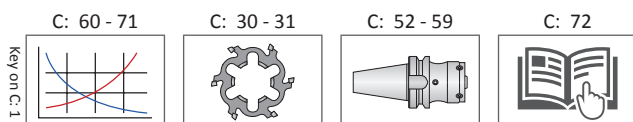

i = Imperial (in)
m = Metric (mm)

Ring Style Mandrels

4350 Series | Standard Length | Spare Parts

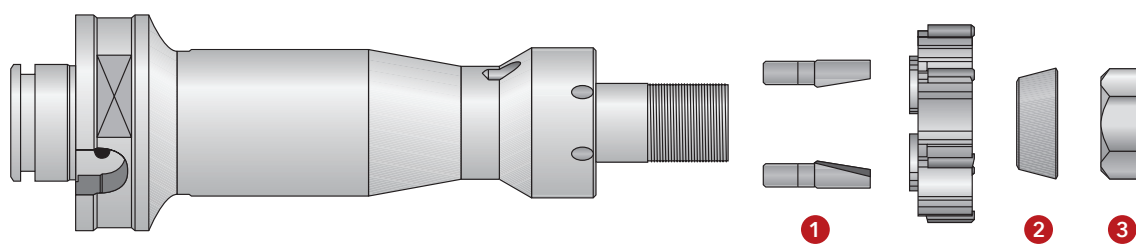

Part No. (Complete Mandrel*)	Spare Parts					Wrench Size (mm)
	1 Drive Pins	Number of Drive Pins	2 Conical Ring	3 Nut		
4350-MC-010	2000-CO-010	3	2010-AC-010	2000-DA-010	10	
4350-MC-020	2000-CO-020	3	2010-AC-010	2000-DA-010	10	
4350-MC-030	2000-CO-030	3	2010-AC-020	2000-DA-020	13	
4350-MC-040	2000-CO-040	2	2010-AC-030	2000-DA-060	19	
4350-MC-050	2000-CO-060	2	2010-AC-040	2000-DA-090	22	
4350-MC-060	2000-CO-060	2	2010-AC-050	2000-GH-880	30 ♦	
4350-MC-070	2000-CO-070	2	2010-AC-050	2000-GH-880	30 ♦	
4350-MC-080	2000-CO-080	2	2010-AC-060	2000-GH-900	40 ♦	
4350-MC-090	2000-CO-090	2	2010-AC-060	2000-GH-900	40 ♦	
4350-MC-100	2000-CO-090	2	2010-AC-070	2000-GH-920	56 ♦	
4350-MC-110	2000-CO-090	2	2010-AC-070	2000-GH-920	56 ♦	

*Complete mandrel does not include cutting ring.

♦ Spanner wrench

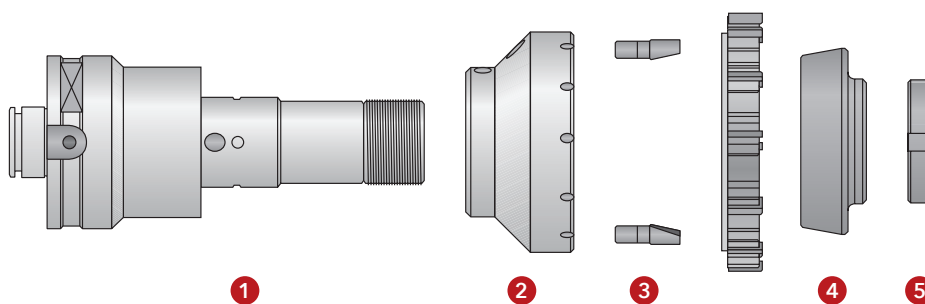

Part No. (Complete Mandrel*)	Spare Parts							Wrench Size (mm)
	1 Mandrel	2 Flange	3 Drive Pins	Number of Drive Pins	4 Conical Ring	5 Nut		
4350-MC-120	4350-MA-120	4355-FL-035	2000-CO-090	2	2060-BU-010	2000-GH-095	58 ♦	
4350-MC-130	4350-MA-120	4355-FL-045	2000-CO-090	2	2060-BU-020	2000-GH-095	58 ♦	
4350-MC-140	4350-MA-120	4355-FL-055	2000-CO-090	2	2060-BU-030	2000-GH-095	58 ♦	
4350-MC-150	4350-MA-120	4355-FL-065	2000-CO-090	2	2060-BU-030	2000-GH-095	58 ♦	
4350-MC-160	4350-MA-120	4355-FL-075	2000-CO-100	2	2060-BU-040	2000-GH-095	58 ♦	
4350-MC-170	4350-MA-120	4355-FL-085	2000-CO-100	2	2060-BU-040	2000-GH-095	58 ♦	
4350-MC-180	4350-MA-120	4355-FL-095	2000-CO-100	2	2060-BU-050	2000-GH-095	58 ♦	
4350-MC-190	4350-MA-120	4355-FL-105	2000-CO-110	2	2060-BU-060	2000-GH-095	58 ♦	
4350-MC-200	4350-MA-200	4355-FL-115	2000-CO-110	2	2060-BU-070	2000-GH-120	90 ♦	
4350-MC-210	4350-MA-200	4355-FL-125	2000-CO-110	2	2060-BU-080	2000-GH-120	90 ♦	
4350-MC-220	4350-MA-200	4355-FL-135	2000-CO-120	2	2060-BU-090	2000-GH-120	90 ♦	
4350-MC-230	4350-MA-200	4355-FL-145	2000-CO-120	2	2060-BU-100	2000-GH-120	90 ♦	
4350-MC-240	4350-MA-200	4355-FL-155	2000-CO-120	2	2060-BU-110	2000-GH-120	90 ♦	

*Complete mandrel does not include cutting ring.

♦ Spanner wrench

1 = Imperial (in)
M = Metric (mm)

Ring Style Mandrels

4355 Series | Standard Length | Diameter Range: 0.6929" - 7.8972" (17.60 mm - 200.59 mm)

Series	4355
Shank Type	Modular
Application	Blind Holes
Coolant	Radial

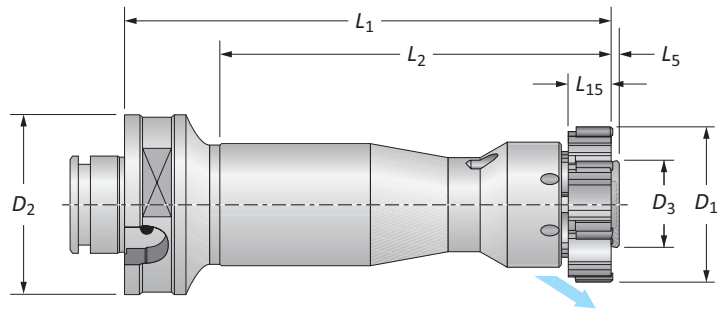

D ₁ Range		Mandrel					Shank		Teeth	Part No. (Complete Mandrel*)
Imperial (inch)	Metric (mm)	D ₃	L ₅	L ₁₅	L ₂	L ₁	D ₂			
0.6929 - 0.8503	17.60 - 21.59	11.2	1	11	81	116	50	6	4355-MC-010	
0.8504 - 1.0078	21.60 - 25.59	11.2	1	12	81	116	50	6	4355-MC-020	
1.0079 - 1.1653	25.60 - 29.59	15.1	1	14	102	137	50	6	4355-MC-030	
1.1654 - 1.2834	29.60 - 32.59	15.1	1	14	102	137	50	6	4355-MC-035	
1.2835 - 1.4408	32.60 - 36.59	20.3	1	16	102	137	50	6	4355-MC-040	
1.4409 - 1.5983	36.60 - 40.59	20.3	1	16	102	137	50	6	4355-MC-045	
1.5984 - 1.7952	40.60 - 45.59	24.1	1	16	102	137	50	6	4355-MC-050	
m 1.7953 - 1.9527	45.60 - 49.59	27.9	1.5	18.5	105	140	50	6	4355-MC-060	
1.9528 - 2.1889	49.60 - 55.59	27.9	1.5	18.5	105	140	50	6	4355-MC-070	
2.1890 - 2.3857	55.60 - 60.59	27.9	1.5	18.5	105	140	50	6	4355-MC-075	
2.3858 - 2.5826	60.60 - 65.59	37.1	1.5	18.5	105	140	63	6	4355-MC-080	
2.5827 - 2.7794	65.60 - 70.59	37.1	1.5	18.5	105	140	63	6	4355-MC-085	
2.7795 - 3.1338	70.60 - 79.59	37.1	1.5	18.5	105	140	63	6	4355-MC-090	
3.1339 - 3.5668	79.60 - 90.59	53.1	1.5	18.5	105	140	63	8	4355-MC-100	
3.5669 - 3.9602	90.60 - 100.59	53.1	1.5	18.5	105	140	63	8	4355-MC-110	

*Complete mandrel does not include cutting ring.

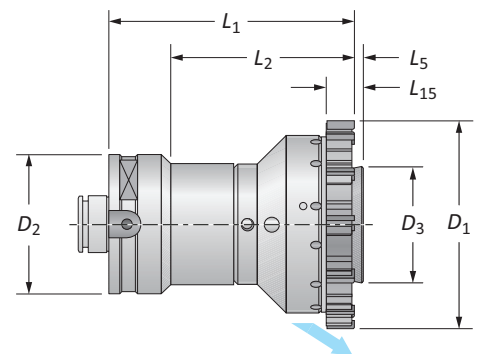

D ₁ Range		Mandrel					Shank		Teeth	Part No. (Complete Mandrel*)
Imperial (inch)	Metric (mm)	D ₃	L ₅	L ₁₅	L ₂	L ₁	D ₂			
3.9603 - 4.3539	100.60 - 110.59	70.3	1.5	18.5	-	140	80	10	4355-MC-120	
4.3540 - 4.5508	110.60 - 115.59	76.3	1.5	18.5	-	140	80	12	4355-MC-130	
4.5509 - 4.7476	115.60 - 120.59	83.3	1.5	18.5	-	140	80	12	4355-MC-140	
4.7477 - 4.9445	120.60 - 125.59	87.3	1.5	18.5	-	140	80	12	4355-MC-150	
4.9446 - 5.2201	125.60 - 132.59	87.3	1.5	18.5	-	140	80	12	4355-MC-160	
5.2202 - 5.4957	132.60 - 139.59	87.3	1.5	18.5	-	140	80	12	4355-MC-170	
m 5.4958 - 5.7319	139.60 - 145.59	99.3	1.5	18.5	-	140	80	12	4355-MC-180	
5.7320 - 6.1256	145.60 - 155.59	104.3	1.5	18.5	-	140	80	12	4355-MC-190	
6.1257 - 6.5193	155.60 - 165.59	104.3	1.5	18.5	-	140	80	12	4355-MC-200	
6.5194 - 6.9130	165.60 - 175.59	114.3	1.5	18.5	-	140	80	12	4355-MC-210	
6.9131 - 7.3067	175.60 - 185.59	124.3	1.5	18.5	-	140	80	12	4355-MC-220	
7.3068 - 7.7004	185.60 - 195.59	134.3	1.5	18.5	-	140	80	12	4355-MC-230	
7.7005 - 7.8972	195.60 - 200.59	142.3	1.5	18.5	-	140	80	12	4355-MC-240	

*Complete mandrel does not include cutting ring.

C: 60 - 71

C: 30 - 31

C: 52 - 59

C: 72

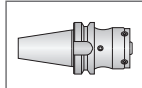
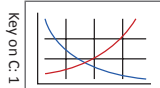

i = Imperial (in)
m = Metric (mm)

Ring Style Mandrels

4355 Series | Standard Length | Spare Parts

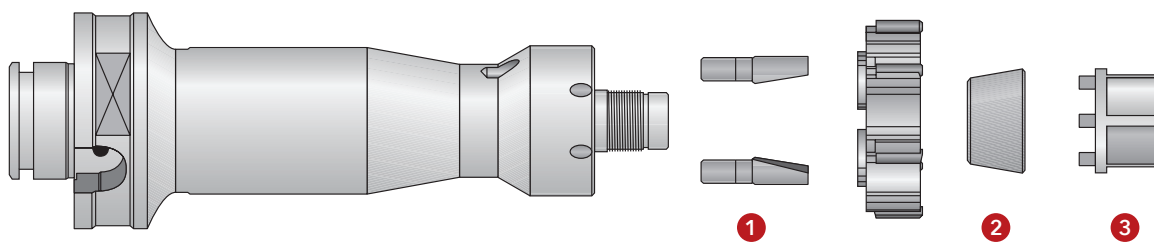

Part No. (Complete Mandrel*)	Spare Parts							Wrench Size (mm)
	1 Drive Pins	Number of Drive Pins	2 Conical Ring (2nd Expansion)	3 Conical Ring (3rd Expansion)	Adjusting Key			
4355-MC-010	2000-CO-010	3	4001-AC-115	4001-AC-215	-	4001-CH-015	10	
4355-MC-020	2000-CO-020	3	4001-AC-115	4001-AC-215	-	4001-CH-015	10	
4355-MC-030	2000-CO-030	3	4001-AC-125	4001-AC-225	4001-AC-325	4001-CH-025	13	
4355-MC-035	2000-CO-040	2	4001-AC-125	4001-AC-225	4001-AC-325	4001-CH-025	13	
4355-MC-040	2000-CO-040	2	4001-AC-135	4001-AC-235	4001-AC-335	4001-CH-035	18	
4355-MC-045	2000-CO-050	2	4001-AC-135	4001-AC-235	4001-AC-335	4001-CH-035	18	
4355-MC-050	2000-CO-060	2	4001-AC-145	4001-AC-245	4001-AC-345	4001-CH-045	22	
4355-MC-060	2000-CO-060	2	4001-AC-155	4001-AC-255	4001-AC-355	4001-CH-055	26	
4355-MC-070	2000-CO-070	2	4001-AC-155	4001-AC-255	4001-AC-355	4001-CH-055	26	
4355-MC-075	2000-CO-080	2	4001-AC-155	4001-AC-255	4001-AC-355	4001-CH-055	26	
4355-MC-080	2000-CO-080	2	4001-AC-165	4001-AC-265	4001-AC-365	4001-CH-065	34	
4355-MC-085	2000-CO-090	2	4001-AC-165	4001-AC-265	4001-AC-365	4001-CH-065	34	
4355-MC-090	2000-CO-090	2	4001-AC-165	4001-AC-265	4001-AC-365	4001-CH-065	34	
4355-MC-100	2000-CO-090	2	4001-AC-185	4001-AC-285	4001-AC-385	4001-CH-085	46	
4355-MC-110	2000-CO-090	2	4001-AC-185	4001-AC-285	4001-AC-385	4001-CH-085	46	

*Complete mandrel does not include cutting ring.

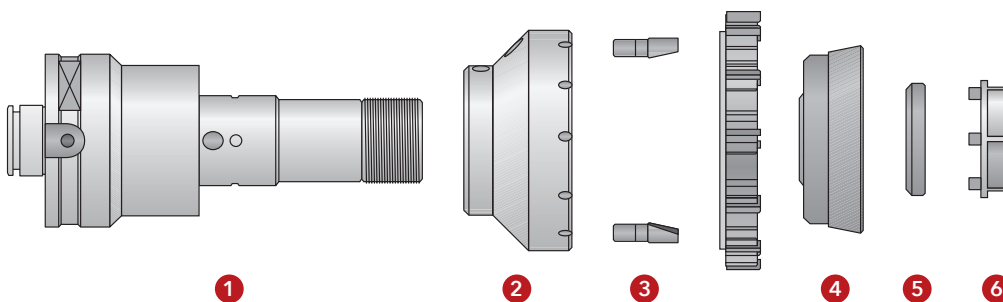

Part No. (Complete Mandrel*)	Spare Parts							Wrench Size (mm)
	1 Mandrel	2 Flange	3 Drive Pins	Number of Drive Pins	4 Conical Ring	5 Nut	6 Adjusting Key	
4355-MC-120	4355-MA-120	4355-FL-035	2000-CO-090	2	4001-AC-116	4001-GH-035	4001-CH-135	46
4355-MC-130	4355-MA-120	4355-FL-045	2000-CO-090	2	4001-AC-126	4001-GH-035	4001-CH-135	46
4355-MC-140	4355-MA-120	4355-FL-055	2000-CO-090	2	4001-AC-136	4001-GH-035	4001-CH-135	46
4355-MC-150	4355-MA-120	4355-FL-065	2000-CO-090	2	4001-AC-136	4001-GH-035	4001-CH-135	46
4355-MC-160	4355-MA-120	4355-FL-075	2000-CO-100	2	4001-AC-146	4001-GH-035	4001-CH-135	46
4355-MC-170	4355-MA-120	4355-FL-085	2000-CO-100	2	4001-AC-146	4001-GH-035	4001-CH-135	46
4355-MC-180	4355-MA-120	4355-FL-095	2000-CO-100	2	4001-AC-156	4001-GH-035	4001-CH-135	46
4355-MC-190	4355-MA-120	4355-FL-105	2000-CO-110	2	4001-AC-166	4001-GH-035	4001-CH-135	46
4355-MC-200	4355-MA-200	4355-FL-115	2000-CO-110	2	4001-AC-176	4001-GH-115	4001-CH-115	46
4355-MC-210	4355-MA-200	4355-FL-125	2000-CO-110	2	4001-AC-186	4001-GH-115	4001-CH-115	46
4355-MC-220	4355-MA-200	4355-FL-135	2000-CO-120	2	4001-AC-196	4001-GH-115	4001-CH-115	46
4355-MC-230	4355-MA-200	4355-FL-145	2000-CO-120	2	4001-AC-117	4001-GH-115	4001-CH-115	46
4355-MC-240	4355-MA-200	4355-FL-155	2000-CO-120	2	4001-AC-127	4001-GH-115	4001-CH-115	46

*Complete mandrel does not include cutting ring.

ⓘ = Imperial (in)
Ⓜ = Metric (mm)

Ring Style Mandrels

4300 Series | Long Length | Diameter Range: 0.6929" - 3.9602" (17.60 mm - 100.59 mm)

Series	4300
Shank Type	Modular
Application	Through Holes
Coolant	Radial

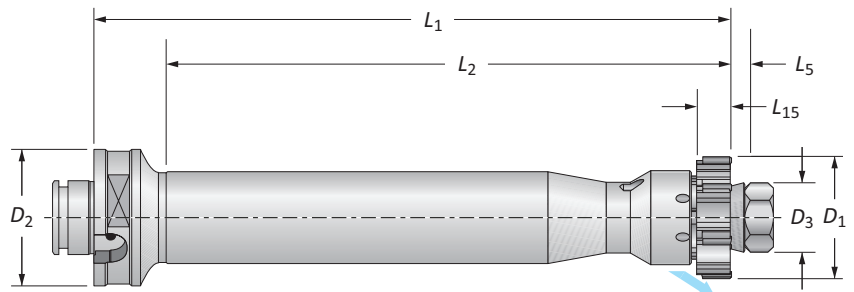

D ₁ Range		Mandrel							Teeth	Part No. (Complete Mandrel*)
Imperial (inch)	Metric (mm)	D ₃	L ₅	L ₁₅	L ₂	L ₁	D ₂			
0.6929 - 0.8503	17.60 - 21.59	12	11	11	121	156	50	6	4300-MC-010	
0.8504 - 1.0078	21.60 - 25.59	12	11	12	121	156	50	6	4300-MC-020	
1.0079 - 1.2834	25.60 - 32.59	15.6	11	14	153	188	50	6	4300-MC-030	
1.2835 - 1.5983	32.60 - 40.59	22	14	16	179	214	50	6	4300-MC-040	
1.5984 - 1.7952	40.60 - 45.59	25.4	15	16	201	236	50	6	4300-MC-050	
m 1.7953 - 1.9527	45.60 - 49.59	30	20.5	18.5	214	249	50	6	4300-MC-060	
1.9528 - 2.3857	49.60 - 60.59	30	20.5	18.5	214	249	50	6	4300-MC-070	
2.3858 - 2.7794	60.60 - 70.59	40	24.5	18.5	237	272	63	6	4300-MC-080	
2.7795 - 3.1338	70.60 - 79.59	40	24.5	18.5	237	272	63	6	4300-MC-090	
3.1339 - 3.5668	79.60 - 90.59	56	28.5	18.5	245	280	63	8	4300-MC-100	
3.5669 - 3.9602	90.60 - 100.59	56	28.5	18.5	245	280	63	8	4300-MC-110	

*Complete mandrel does not include cutting ring.

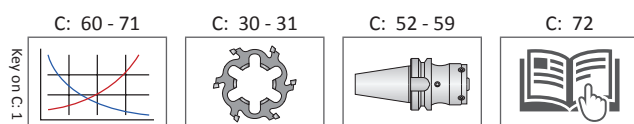

i = Imperial (in)
m = Metric (mm)

Ring Style Mandrels

4300 Series | Long Length | Spare Parts

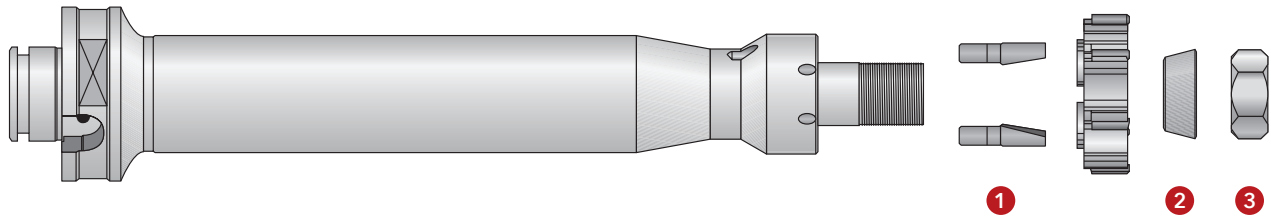

Part No. (Complete Mandrel*)	Spare Parts					Wrench Size (mm)
	1 Drive Pins	Number of Drive Pins	2 Conical Ring	3 Nut		
4300-MC-010	2000-CO-010	3	2010-AC-010	2000-DA-010	10	
4300-MC-020	2000-CO-020	3	2010-AC-010	2000-DA-010	10	
4300-MC-030	2000-CO-030	3	2010-AC-020	2000-DA-020	13	
4300-MC-040	2000-CO-040	2	2010-AC-030	2000-DA-060	19	
4300-MC-050	2000-CO-060	2	2010-AC-040	2000-DA-090	22	
4300-MC-060	2000-CO-060	2	2010-AC-050	2000-GH-880	30	
4300-MC-070	2000-CO-070	2	2010-AC-050	2000-GH-880	30	
4300-MC-080	2000-CO-080	2	2010-AC-060	2000-GH-900	40	
4300-MC-090	2000-CO-090	2	2010-AC-060	2000-GH-900	40	
4300-MC-100	2000-CO-090	2	2010-AC-070	2000-GH-920	56	
4300-MC-110	2000-CO-090	2	2010-AC-070	2000-GH-920	56	

*Complete mandrel does not include cutting ring.

Key on C: 1

C: 60 - 71

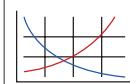

C: 30 - 31



C: 52 - 59

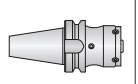

C: 72



i = Imperial (in)
m = Metric (mm)

Ring Style Mandrels

4305 Series | Long Length | Diameter Range: 0.6929" - 3.9602" (17.60 mm - 100.59 mm)

Series	4305
Shank Type	Modular
Application	Blind Holes
Coolant	Radial

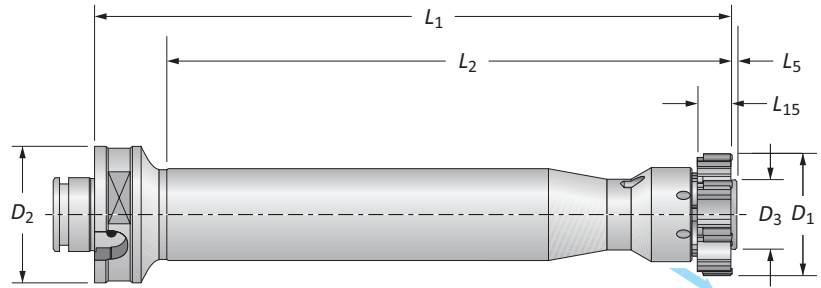

D_1 Range		Mandrel							Teeth	Part No. (Complete Mandrel*)
Imperial (inch)	Metric (mm)	D_3	L_5	L_{15}	L_2	L_1	D_2			
0.6929 - 0.8503	17.60 - 21.59	11.2	1	11	121	156	50	6	4305-MC-010	
0.8504 - 1.0078	21.60 - 25.59	11.2	1	12	121	156	50	6	4305-MC-020	
1.0079 - 1.1653	25.60 - 29.59	15.1	1	14	153	188	50	6	4305-MC-030	
1.1654 - 1.2834	29.60 - 32.59	15.1	1	14	153	188	50	6	4305-MC-035	
1.2835 - 1.4408	32.60 - 36.59	20.3	1	16	179	214	50	6	4305-MC-040	
1.4409 - 1.5983	36.60 - 40.59	20.3	1	16	179	214	50	6	4305-MC-045	
1.5984 - 1.7952	40.60 - 45.59	24.1	1	16	201	236	50	6	4305-MC-050	
m 1.7953 - 1.9527	45.60 - 49.59	27.9	1.5	18.5	214	249	50	6	4305-MC-060	
1.9528 - 2.1889	49.60 - 55.59	27.9	1.5	18.5	214	249	50	6	4305-MC-070	
2.1890 - 2.3857	55.60 - 60.59	27.9	1.5	18.5	214	249	50	6	4305-MC-075	
2.3858 - 2.5826	60.60 - 65.59	37.1	1	18.5	237	272	63	6	4305-MC-080	
2.5827 - 2.7794	65.60 - 70.59	37.1	1	18.5	237	272	63	6	4305-MC-085	
2.7795 - 3.1338	70.60 - 79.59	37.1	1	18.5	237	272	63	6	4305-MC-090	
3.1339 - 3.5668	79.60 - 90.59	53.1	1.5	18.5	245	280	63	8	4305-MC-100	
3.5669 - 3.9602	90.60 - 100.59	53.1	1.5	18.5	245	280	63	8	4305-MC-110	

*Complete mandrel does not include cutting ring.

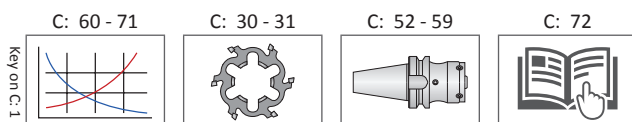

i = Imperial (in)
m = Metric (mm)

Ring Style Mandrels

4305 Series | Long Length | Spare Parts

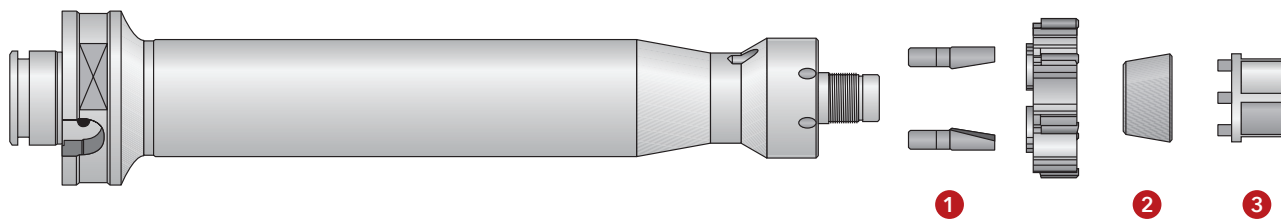

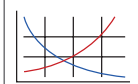

Part No. (Complete Mandrel*)	Spare Parts							Wrench Size (mm)
	1 Drive Pins	Number of Drive Pins	2 Conical Ring	Conical Ring (2nd Expansion)	Conical Ring (3rd Expansion)	3 Adjusting Key		
4305-MC-010	2000-CO-010	3	4001-AC-115	4001-AC-215	–	4001-CH-015	10	
4305-MC-020	2000-CO-020	3	4001-AC-115	4001-AC-215	–	4001-CH-015	10	
4305-MC-030	2000-CO-030	3	4001-AC-125	4001-AC-225	4001-AC-325	4001-CH-025	13	
4305-MC-035	2000-CO-040	2	4001-AC-125	4001-AC-225	4001-AC-325	4001-CH-025	13	
4305-MC-040	2000-CO-040	2	4001-AC-135	4001-AC-235	4001-AC-335	4001-CH-035	18	
4305-MC-045	2000-CO-050	2	4001-AC-135	4001-AC-235	4001-AC-335	4001-CH-035	18	
4305-MC-050	2000-CO-060	2	4001-AC-145	4001-AC-245	4001-AC-345	4001-CH-045	22	
4305-MC-060	2000-CO-060	2	4001-AC-155	4001-AC-255	4001-AC-355	4001-CH-055	26	
4305-MC-070	2000-CO-070	2	4001-AC-155	4001-AC-255	4001-AC-355	4001-CH-055	26	
4305-MC-075	2000-CO-080	2	4001-AC-155	4001-AC-255	4001-AC-355	4001-CH-055	26	
4305-MC-080	2000-CO-080	2	4001-AC-165	4001-AC-265	4001-AC-365	4001-CH-065	34	
4305-MC-085	2000-CO-090	2	4001-AC-165	4001-AC-265	4001-AC-365	4001-CH-065	34	
4305-MC-090	2000-CO-090	2	4001-AC-165	4001-AC-265	4001-AC-365	4001-CH-065	34	
4305-MC-100	2000-CO-090	2	4001-AC-185	4001-AC-285	4001-AC-385	4001-CH-085	46	
4305-MC-110	2000-CO-090	2	4001-AC-185	4001-AC-285	4001-AC-385	4001-CH-085	46	

*Complete mandrel does not include cutting ring.

C: 60 - 71  Key on C: 1

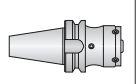
C: 30 - 31 

C: 52 - 59 

C: 72 

i = Imperial (in)
m = Metric (mm)

Radial Adjusting Shanks



Large range of shanks for different machine types



Highly adjustable for improved concentricity



All shanks are available with through coolant

All the Pieces You Need

Modular System courtesy of 

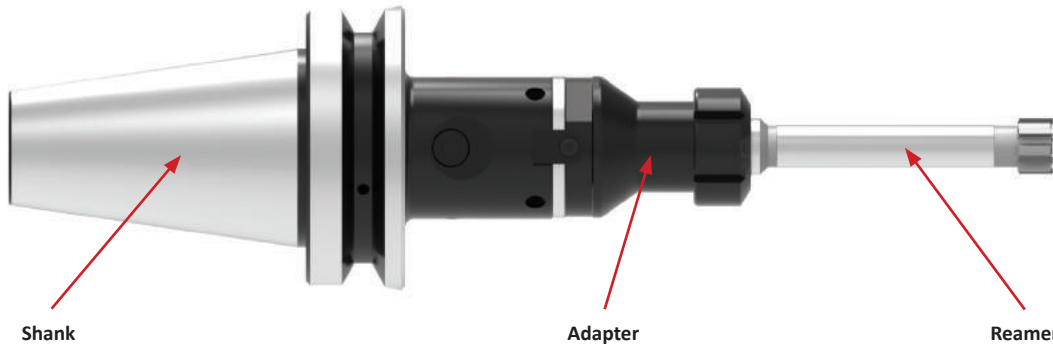

DIN 69871/1 B and A



HSK-A DIN 69893/1

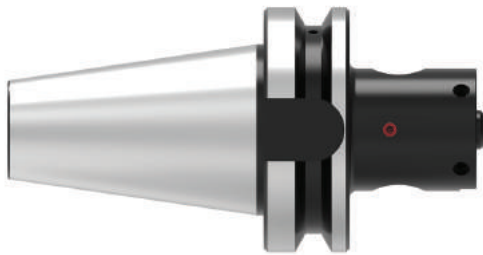

JMTBA MAS-403
BT B and BT



Straight



Collet Chuck Adapter



Cylindrical Shank Adapter

Radial Adjusting Shanks

Setup Information

Radial Adjusting Shanks and Ring Style Arbors

The following is a quick guide for setting up a radial adjusting shank and a ring style reamer. The ring reamer arbor does not contain the tang needed to connect to the shank. The tang must first be removed from the shank and then installed into the reamer arbor (demonstrated below).



Step 1:
The tang comes installed with the shank. Loosen the clamping screw on each side and remove the tang from the shank.



Step 2:
Thread the tang into the back end of the ring arbor. Use a bench vise and wrench to tighten.

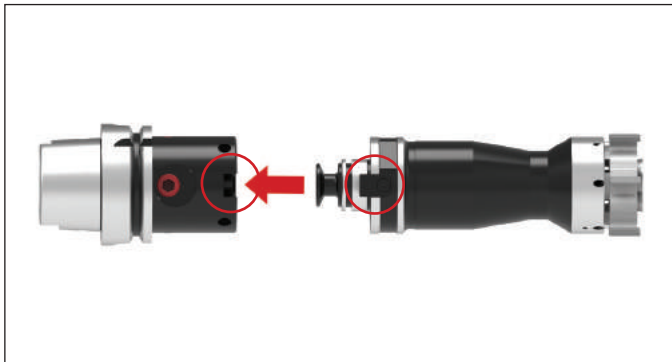

Step 3:
Assemble the ring arbor to the shank. With the clamping screws still loosened, align the key on the arbor to the keyway on the shank.



Step 4:
Once the ring arbor is connected with the shank, tighten the clamping screws to secure the tang back into place.

A

DRILLING

B

BORING

C

REAMING

D

BURNISHING

E

THREADING

X

SPECIALS

Radial Adjusting Shanks

DIN 69871/1 B and A

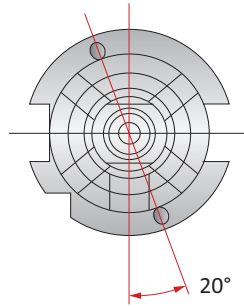

Maximum radial adjustment is ± 0.008 " (0.20 mm) on diameter

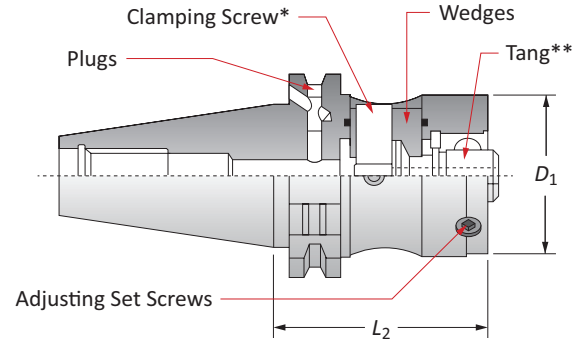

Shank				Spare Parts							
ISO Taper	D_1	L_2	Retention Knob Thread Size	Part No.	Wedges + O-Ring	Clamping Screw*	Adjusting Set Screws	Plugs	Replacement Tang**	Clamping Screw Key	
40	50	65	M16 x 2	02B.40.50L.65	ATR14102.2.3	ATR14102.1	M8x1x10G	M5x5TG	ATT14103	6 mm	
40	63	85	M16 x 2	02B.40.63L.85	ATR14108.2.3	ATR14108.1	M8x1x14G	M5x5TG	ATT14104	6 mm	
45	50	70	M20 x 2.5	02B.45.50L.70	ATR14102.2.3	ATR14102.1	M8x1x10G	M5x5TG	ATT14103	6 mm	
45	63	70	M20 x 2.5	02B.45.63L.70	ATR14108.2.3	ATR14108.1	M8x1x14G	M5x5TG	ATT14104	6 mm	
50	50	70	M24 x 3	02B.50.50L.70	ATR14102.2.3	ATR14102.1	M8x1x10G	M5x5TG	ATT14103	6 mm	
50	63	70	M24 x 3	02B.50.63L.70	ATR14108.2.3	ATR14108.1	M8x1x14G	M5x5TG	ATT14104	6 mm	
50	80	70	M24 x 3	❖ 02B.50.80L.70	ATR18775.2.3	ATR18775.1	M8x1x20G	M5x5TG	ATT14104	6 mm	

* Light torque exerted on the clamping screw transmits high axial forces, which provide stiffness and extreme accuracy to the assembly.

** Tang must be fitted to all reamer arbors and adapters prior to assembly.

❖ Could cause interference with tool changer mechanism.

NOTE: Shanks can be converted into DIN 69871/1A coolant by screwing the two plugs clockwise to the end of their stroke.

C: 53



Key on C: 1

Modular System courtesy of 

Reference Key

Symbol	Attribute
D_1	Modular shank size
L_2	Gage length

A DRILLING
B BORING
C REAMING
D BURNISHING
E THREADING
X SPECIALS

Radial Adjusting Shanks

JMTBA MAS-403 BT B and BT

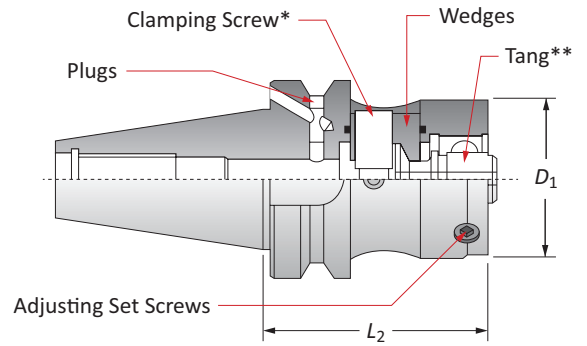
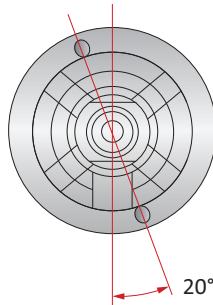

Maximum radial adjustment is $\pm 0.008''$ (0.20 mm) on diameter.

Shank				Spare Parts							
BT Taper	D_1	L_2	Retention Knob Thread Size	Part No.	Wedges + O-ring	Clamping Screw*	Adjusting Set Screws	Plugs	Replacement Tang**	Clamping Screw Key	
40	50	70	M16 x 2	BTB.40.50L.70	ATR14102.2.3	ATR14102.1	M8x1x10G	M5x5TG	ATT14103	6 mm	
40	63	80	M16 x 2	BTB.40.63L.80	ATR14108.2.3	ATR14108.1	M8x1x14G	M5x5TG	ATT14104	6 mm	
50	50	90	M24 x 3	BTB.50.50L.90	ATR14102.2.3	ATR14102.1	M8x1x10G	M5x5TG	ATT14103	6 mm	
50	63	90	M24 x 3	BTB.50.63L.90	ATR14108.2.3	ATR14108.1	M8x1x14G	M5x5TG	ATT14104	6 mm	
50	80	90	M24 x 3	BTB.50.80L.90	ATR18775.2.3	ATR18775.1	M8x1x20G	M5x5TG	ATT14104	6 mm	

* Light torque exerted on the clamping screw transmits high axial forces, which provide stiffness and extreme accuracy to the assembly.

** Tang must be fitted to all ring arbors and adapters prior to assembly.

NOTE: Shanks can be converted into MAS-403 BT coolant by screwing the two plugs clockwise to the end of their stroke.

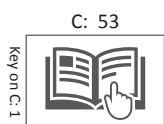

C: 53

Modular System courtesy of 

Reference Key	
Symbol	Attribute
D_1	Modular shank size
L_2	Gage length

Radial Adjusting Shanks

HSK-A DIN 69893/1

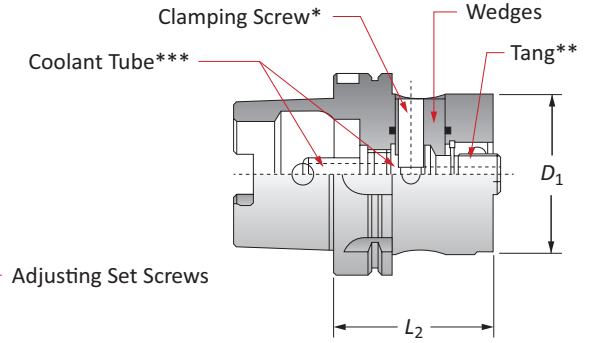
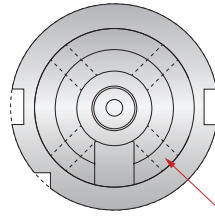
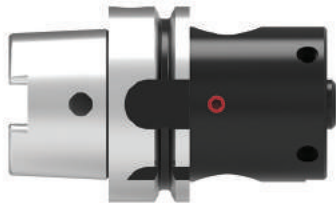

Shank			Spare Parts							
HSK	D_1	L_2	Part No.	Wedges + O-Ring	Clamping Screw*	Adjusting Set Screws	Replacement Tang**	Clamping Screw Key	Coolant Tube Key	Coolant Tube***
63	50	70	HSKA.63.50L.70	ATR14102.2.3	ATR14102.1	M8x1x10G	ATT14103	6 mm	ATR23856	ATT23728
63	63	75	HSKA.63.63L.75	ATR.41613.4	ATR14108.1	M8x1x14G	ATT14104	6 mm	ATR23856	ATT23728
100	50	80	HSKA.100.50L.80	ATR14102.2.3	ATR14102.1	M8x1x10G	ATT14103	6 mm	ATR23856	ATT23656
100	63	80	HSKA.100.63L.80	ATR14108.2.3	ATR14108.1	M8x1x14G	ATT14104	6 mm	ATR23856	ATT23656
100	80	80	HSKA.100.80L.80	ATR18775.2.3	ATR18775.1	M8x1x20G	ATT14104	6 mm	ATR23856	ATT23656

* Light torque exerted on the clamping screw transmits high axial forces, which provide stiffness and extreme accuracy to the assembly.

** Tang must be fitted to all ring arbors and adapters prior to assembly.

*** Coolant tube sold separately.

C: 53



Key on C: 1

Modular System courtesy of 

Reference Key

Symbol	Attribute
D_1	Modular shank size
L_2	Gage length

A DRILLING
B BORING
C REAMING
D BURNISHING
E THREADING
X SPECIALS

Radial Adjusting Shanks

Straight

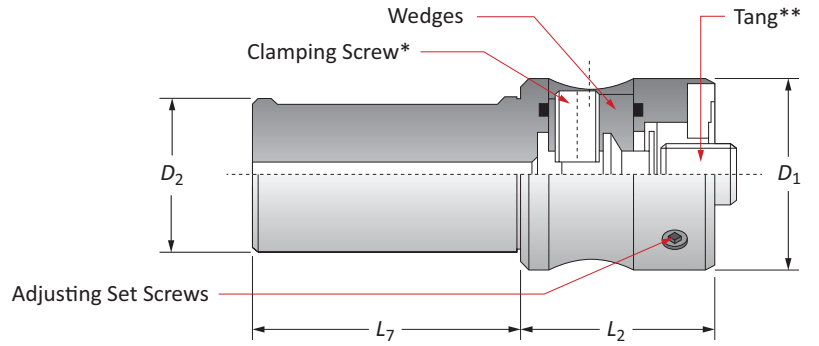

Shank				Spare Parts					
D_1	D_2	L_2	L_7	Part No.	Wedges + O-Ring	Clamping Screw*	Adjusting Set Screws	Replacement Tang**	Clamping Screw Key
50	25	50	70	CIL.25.50.50	ATR14102.2.3	ATR14102.1	M8x1x10G	ATT14103	6 mm
50	32	50	70	CIL.32.50.50	ATR14102.2.3	ATR14102.1	M8x1x10G	ATT14103	6 mm
50	40	50	70	CIL.40.50.50	ATR14102.2.3	ATR14102.1	M8x1x10G	ATT14103	6 mm

* Light torque exerted on the clamping screw transmits high axial forces, which provide stiffness and extreme accuracy to the assembly.

** Tang must be fitted to all ring arbors and adapters prior to assembly.

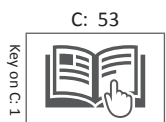

Modular System courtesy of 

Reference Key	
Symbol	Attribute
D_1	Modular shank size
D_2	Shank diameter
L_2	Gage length
L_7	Shank length

Radial Adjusting Adapters

Collet Chuck Adapters

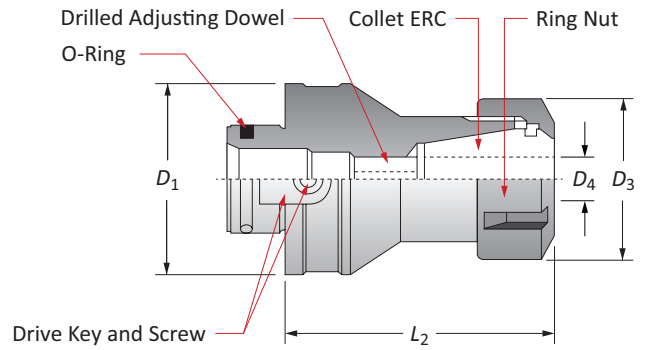

Collet Sleeve Size*	Adapter				Part No.	Spare Parts						
	D_1	D_3	D_4	L_2		Clamping Screw	Ring Nut	Adjusting Dowel	Drive Key	Ring Nut Wrench	Adjusting Dowel Key	
ERC25	50	42	0.5 - 16mm	70	30.50R.25.70	M4x8V	G25S	M12x16GF	TAB3924	CH25S	6 mm	
ERC32	50	50	1 - 20mm	70	30.50R.32.70	M4x8V	G32S	M16x15x18GF	TAB3924	CH32S	8 mm	
ERC32	63	50	1 - 20mm	90	30.63R.32.90	M6x12V	G32S	M12x16GF	TAB3923.1	CH32S	6 mm	
ERC40	63	63	2 - 30mm	90	30.63R.40.90	M6x12V	G40S	M20x2x20GF	TAB3923.1	CH40S	10 mm	
ERC32	80	50	1 - 20mm	90	30.80R.32.90	M6x16V	G32S	M12x16GF	TAB3923.2	CH32S	6 mm	
ERC40	80	63	2 - 30mm	90	30.80R.40.90	M6x16V	G40S	M20x2x20GF	TAB3923.2	CH40S	10 mm	

*Collet sleeve not included

Reference Key

Symbol	Attribute
D_1	Modular shank size
D_3	Body diameter
D_4	Shank diameter
L_2	Gage length

C: 53



Modular System courtesy of 

Radial Adjusting Adapters

Cylindrical Shank Adapters

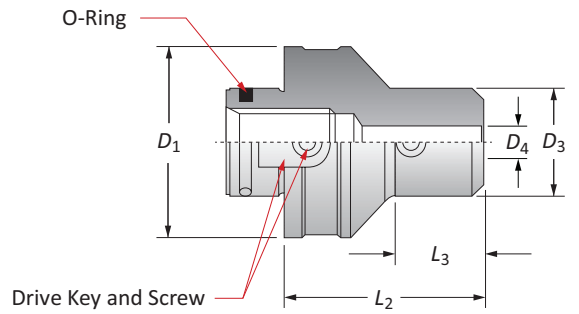

Adapter					Spare Parts				
D_1	D_4	D_3	L_2	L_3	Part No.	Drive Key	Screw	Set Screw	Set Screw Key
50	6	25	50	22.5	35.50R.06.50	TAB3924	M4x8V	M6x8G	3 mm
50	8	28	50	24.5	35.50R.08.50	TAB3924	M4x8V	M8x8G	4 mm
50	10	35	50	26.5	35.50R.10.50	TAB3924	M4x8V	M10x10G	5 mm
50	12	42	60	38.5	35.50R.12.60	TAB3924	M4x8V	M12x12G	6 mm
50	14	44	60	42	35.50R.14.60	TAB3924	M4x8V	M12x12G	6 mm
50	16	48	60	40	35.50R.16.60	TAB3924	M4x8V	M14x14G	6 mm
50	18	50	60	-	35.50R.18.60	TAB3924	M4x8V	M14x14G	6 mm
50	20	52	60	41	35.50R.20.60	TAB3924	M4x8V	M16x2x14G	8 mm
63	8	28	60	28	35.63R.08.60	TAB3923.1	M6x12V	M8x8G	4 mm
63	10	35	70	40	35.63R.10.70	TAB3923.1	M6x12V	M10x10G	5 mm
63	12	42	70	42	35.63R.12.70	TAB3923.1	M6x12V	M12x12G	6 mm
63	14	44	60	32	35.63R.14.60	TAB3923.1	M6x12V	M12x12G	6 mm
63	16	48	70	44	35.63R.16.70	TAB3923.1	M6x12V	M14x14G	6 mm
63	18	50	70	40	35.63R.18.70	TAB3923.1	M6x12V	M14x14G	6 mm
63	20	52	70	45	35.63R.20.70	TAB3923.1	M6x12V	M16x2x14G	8 mm
50	25	65	80	61	40.50R.25.80	TAB3924	M4x8V	M18x2x18G	8 mm
50	32	72	80	65	40.50R.32.80	TAB3924	M4x8V	M20x2x18G	10 mm
63	25	65	80	58	40.63R.25.80	TAB3923.1	M6x12V	M18x2x18G	8 mm
63	32	72	80	-	40.63R.32.80	TAB3923.1	M6x12V	M20x2x18G	10 mm
80	25	65	80	50.5	40.80R.25.80	TAB3923.2	M6x12V	M18x2x18G	8 mm
80	32	72	80	54	40.80R.32.80	TAB3923.2	M6x12V	M20x2x18G	10 mm

Reference Key	
Symbol	Attribute
D_1	Modular shank size
D_3	Body diameter
D_4	Shank diameter
L_2	Gage length
L_3	Reference length

C: 53



Modular System courtesy of 

Recommended Cutting Data | Imperial (inch)

Replaceable Head Style

ISO	Material	Hardness (BHN)	Speed (SFM)			Recommended Feed (IPR) by Reamer Diameter						
			Uncoated Carbide	Coated Carbide	Cermet	0.4646" - 0.8504"		0.8505" - 1.5590"		1.5591" - 2.3858"		
						Lead A, G	Lead E, N, M	Lead A, G	Lead E, N, M	Lead A, G	Lead E, N, M	
P	Free-Machining Steel 1118, 1215, 12L14, etc.	100 - 180 180 - 250	35 - 65 25 - 50	200 - 260 130 - 230	300 - 980 260 - 600	0.010 - 0.024 0.012 - 0.024	0.020 - 0.024 0.016 - 0.031	0.012 - 0.031 0.016 - 0.031	0.024 - 0.047 0.020 - 0.039	0.024 - 0.039 0.020 - 0.035	0.028 - 0.059 0.024 - 0.047	
	Low-Carbon Steel 1010, 1020, 1025, 1522, 1144, etc.	85 - 180 180 - 275	35 - 65 25 - 50	200 - 260 130 - 230	300 - 980 260 - 600	0.010 - 0.024 0.012 - 0.024	0.020 - 0.024 0.016 - 0.031	0.012 - 0.031 0.016 - 0.031	0.024 - 0.047 0.020 - 0.039	0.024 - 0.039 0.020 - 0.035	0.028 - 0.059 0.024 - 0.047	
	Medium-Carbon Steel 1030, 1040, 1050, 1527, 1140, 1151, etc.	125 - 180 180 - 325	35 - 65 25 - 50	200 - 260 130 - 230	300 - 980 260 - 600	0.010 - 0.024 0.012 - 0.024	0.020 - 0.024 0.016 - 0.031	0.012 - 0.031 0.016 - 0.031	0.024 - 0.047 0.020 - 0.039	0.024 - 0.039 0.020 - 0.035	0.028 - 0.059 0.024 - 0.047	
	Alloy Steel 4140, 5140, 8640, etc.	125 - 180 180 - 375	25 - 50 15 - 35	130 - 230 50 - 100	260 - 600 200 - 390	0.010 - 0.024 0.012 - 0.024	0.020 - 0.024 0.016 - 0.031	0.012 - 0.031 0.016 - 0.031	0.024 - 0.047 0.020 - 0.039	0.024 - 0.039 0.020 - 0.035	0.028 - 0.059 0.024 - 0.047	
	High-Strength Alloy 4340, 4330V, 300M, etc.	240 - 450	15 - 35	50 - 100	200 - 390	0.010 - 0.020	0.012 - 0.024	0.012 - 0.024	0.016 - 0.031	0.016 - 0.028	0.020 - 0.039	
	Structural Steel A36, A285, A516	125 - 180 180 - 350	35 - 65 25 - 50	200 - 260 130 - 230	300 - 980 260 - 600	0.010 - 0.024 0.012 - 0.024	0.020 - 0.024 0.016 - 0.031	0.012 - 0.031 0.016 - 0.031	0.024 - 0.047 0.020 - 0.039	0.024 - 0.039 0.020 - 0.035	0.028 - 0.059 0.024 - 0.047	
	Tool Steel H-13, H-21, A-4, O-2, S-3, etc.	150 - 200 200 - 250	35 - 65 25 - 50	200 - 260 130 - 230	300 - 980 260 - 600	0.010 - 0.024 0.012 - 0.024	0.020 - 0.024 0.016 - 0.031	0.012 - 0.031 0.016 - 0.031	0.024 - 0.047 0.020 - 0.039	0.024 - 0.039 0.020 - 0.035	0.028 - 0.059 0.024 - 0.047	
	S	High-Temp Alloy Hastelloy B, Inconel 600, etc.	140 - 310	20 - 50	60 - 200	-	0.008 - 0.016	-	0.012 - 0.020	-	0.016 - 0.024	-
		Titanium Alloy	140 - 310	20 - 50	60 - 200	-	0.008 - 0.016	-	0.012 - 0.020	-	0.016 - 0.024	-
	M	Stainless Steel 400 Series 416, 420, etc.	135 - 350	20 - 35	100 - 160	200 - 490	0.012 - 0.024	0.016 - 0.031	0.016 - 0.031	0.020 - 0.039	0.020 - 0.035	0.024 - 0.047
Stainless Steel 300 Series 304, 316, 17-4PH, etc.		135 - 275	20 - 35	100 - 160	200 - 490	0.012 - 0.024	0.016 - 0.031	0.016 - 0.031	0.020 - 0.039	0.020 - 0.035	0.024 - 0.047	
K	Grey Cast Iron, Ductile Cast Iron,	< 200	65 - 130	160 - 230	-	0.008 - 0.024	0.020 - 0.039	0.012 - 0.028	0.024 - 0.047	0.024 - 0.051	0.031 - 0.063	
	Spheroidal Cast Iron (Pearlitic)	> 200	50 - 100	160 - 230	-	0.008 - 0.024	0.020 - 0.039	0.012 - 0.028	0.024 - 0.047	0.024 - 0.051	0.031 - 0.063	
	Spheroidal Cast Iron (Ferritic)	260 - 320	30 - 50	100 - 160	200 - 400	0.008 - 0.024	0.020 - 0.024	0.012 - 0.028	0.024 - 0.047	0.016 - 0.031	0.031 - 0.063	
N	Copper and Alloys	< 500	200 - 660	330 - 660	-	0.008 - 0.024	-	0.012 - 0.028	-	0.016 - 0.031	-	
	Brass	< 180	65 - 130	260 - 520	330 - 980	0.012 - 0.024	0.016 - 0.039	0.012 - 0.024	0.020 - 0.047	0.012 - 0.024	0.024 - 0.059	
	Bronze	< 180	65 - 130	260 - 520	330 - 980	0.012 - 0.024	0.016 - 0.039	0.012 - 0.024	0.020 - 0.047	0.012 - 0.024	0.024 - 0.059	
	Bronze Phosphorous	< 150	65 - 660	-	-	0.012 - 0.024	-	0.016 - 0.039	-	0.016 - 0.039	-	

Formulas

<p>1. RPM = (SFM • 3.82) / DIA</p> <p>where:</p> <p>RPM = revolutions per minute (rev/min)</p> <p>SFM = speed (ft/min)</p> <p>DIA = diameter of reamer (inch)</p>	<p>2. IPM = RPM • IPR</p> <p>where:</p> <p>IPM = inches per minute (in/min)</p> <p>RPM = revolutions per minute (rev/min)</p> <p>IPR = feed rate (in/rev)</p>	<p>3. SFM = RPM • 0.262 • DIA</p> <p>where:</p> <p>SFM = speed (ft/min)</p> <p>RPM = revolutions per minute (rev/min)</p> <p>DIA = diameter of reamer (inch)</p>
--	--	---

IMPORTANT: The speeds and feeds listed on these pages are a general starting point for all applications. Factory technical assistance is also available for specific applications through our Application Engineering department. ext: 7611 | email: appeng@alliedmachine.com

Stock Allowance and Coolant | Imperial (inch)

Replaceable Head Style

ISO	Material	Hardness (BHN)	Coolant	Recommended Stock (inch) by Reamer Diameter*		
				0.4646" - 0.8504"	0.8505" - 1.5590"	1.5591" - 2.3858"
P	Free-Machining Steel 1118, 1215, 12L14, etc.	100 - 180	Water Soluble / Cutting Oil	0.006 - 0.010	0.008 - 0.016	0.012 - 0.016
		180 - 250				
	Low-Carbon Steel 1010, 1020, 1025, 1522, 1144, etc.	85 - 180				
		180 - 275				
	Medium-Carbon Steel 1030, 1040, 1050, 1527, 1140, 1151, etc.	125 - 180				
		180 - 325				
	Alloy Steel 4140, 5140, 8640, etc.	125 - 180				
		180 - 375				
	High-Strength Alloy 4340, 4330V, 300M, etc.	240 - 450				
S	High-Temp Alloy Hastelloy B, Inconel 600, etc.	140 - 310	Water Soluble / Cutting Oil	0.006 - 0.010	0.008 - 0.016	0.012 - 0.016
		140 - 310				
	Titanium Alloy	140 - 310				
M	Stainless Steel 400 Series 416, 420, etc.	135 - 350	Water Soluble / Cutting Oil	0.006 - 0.010	0.008 - 0.016	0.012 - 0.016
	Stainless Steel 300 Series 304, 316, 17-4PH, etc.	135 - 275				
K	Grey Cast Iron, Ductile Cast Iron,	< 200	Water Soluble / Cutting Oil	0.006 - 0.010	0.008 - 0.016	0.012 - 0.016
	Spheroidal Cast Iron (Pearlitic)	> 200				
	Spheroidal Cast Iron (Ferritic)	260 - 320				
N	Copper and Alloys	< 500	Water Soluble	0.006 - 0.010	0.008 - 0.016	0.012 - 0.016
	Brass					
	Bronze	< 180	Water Soluble / Cutting Oil			
	Bronze Phosphorous					
	Aluminum and Alloys	< 150	Water Soluble / Cutting Oil			

*Stock value is on diameter.

IMPORTANT: The speeds and feeds listed on these pages are a general starting point for all applications. Factory technical assistance is also available for specific applications through our Application Engineering department. ext: 7611 | email: appeng@alliedmachine.com

A
DRILLING
B
BORING
C
REAMING
D
BURNISHING
E
THREADING
X
SPECIALS

Recommended Cutting Data | Imperial (inch)

Monobloc Style

ISO	Material	Hardness (BHN)	Speed (SFM)			Recommended Feed (IPR) by Reamer Diameter						
			Uncoated Carbide	Coated Carbide	Cermet	0.2283" - 0.3940"		0.3941" - 0.7090"		0.7091" - 1.2638"		
						Lead A, G	Lead E, N, M	Lead A, G	Lead E, N, M	Lead A, G	Lead E, N, M	
P	Free-Machining Steel 1118, 1215, 12L14, etc.	100 - 180 180 - 250	25 - 50 20 - 35	200 - 260 130 - 230	300 - 980 260 - 660	0.008 - 0.016 0.008 - 0.016	0.012 - 0.024 0.012 - 0.020	0.016 - 0.024 0.012 - 0.024	0.016 - 0.047 0.012 - 0.031	0.020 - 0.031 0.016 - 0.028	0.024 - 0.047 0.016 - 0.047	
	Low-Carbon Steel 1010, 1020, 1025, 1522, 1144, etc.	85 - 180 180 - 275	25 - 50 20 - 35	200 - 260 130 - 230	300 - 980 260 - 660	0.008 - 0.016 0.008 - 0.016	0.012 - 0.024 0.012 - 0.020	0.016 - 0.024 0.012 - 0.024	0.016 - 0.047 0.012 - 0.031	0.020 - 0.031 0.016 - 0.028	0.024 - 0.047 0.016 - 0.047	
	Medium-Carbon Steel 1030, 1040, 1050, 1527, 1140, 1151, etc.	125 - 180 180 - 325	25 - 50 20 - 35	200 - 260 130 - 230	300 - 980 260 - 660	0.008 - 0.016 0.008 - 0.016	0.012 - 0.024 0.012 - 0.020	0.016 - 0.024 0.012 - 0.024	0.016 - 0.047 0.012 - 0.031	0.020 - 0.031 0.016 - 0.028	0.024 - 0.047 0.016 - 0.047	
	Alloy Steel 4140, 5140, 8640, etc.	125 - 180 180 - 375	20 - 35 15 - 25	130 - 230 100 - 160	260 - 660 200 - 490	0.008 - 0.016 0.008 - 0.016	0.012 - 0.024 0.012 - 0.020	0.016 - 0.024 0.012 - 0.024	0.016 - 0.047 0.012 - 0.031	0.020 - 0.031 0.016 - 0.028	0.024 - 0.047 0.016 - 0.047	
	High-Strength Alloy 4340, 4330V, 300M, etc.	240 - 450	10 - 20	50 - 100	200 - 390	0.006 - 0.012	0.008 - 0.016	0.008 - 0.020	0.012 - 0.024	0.012 - 0.024	0.016 - 0.031	
	Structural Steel A36, A285, A516	125 - 180 180 - 350	25 - 50 20 - 35	200 - 260 130 - 230	300 - 980 260 - 660	0.008 - 0.016 0.008 - 0.016	0.012 - 0.024 0.012 - 0.020	0.016 - 0.024 0.012 - 0.024	0.016 - 0.047 0.012 - 0.031	0.020 - 0.031 0.016 - 0.028	0.024 - 0.047 0.016 - 0.047	
	Tool Steel H-13, H-21, A-4, O-2, S-3, etc.	150 - 200 200 - 250	25 - 50 20 - 35	200 - 260 130 - 230	300 - 980 260 - 660	0.008 - 0.016 0.008 - 0.016	0.012 - 0.024 0.012 - 0.020	0.016 - 0.024 0.012 - 0.024	0.016 - 0.047 0.012 - 0.031	0.020 - 0.031 0.016 - 0.028	0.024 - 0.047 0.016 - 0.047	
	S	High-Temp Alloy Hastelloy B, Inconel 600, etc.	140 - 310	15 - 25	60 - 200	-	0.006 - 0.012	-	0.008 - 0.016	-	0.012 - 0.020	-
		Titanium Alloy	140 - 310	15 - 25	60 - 200	-	0.006 - 0.012	-	0.008 - 0.016	-	0.012 - 0.020	-
	M	Stainless Steel 400 Series 416, 420, etc.	135 - 350	15 - 25	100 - 160	200 - 490	0.008 - 0.016	0.012 - 0.020	0.012 - 0.024	0.012 - 0.031	0.016 - 0.028	0.016 - 0.047
Stainless Steel 300 Series 304, 316, 17-4PH, etc.		135 - 275	15 - 25	100 - 160	200 - 490	0.008 - 0.016	0.012 - 0.020	0.012 - 0.024	0.012 - 0.031	0.016 - 0.028	0.016 - 0.047	
K	Grey Cast Iron, Ductile Cast Iron, Spheroidal Cast Iron (Pearlitic)	< 200 > 200	50 - 100 35 - 65	160 - 230 160 - 230	- -	0.008 - 0.016 0.008 - 0.016	0.012 - 0.024 0.012 - 0.024	0.014 - 0.024 0.014 - 0.024	0.020 - 0.031 0.020 - 0.031	0.016 - 0.047 0.016 - 0.047	0.024 - 0.059 0.024 - 0.059	
	Spheroidal Cast Iron (Ferritic)	260 - 320	25 - 40	100 - 160	200 - 400	0.008 - 0.016	0.012 - 0.024	0.014 - 0.024	0.020 - 0.031	0.016 - 0.047	0.024 - 0.059	
	N	Copper and Alloys Brass	< 500	35 - 60	330 - 660	-	0.008 - 0.016	-	0.016 - 0.028	-	0.020 - 0.031	-
	Bronze Bronze Phosphorous	< 180	35 - 65	260 - 520	330 - 980	0.006 - 0.012	-	0.008 - 0.016	-	0.012 - 0.024	-	
	Aluminum and Alloys	< 150	50 - 100	330 - 660	-	0.008 - 0.016	-	0.016 - 0.028	-	0.020 - 0.031	-	

Formulas

<p>1. RPM = (SFM • 3.82) / DIA</p> <p>where:</p> <p>RPM = revolutions per minute (rev/min)</p> <p>SFM = speed (ft/min)</p> <p>DIA = diameter of reamer (inch)</p>	<p>2. IPM = RPM • IPR</p> <p>where:</p> <p>IPM = inches per minute (in/min)</p> <p>RPM = revolutions per minute (rev/min)</p> <p>IPR = feed rate (in/rev)</p>	<p>3. SFM = RPM • 0.262 • DIA</p> <p>where:</p> <p>SFM = speed (ft/min)</p> <p>RPM = revolutions per minute (rev/min)</p> <p>DIA = diameter of reamer (inch)</p>
--	--	---

IMPORTANT: The speeds and feeds listed on these pages are a general starting point for all applications. Factory technical assistance is also available for specific applications through our Application Engineering department. ext: 7611 | email: appeng@alliedmachine.com

Stock Allowance and Coolant | Imperial (inch)

Monobloc Style

ISO	Material	Hardness (BHN)	Coolant	Recommended Stock (inch) by Reamer Diameter*		
				0.2283" - 0.3940"	0.3941" - 0.7090"	0.7091" - 1.2638"
P	Free-Machining Steel 1118, 1215, 12L14, etc.	100 - 180	Water Soluble / Cutting Oil	0.006 - 0.012	0.008 - 0.016	0.010 - 0.020
		180 - 250				
	Low-Carbon Steel 1010, 1020, 1025, 1522, 1144, etc.	85 - 180				
		180 - 275				
	Medium-Carbon Steel 1030, 1040, 1050, 1527, 1140, 1151, etc.	125 - 180				
		180 - 325				
	Alloy Steel 4140, 5140, 8640, etc.	125 - 180				
		180 - 375				
	High-Strength Alloy 4340, 4330V, 300M, etc.	240 - 450				
S	High-Temp Alloy Hastelloy B, Inconel 600, etc.	140 - 310	Water Soluble / Cutting Oil	0.008 - 0.016	0.012 - 0.016	0.012 - 0.020
		140 - 310				
	Titanium Alloy	140 - 310				
M	Stainless Steel 400 Series 416, 420, etc.	135 - 350	Water Soluble / Cutting Oil	0.006 - 0.012	0.008 - 0.016	0.010 - 0.020
	Stainless Steel 300 Series 304, 316, 17-4PH, etc.	135 - 275				
K	Grey Cast Iron, Ductile Cast Iron,	< 200	Water Soluble / Cutting Oil	0.006 - 0.012	0.008 - 0.016	0.010 - 0.020
	Spheroidal Cast Iron (Pearlitic)	> 200				
	Spheroidal Cast Iron (Ferritic)	260 - 320				
N	Copper and Alloys	< 500	Water Soluble / Cutting Oil	0.006 - 0.012	0.008 - 0.016	0.010 - 0.020
	Brass	< 180				
	Bronze	< 180				
	Bronze Phosphorous	< 180				
	Aluminum and Alloys	< 150	Water Soluble / Cutting Oil			

*Stock value is on diameter.

IMPORTANT: The speeds and feeds listed on these pages are a general starting point for all applications. Factory technical assistance is also available for specific applications through our Application Engineering department. ext: 7611 | email: appeng@alliedmachine.com

A
DRILLING
B
BORING
C
REAMING
D
BURNISHING
E
THREADING
X
SPECIALS

Recommended Cutting Data | Imperial (inch)

Cutting Ring Style

ISO	Material	Hardness (BHN)	Speed (SFM)			Recommended Feed (IPR) by Reamer Diameter					
			Uncoated Carbide	Coated Carbide	Cermet	0.6929" - 1.5750"		1.5751" - 3.1500"		3.1501" - 7.8972"	
						Lead A, G	Lead E, N, M	Lead A, G	Lead E, N, M	Lead A, G	Lead E, N, M
P	Free-Machining Steel 1118, 1215, 12L14, etc.	100 - 180	25 - 50	200 - 260	300 - 980	0.020 - 0.031	0.024 - 0.047	0.020 - 0.039	0.031 - 0.063	0.031 - 0.059	0.039 - 0.087
		180 - 250	20 - 35	130 - 230	260 - 660	0.016 - 0.028	0.016 - 0.039	0.020 - 0.031	0.024 - 0.055	0.031 - 0.047	0.039 - 0.079
	Low-Carbon Steel 1010, 1020, 1025, 1522, 1144, etc.	85 - 180	25 - 50	200 - 260	300 - 980	0.020 - 0.031	0.024 - 0.047	0.020 - 0.039	0.031 - 0.063	0.031 - 0.059	0.039 - 0.087
		180 - 275	20 - 35	130 - 230	260 - 660	0.016 - 0.028	0.016 - 0.039	0.020 - 0.031	0.024 - 0.055	0.031 - 0.047	0.039 - 0.079
	Medium-Carbon Steel 1030, 1040, 1050, 1527, 1140, 1151, etc.	125 - 180	25 - 50	200 - 260	300 - 980	0.020 - 0.031	0.024 - 0.047	0.020 - 0.039	0.031 - 0.063	0.031 - 0.059	0.039 - 0.087
		180 - 325	20 - 35	130 - 230	260 - 660	0.016 - 0.028	0.016 - 0.039	0.020 - 0.031	0.024 - 0.055	0.031 - 0.047	0.039 - 0.079
	Alloy Steel 4140, 5140, 8640, etc.	125 - 180	20 - 35	130 - 230	260 - 660	0.020 - 0.031	0.024 - 0.047	0.020 - 0.039	0.031 - 0.063	0.031 - 0.059	0.039 - 0.087
		180 - 375	15 - 25	100 - 160	200 - 490	0.016 - 0.028	0.016 - 0.039	0.020 - 0.031	0.024 - 0.055	0.031 - 0.047	0.039 - 0.079
	High-Strength Alloy 4340, 4330V, 300M, etc.	240 - 450	10 - 20	50 - 100	200 - 390	0.012 - 0.024	0.016 - 0.031	0.016 - 0.031	0.020 - 0.039	0.024 - 0.039	0.028 - 0.055
	Structural Steel A36, A285, A516	125 - 180	25 - 50	200 - 260	300 - 980	0.020 - 0.031	0.024 - 0.047	0.020 - 0.039	0.031 - 0.063	0.031 - 0.059	0.039 - 0.087
		180 - 350	20 - 35	130 - 230	260 - 660	0.016 - 0.028	0.016 - 0.039	0.020 - 0.031	0.024 - 0.055	0.031 - 0.047	0.039 - 0.079
	Tool Steel H-13, H-21, A-4, O-2, S-3, etc.	150 - 200	25 - 50	200 - 260	300 - 980	0.020 - 0.031	0.024 - 0.047	0.020 - 0.039	0.031 - 0.063	0.031 - 0.059	0.039 - 0.087
		200 - 250	20 - 35	130 - 230	260 - 660	0.016 - 0.028	0.016 - 0.039	0.020 - 0.031	0.024 - 0.055	0.031 - 0.047	0.039 - 0.079
S	High-Temp Alloy Hastelloy B, Inconel 600, etc.	140 - 310	15 - 25	60 - 200	—	0.012 - 0.020	—	0.016 - 0.024	—	0.020 - 0.028	—
	Titanium Alloy	140 - 310	15 - 25	60 - 200	—	0.012 - 0.020	—	0.016 - 0.024	—	0.020 - 0.028	—
M	Stainless Steel 400 Series 416, 420, etc.	135 - 350	15 - 25	100 - 160	200 - 490	0.016 - 0.028	0.016 - 0.039	0.020 - 0.031	0.024 - 0.055	0.031 - 0.047	0.039 - 0.079
	Stainless Steel 300 Series 304, 316, 17-4PH, etc.	135 - 275	15 - 25	100 - 160	200 - 490	0.016 - 0.028	0.016 - 0.039	0.020 - 0.031	0.024 - 0.055	0.031 - 0.047	0.039 - 0.079
K	Grey Cast Iron, Ductile Cast Iron,	< 200	50 - 100	160 - 230	—	0.016 - 0.039	0.024 - 0.059	0.024 - 0.051	0.031 - 0.063	0.031 - 0.067	0.039 - 0.088
	Spheroidal Cast Iron (Pearlitic)	> 200	35 - 65	160 - 230	—	0.016 - 0.039	0.024 - 0.059	0.024 - 0.051	0.031 - 0.063	0.031 - 0.067	0.039 - 0.088
	Spheroidal Cast Iron (Ferritic)	260 - 320	25 - 40	100 - 160	200 - 400	0.016 - 0.039	0.024 - 0.059	0.024 - 0.051	0.031 - 0.063	0.031 - 0.067	0.039 - 0.088
N	Copper and Alloys	< 500	35 - 60	330 - 660	—	0.020 - 0.031	—	0.024 - 0.039	—	0.031 - 0.055	—
	Brass										
	Bronze	< 180	35 - 65	260 - 520	330 - 980	0.012 - 0.024	—	0.016 - 0.031	—	0.024 - 0.039	—
	Bronze Phosphorous										
	Aluminum and Alloys	< 150	50 - 100	330 - 660	—	0.020 - 0.031	—	0.024 - 0.039	—	0.031 - 0.055	—

Formulas

<p>1. RPM = (SFM • 3.82) / DIA</p> <p>where:</p> <p>RPM = revolutions per minute (rev/min)</p> <p>SFM = speed (ft/min)</p> <p>DIA = diameter of reamer (inch)</p>	<p>2. IPM = RPM • IPR</p> <p>where:</p> <p>IPM = inches per minute (in/min)</p> <p>RPM = revolutions per minute (rev/min)</p> <p>IPR = feed rate (in/rev)</p>	<p>3. SFM = RPM • 0.262 • DIA</p> <p>where:</p> <p>SFM = speed (ft/min)</p> <p>RPM = revolutions per minute (rev/min)</p> <p>DIA = diameter of reamer (inch)</p>
--	--	---

IMPORTANT: The speeds and feeds listed on these pages are a general starting point for all applications. Factory technical assistance is also available for specific applications through our Application Engineering department. ext: 7611 | email: appeng@alliedmachine.com

Stock Allowance and Coolant | Imperial (inch)

Cutting Ring Style

ISO	Material	Hardness (BHN)	Coolant	Recommended Stock (inch) by Reamer Diameter*		
				0.6929" - 1.5750"	1.5751" - 3.1500"	3.1501" - 7.8972"
P	Free-Machining Steel 1118, 1215, 12L14, etc.	100 - 180	Water Soluble / Cutting Oil	0.006 - 0.012	0.008 - 0.016	0.010 - 0.020
		180 - 250				
	Low-Carbon Steel 1010, 1020, 1025, 1522, 1144, etc.	85 - 180				
		180 - 275				
	Medium-Carbon Steel 1030, 1040, 1050, 1527, 1140, 1151, etc.	125 - 180				
		180 - 325				
	Alloy Steel 4140, 5140, 8640, etc.	125 - 180				
		180 - 375				
	High-Strength Alloy 4340, 4330V, 300M, etc.	240 - 450				
S	High-Temp Alloy Hastelloy B, Inconel 600, etc.	140 - 310	Water Soluble / Cutting Oil	0.008 - 0.016	0.012 - 0.016	0.012 - 0.020
		140 - 310				
	Titanium Alloy	140 - 310				
M	Stainless Steel 400 Series 416, 420, etc.	135 - 350	Water Soluble / Cutting Oil	0.006 - 0.012	0.008 - 0.016	0.010 - 0.020
	Stainless Steel 300 Series 304, 316, 17-4PH, etc.	135 - 275				
K	Grey Cast Iron, Ductile Cast Iron,	< 200	Water Soluble / Cutting Oil	0.006 - 0.012	0.008 - 0.016	0.010 - 0.020
	Spheroidal Cast Iron (Pearlitic)	> 200				
	Spheroidal Cast Iron (Ferritic)	260 - 320				
N	Copper and Alloys	< 500	Water Soluble / Cutting Oil	0.006 - 0.012	0.008 - 0.016	0.010 - 0.020
	Brass					
	Bronze	< 180				
	Bronze Phosphorous					
	Aluminum and Alloys	< 150	Water Soluble / Cutting Oil			

*Stock value is on diameter.

IMPORTANT: The speeds and feeds listed on these pages are a general starting point for all applications. Factory technical assistance is also available for specific applications through our Application Engineering department. ext: 7611 | email: appeng@alliedmachine.com

A
DRILLING
B
BORING
C
REAMING
D
BURNISHING
E
THREADING
X
SPECIALS

Recommended Cutting Data | Metric (mm)

Replaceable Head Style

ISO	Material	Hardness (BHN)	Speed (M/min)			Recommended Feed (mm/rev) by Reamer Diameter					
			Uncoated Carbide	Coated Carbide	Cermet	11.80 mm - 21.60 mm		21.61 mm - 39.60 mm		39.61 mm - 60.60 mm	
						Lead A, G	Lead E, N, M	Lead A, G	Lead E, N, M	Lead A, G	Lead E, N, M
P	Free-Machining Steel 1118, 1215, 12L14, etc.	100 - 180	10 - 20	60 - 80	90 - 300	0.25 - 0.60	0.50 - 0.60	0.30 - 0.80	0.60 - 1.20	0.60 - 1.00	0.70 - 1.50
		180 - 250	7 - 15	40 - 70	80 - 200	0.30 - 0.60	0.40 - 0.80	0.40 - 0.80	0.50 - 1.00	0.50 - 0.90	0.60 - 1.20
	Low-Carbon Steel 1010, 1020, 1025, 1522, 1144, etc.	85 - 180	10 - 20	60 - 80	90 - 300	0.25 - 0.60	0.50 - 0.60	0.30 - 0.80	0.60 - 1.20	0.60 - 1.00	0.70 - 1.50
		180 - 275	7 - 15	40 - 70	80 - 200	0.30 - 0.60	0.40 - 0.80	0.40 - 0.80	0.50 - 1.00	0.50 - 0.90	0.60 - 1.20
	Medium-Carbon Steel 1030, 1040, 1050, 1527, 1140, 1151, etc.	125 - 180	10 - 20	60 - 80	90 - 300	0.25 - 0.60	0.50 - 0.60	0.30 - 0.80	0.60 - 1.20	0.60 - 1.00	0.70 - 1.50
		180 - 325	7 - 15	40 - 70	80 - 200	0.30 - 0.60	0.40 - 0.80	0.40 - 0.80	0.50 - 1.00	0.50 - 0.90	0.60 - 1.20
	Alloy Steel 4140, 5140, 8640, etc.	125 - 180	6 - 10	40 - 70	80 - 200	0.25 - 0.60	0.50 - 0.60	0.30 - 0.80	0.60 - 1.20	0.60 - 1.00	0.70 - 1.50
		180 - 375	4 - 8	30 - 50	60 - 150	0.30 - 0.60	0.40 - 0.80	0.40 - 0.80	0.50 - 1.00	0.50 - 0.90	0.60 - 1.20
	High-Strength Alloy 4340, 4330V, 300M, etc.	240 - 450	3 - 6	15 - 30	60 - 120	0.25 - 0.50	0.30 - 0.60	0.30 - 0.60	0.40 - 0.80	0.40 - 0.70	0.50 - 1.00
S	High-Temp Alloy Hastelloy B, Inconel 600, etc.	140 - 310	4 - 10	30 - 50	–	0.20 - 0.40	–	0.30 - 0.50	–	0.40 - .060	–
	Titanium Alloy	140 - 310	4 - 15	30 - 50	–	0.20 - 0.40	–	0.30 - 0.50	–	0.40 - 0.60	–
M	Stainless Steel 400 Series 416, 420, etc.	135 - 350	4 - 10	30 - 50	60 - 150	0.30 - 0.60	0.40 - 0.80	0.40 - 0.80	0.50 - 1.00	0.50 - 0.90	0.60 - 1.20
	Stainless Steel 300 Series 304, 316, 17-4PH, etc.	135 - 275	4 - 10	30 - 50	60 - 150	0.30 - 0.60	0.40 - 0.80	0.40 - 0.80	0.50 - 1.00	0.50 - 0.90	0.60 - 1.20
K	Grey Cast Iron, Ductile Cast Iron,	< 200	20 - 40	50 - 70	–	0.20 - 0.60	0.50 - 1.00	0.30 - 0.70	0.60 - 1.20	0.60 - 1.30	0.80 - 1.60
	Spheroidal Cast Iron (Pearlitic)	> 200	15 - 30	50 - 70	–	0.20 - 0.60	0.50 - 1.00	0.30 - 0.70	0.60 - 1.20	0.60 - 1.30	0.80 - 1.60
	Spheroidal Cast Iron (Ferritic)	260 - 320	10 - 15	30 - 50	60 - 120	0.20 - 0.60	0.50 - 0.60	0.30 - 0.70	0.60 - 1.20	0.40 - 0.80	0.80 - 1.60
N	Copper and Alloys	< 500	60 - 200	100 - 200	–	0.20 - 0.60	–	0.30 - 0.70	–	0.40 - 0.80	–
	Brass										
	Bronze	< 180	20 - 40	80 - 160	100 - 300	0.30 - 0.60	0.40 - 1.00	0.30 - 0.60	0.50 - 1.20	0.30 - 0.60	0.60 - 1.50
	Bronze Phosphorous										
	Aluminum and Alloys	< 150	20 - 200	–	–	0.30 - 0.60	–	0.40 - 1.00	–	0.40 - 1.00	–

Formulas

<p>1. $RPM = M/min \cdot 3.82 \cdot DIA$</p> <p>where:</p> <ul style="list-style-type: none"> RPM = revolutions per minute (rev/min) M/min = speed (M/min) DIA = diameter of reamer (mm) 	<p>2. $mm/min = RPM \cdot mm/rev$</p> <p>where:</p> <ul style="list-style-type: none"> mm/min = mm per minute (mm/min) RPM = revolutions per minute (rev/min) mm/rev = feed rate (mm/rev) 	<p>3. $M/min = RPM \cdot 0.003 \cdot DIA$</p> <p>where:</p> <ul style="list-style-type: none"> M/min = speed (M/min) RPM = revolutions per minute (rev/min) DIA = diameter of reamer (mm)
--	---	---

IMPORTANT: The speeds and feeds listed on these pages are a general starting point for all applications. Factory technical assistance is also available for specific applications through our Application Engineering department. ext: 7611 | email: appeng@alliedmachine.com

Stock Allowance and Coolant | Metric (mm)

Replaceable Head Style

ISO	Material	Hardness (BHN)	Coolant	Recommended Stock (mm) by Reamer Diameter*		
				11.80 mm - 21.60 mm	21.61 mm - 39.60 mm	39.61 mm - 60.60 mm
P	Free-Machining Steel 1118, 1215, 12L14, etc.	100 - 180	Water Soluble / Cutting Oil	0.15 - 0.25	0.20 - 0.40	0.30 - 0.40
		180 - 250				
	Low-Carbon Steel 1010, 1020, 1025, 1522, 1144, etc.	85 - 180				
		180 - 275				
	Medium-Carbon Steel 1030, 1040, 1050, 1527, 1140, 1151, etc.	125 - 180				
		180 - 325				
	Alloy Steel 4140, 5140, 8640, etc.	125 - 180				
		180 - 375				
	High-Strength Alloy 4340, 4330V, 300M, etc.	240 - 450				
S	High-Temp Alloy Hastelloy B, Inconel 600, etc.	140 - 310	Water Soluble / Cutting Oil	0.15 - 0.25	0.20 - 0.40	0.30 - 0.40
		140 - 310				
	Titanium Alloy	140 - 310				
M	Stainless Steel 400 Series 416, 420, etc.	135 - 350	Water Soluble / Cutting Oil	0.15 - 0.25	0.20 - 0.40	0.30 - 0.40
	Stainless Steel 300 Series 304, 316, 17-4PH, etc.	135 - 275				
K	Grey Cast Iron, Ductile Cast Iron,	< 200	Water Soluble / Cutting Oil	0.15 - 0.25	0.20 - 0.40	0.30 - 0.40
	Spheroidal Cast Iron (Pearlitic)	> 200				
	Spheroidal Cast Iron (Ferritic)	260 - 320				
N	Copper and Alloys	< 500	Water Soluble / Cutting Oil	0.15 - 0.25	0.20 - 0.40	0.30 - 0.40
	Brass	< 180				
	Bronze	< 150				
	Bronze Phosphorous	< 150				
	Aluminum and Alloys	< 150				

*Stock value is on diameter.

IMPORTANT: The speeds and feeds listed on these pages are a general starting point for all applications. Factory technical assistance is also available for specific applications through our Application Engineering department. ext: 7611 | email: appeng@alliedmachine.com

A
DRILLING
B
BORING
C
REAMING
D
BURNISHING
E
THREADING
X
SPECIALS

Recommended Cutting Data | Metric (mm)

Monobloc Style

ISO	Material	Hardness (BHN)	Speed (M/min)			Recommended Feed (mm/rev) by Reamer Diameter					
			Uncoated Carbide	Coated Carbide	Cermet	5.80 mm - 10.00 mm		10.01 mm - 22.00 mm		22.01 mm - 32.10 mm	
						Lead A, G	Lead E, N, M	Lead A, G	Lead E, N, M	Lead A, G	Lead E, N, M
P	Free-Machining Steel 1118, 1215, 12L14, etc.	100 - 180	7 - 15	60 - 80	90 - 300	0.20 - 0.40	.30 - .60	0.40 - 0.60	0.40 - 1.00	0.50 - 0.80	0.60 - 1.20
		180 - 250	6 - 10	40 - 70	80 - 200	0.20 - 0.40	.30 - .50	0.30 - 0.60	0.30 - 0.80	0.40 - 0.70	0.40 - 1.00
	Low-Carbon Steel 1010, 1020, 1025, 1522, 1144, etc.	85 - 180	7 - 15	60 - 80	90 - 300	0.20 - 0.40	.30 - .60	0.40 - 0.60	0.40 - 1.00	0.50 - 0.80	0.60 - 1.20
		180 - 275	6 - 10	40 - 70	80 - 200	0.20 - 0.40	.30 - .50	0.30 - 0.60	0.30 - 0.80	0.40 - 0.70	0.40 - 1.00
	Medium-Carbon Steel 1030, 1040, 1050, 1527, 1140, 1151, etc.	125 - 180	7 - 15	60 - 80	90 - 300	0.20 - 0.40	.30 - .60	0.40 - 0.60	0.40 - 1.00	0.50 - 0.80	0.60 - 1.20
		180 - 325	6 - 10	40 - 70	80 - 200	0.20 - 0.40	.30 - .50	0.30 - 0.60	0.30 - 0.80	0.40 - 0.70	0.40 - 1.00
	Alloy Steel 4140, 5140, 8640, etc.	125 - 180	6 - 10	40 - 70	80 - 200	0.20 - 0.40	.30 - .60	0.40 - 0.60	0.40 - 1.00	0.50 - 0.80	0.60 - 1.20
		180 - 375	4 - 8	30 - 50	60 - 150	0.20 - 0.40	.30 - .50	0.30 - 0.60	0.30 - 0.80	0.40 - 0.70	0.40 - 1.00
	High-Strength Alloy 4340, 4330V, 300M, etc.	240 - 450	3 - 6	15 - 30	60 - 120	0.15 - 0.30	.20 - .40	0.20 - 0.50	0.30 - 0.60	0.30 - 0.60	0.40 - 0.80
S	High-Temp Alloy Hastelloy B, Inconel 600, etc.	140 - 310	4 - 10	30 - 50	-	0.15 - 0.30	-	0.20 - 0.40	-	0.30 - 0.50	-
	Titanium Alloy	140 - 310	4 - 15	30 - 50	-	0.15 - 0.30	-	0.20 - 0.40	-	0.30 - 0.50	-
M	Stainless Steel 400 Series 416, 420, etc.	135 - 350	4 - 10	30 - 50	60 - 150	0.20 - 0.40	.30 - .50	0.30 - 0.60	0.30 - 0.80	0.40 - 0.70	0.40 - 1.00
	Stainless Steel 300 Series 304, 316, 17-4PH, etc.	135 - 275	4 - 10	30 - 50	60 - 150	0.20 - 0.40	.30 - .50	0.30 - 0.60	0.30 - 0.80	0.40 - 0.70	0.40 - 1.00
K	Grey Cast Iron, Ductile Cast Iron,	< 200	15 - 30	50 - 70	-	0.20 - 0.40	.30 - .60	0.35 - 0.60	0.50 - 0.80	0.40 - 1.00	0.60 - 1.50
	Spheroidal Cast Iron (Pearlitic)	> 200	10 - 20	50 - 70	-	0.20 - 0.40	.30 - .60	0.35 - 0.60	0.50 - 0.80	0.40 - 1.00	0.60 - 1.50
	Spheroidal Cast Iron (Ferritic)	260 - 320	8 - 12	30 - 50	60 - 120	0.20 - 0.40	.30 - .60	0.35 - 0.60	0.50 - 0.80	0.40 - 1.00	0.60 - 1.50
N	Copper and Alloys	< 500	10 - 18	100 - 200	-	0.20 - 0.40	-	0.40 - 0.70	-	0.50 - 0.80	-
	Brass										
	Bronze	< 180	10 - 20	80 - 160	100 - 300	0.15 - 0.30	-	0.20 - 0.40	-	0.30 - 0.60	-
	Bronze Phosphorous										
	Aluminum and Alloys	< 150	15 - 30	100 - 200	-	0.20 - 0.40	-	0.40 - 0.70	-	0.50 - 0.80	-

Formulas

<p>1. $RPM = M/min \cdot 3.82 \cdot DIA$</p> <p>where:</p> <ul style="list-style-type: none"> RPM = revolutions per minute (rev/min) M/min = speed (M/min) DIA = diameter of reamer (mm) 	<p>2. $mm/min = RPM \cdot mm/rev$</p> <p>where:</p> <ul style="list-style-type: none"> mm/min = mm per minute (mm/min) RPM = revolutions per minute (rev/min) mm/rev = feed rate (mm/rev) 	<p>3. $M/min = RPM \cdot 0.003 \cdot DIA$</p> <p>where:</p> <ul style="list-style-type: none"> M/min = speed (M/min) RPM = revolutions per minute (rev/min) DIA = diameter of reamer (mm)
--	---	---

IMPORTANT: The speeds and feeds listed on these pages are a general starting point for all applications. Factory technical assistance is also available for specific applications through our Application Engineering department. ext: 7611 | email: appeng@alliedmachine.com

Stock Allowance and Coolant | Metric (mm)

Monobloc Style

ISO	Material	Hardness (BHN)	Coolant	Recommended Stock (mm) by Reamer Diameter*		
				5.80 mm - 10.00 mm	10.01 mm - 22.00 mm	22.01 mm - 32.10 mm
P	Free-Machining Steel 1118, 1215, 12L14, etc.	100 - 180	Water Soluble / Cutting Oil	0.08 - 0.15	0.15 - 0.25	0.15 - 0.30
		180 - 250				
	Low-Carbon Steel 1010, 1020, 1025, 1522, 1144, etc.	85 - 180				
		180 - 275				
	Medium-Carbon Steel 1030, 1040, 1050, 1527, 1140, 1151, etc.	125 - 180				
		180 - 325				
	Alloy Steel 4140, 5140, 8640, etc.	125 - 180				
		180 - 375				
	High-Strength Alloy 4340, 4330V, 300M, etc.	240 - 450				
S	High-Temp Alloy Hastelloy B, Inconel 600, etc.	140 - 310	Water Soluble / Cutting Oil	0.10 - 0.20	0.15 - 0.25	0.20 - 0.40
		140 - 310				
	Titanium Alloy	140 - 310				
M	Stainless Steel 400 Series 416, 420, etc.	135 - 350	Water Soluble / Cutting Oil	0.08 - 0.15	0.15 - 0.25	0.15 - 0.30
	Stainless Steel 300 Series 304, 316, 17-4PH, etc.	135 - 275				
K	Grey Cast Iron, Ductile Cast Iron,	< 200	Water Soluble / Cutting Oil	0.08 - 0.15	0.15 - 0.25	0.15 - 0.30
	Spheroidal Cast Iron (Pearlitic)	> 200				
	Spheroidal Cast Iron (Ferritic)	260 - 320				
N	Copper and Alloys	< 500	Water Soluble / Cutting Oil	0.08 - 0.15	0.15 - 0.25	0.15 - 0.30
	Brass	< 180				
	Bronze	< 180				
	Bronze Phosphorous	< 180				
	Aluminum and Alloys	< 150	Water Soluble / Cutting Oil			

*Stock value is on diameter.

IMPORTANT: The speeds and feeds listed on these pages are a general starting point for all applications. Factory technical assistance is also available for specific applications through our Application Engineering department. ext: 7611 | email: appeng@alliedmachine.com

A
DRILLING
B
BORING
C
REAMING
D
BURNISHING
E
THREADING
X
SPECIALS

Recommended Cutting Data | Metric (mm)

Cutting Ring Style

ISO	Material	Hardness (BHN)	Speed (M/min)			Recommended Feed (mm/rev) by Reamer Diameter					
			Uncoated Carbide	Coated Carbide	Cermet	17.60 mm - 40.00 mm		40.01 mm - 80.00 mm		80.01 mm - 200.00 mm	
						Lead A, G	Lead E, N, M	Lead A, G	Lead E, N, M	Lead A, G	Lead E, N, M
P	Free-Machining Steel 1118, 1215, 12L14, etc.	100 - 180	7 - 15	60 - 80	90 - 300	0.50 - 0.80	.60 - 1.20	0.50 - 1.00	0.80 - 1.60	0.80 - 1.50	1.00 - 2.20
		180 - 250	6 - 10	40 - 70	80 - 200	0.40 - 0.70	.40 - 1.00	0.50 - 0.80	0.60 - 1.40	0.80 - 1.20	1.00 - 2.00
	Low-Carbon Steel 1010, 1020, 1025, 1522, 1144, etc.	85 - 180	7 - 15	60 - 80	90 - 300	0.50 - 0.80	.60 - 1.20	0.50 - 1.00	0.80 - 1.60	0.80 - 1.50	1.00 - 2.20
		180 - 275	6 - 10	40 - 70	80 - 200	0.40 - 0.70	.40 - 1.00	0.50 - 0.80	0.60 - 1.40	0.80 - 1.20	1.00 - 2.00
	Medium-Carbon Steel 1030, 1040, 1050, 1527, 1140, 1151, etc.	125 - 180	7 - 15	60 - 80	90 - 300	0.50 - 0.80	.60 - 1.20	0.50 - 1.00	0.80 - 1.60	0.80 - 1.50	1.00 - 2.20
		180 - 325	6 - 10	40 - 70	80 - 200	0.40 - 0.70	.40 - 1.00	0.50 - 0.80	0.60 - 1.40	0.80 - 1.20	1.00 - 2.00
	Alloy Steel 4140, 5140, 8640, etc.	125 - 180	6 - 10	40 - 70	80 - 200	0.50 - 0.80	.60 - 1.20	0.50 - 1.00	0.80 - 1.60	0.80 - 1.50	1.00 - 2.20
		180 - 375	4 - 8	30 - 50	60 - 150	0.40 - 0.70	.40 - 1.00	0.50 - 0.80	0.60 - 1.40	0.80 - 1.20	1.00 - 2.00
	High-Strength Alloy 4340, 4330V, 300M, etc.	240 - 450	3 - 6	15 - 30	60 - 120	0.30 - 0.60	.40 - .80	0.40 - 0.80	0.50 - 1.00	0.60 - 1.00	0.70 - 1.40
S	High-Temp Alloy Hastelloy B, Inconel 600, etc.	140 - 310	4 - 8	30 - 50	-	0.30 - 0.50	-	0.40 - 0.60	-	0.50 - 0.70	-
	Titanium Alloy	140 - 310	4 - 8	30 - 50	-	0.30 - 0.50	-	0.40 - 0.60	-	0.50 - 0.70	-
M	Stainless Steel 400 Series 416, 420, etc.	135 - 350	4 - 8	30 - 50	60 - 150	0.40 - 0.70	.40 - 1.00	0.50 - 0.80	0.60 - 1.40	0.80 - 1.20	1.00 - 2.00
	Stainless Steel 300 Series 304, 316, 17-4PH, etc.	135 - 275	4 - 8	30 - 50	60 - 150	0.40 - 0.70	.40 - 1.00	0.50 - 0.80	0.60 - 1.40	0.80 - 1.20	1.00 - 2.00
K	Grey Cast Iron, Ductile Cast Iron,	< 200	15 - 30	50 - 70	-	0.40 - 1.00	.60 - 1.50	0.60 - 1.30	0.80 - 1.60	0.80 - 1.70	1.00 - 2.25
	Spheroidal Cast Iron (Pearlitic)	> 200	10 - 20	50 - 70	-	0.40 - 1.00	.60 - 1.50	0.60 - 1.30	0.80 - 1.60	0.80 - 1.70	1.00 - 2.25
	Spheroidal Cast Iron (Ferritic)	260 - 320	8 - 12	30 - 50	60 - 120	0.40 - 1.00	.60 - 1.50	0.60 - 1.30	0.80 - 1.60	0.80 - 1.70	1.00 - 2.25
N	Copper and Alloys	< 500	10 - 18	100 - 200	-	0.50 - 0.80	-	0.60 - 1.00	-	0.80 - 1.40	-
	Brass										
	Bronze	< 180	10 - 20	80 - 160	100 - 300	0.30 - 0.60	-	0.40 - 0.80	-	0.60 - 1.00	-
	Bronze Phosphorous										
	Aluminum and Alloys	< 150	15 - 30	100 - 200	-	0.50 - 0.80	-	0.60 - 1.00	-	0.80 - 1.40	-

Formulas

<p>1. $RPM = M/min \cdot 3.82 \cdot DIA$</p> <p>where:</p> <ul style="list-style-type: none"> RPM = revolutions per minute (rev/min) M/min = speed (M/min) DIA = diameter of reamer (mm) 	<p>2. $mm/min = RPM \cdot mm/rev$</p> <p>where:</p> <ul style="list-style-type: none"> mm/min = mm per minute (mm/min) RPM = revolutions per minute (rev/min) mm/rev = feed rate (mm/rev) 	<p>3. $M/min = RPM \cdot 0.003 \cdot DIA$</p> <p>where:</p> <ul style="list-style-type: none"> M/min = speed (M/min) RPM = revolutions per minute (rev/min) DIA = diameter of reamer (mm)
--	---	---

IMPORTANT: The speeds and feeds listed on these pages are a general starting point for all applications. Factory technical assistance is also available for specific applications through our Application Engineering department. ext: 7611 | email: appeng@alliedmachine.com

Stock Allowance and Coolant | Metric (mm)

Cutting Ring Style

ISO	Material	Hardness (BHN)	Coolant	Recommended Stock (mm) by Reamer Diameter*		
				17.60 mm - 40.00 mm	40.01 mm - 80.00 mm	80.01 mm - 200.00 mm
P	Free-Machining Steel 1118, 1215, 12L14, etc.	100 - 180	Water Soluble / Cutting Oil	0.15 - 0.30	0.20 - 0.40	0.25 - 0.50
		180 - 250				
	Low-Carbon Steel 1010, 1020, 1025, 1522, 1144, etc.	85 - 180				
		180 - 275				
	Medium-Carbon Steel 1030, 1040, 1050, 1527, 1140, 1151, etc.	125 - 180				
		180 - 325				
	Alloy Steel 4140, 5140, 8640, etc.	125 - 180				
		180 - 375				
	High-Strength Alloy 4340, 4330V, 300M, etc.	240 - 450				
S	High-Temp Alloy Hastelloy B, Inconel 600, etc.	140 - 310	Water Soluble / Cutting Oil	0.20 - 0.40	0.30 - 0.40	0.30 - 0.50
		140 - 310				
	Titanium Alloy	140 - 310				
M	Stainless Steel 400 Series 416, 420, etc.	135 - 350	Water Soluble / Cutting Oil	0.15 - 0.30	0.20 - 0.40	0.25 - 0.50
	Stainless Steel 300 Series 304, 316, 17-4PH, etc.	135 - 275				
K	Grey Cast Iron, Ductile Cast Iron,	< 200	Water Soluble / Cutting Oil	0.15 - 0.30	0.20 - 0.40	0.25 - 0.50
	Spheroidal Cast Iron (Pearlitic)	> 200				
	Spheroidal Cast Iron (Ferritic)	260 - 320				
N	Copper and Alloys	< 500	Water Soluble / Cutting Oil	0.15 - 0.30	0.20 - 0.40	0.25 - 0.50
	Brass					
	Bronze	< 180				
	Bronze Phosphorous					
	Aluminum and Alloys	< 150	Water Soluble / Cutting Oil			

*Stock value is on diameter.

IMPORTANT: The speeds and feeds listed on these pages are a general starting point for all applications. Factory technical assistance is also available for specific applications through our Application Engineering department. ext: 7611 | email: appeng@alliedmachine.com

A
DRILLING
B
BORING
C
REAMING
D
BURNISHING
E
THREADING
X
SPECIALS

Setup Information

Replaceable Head Style

A
DRILLING
B
BORING
C
REAMING
D
URNISHING
E
HREADING
X
PECIALS

Fixed Head Style

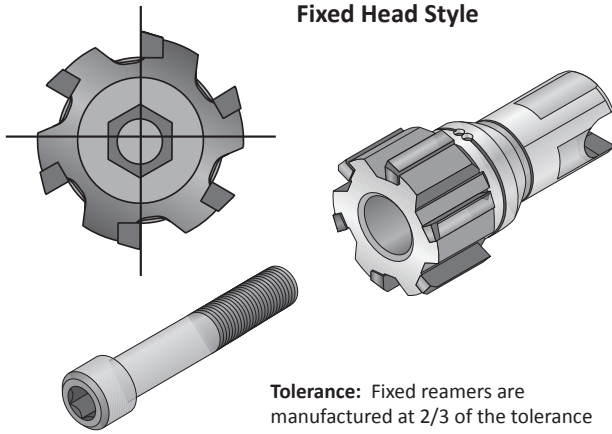

Tolerance: Fixed reamers are manufactured at 2/3 of the tolerance

Recommended Tightening Torque for Fixed Head Reamer (7400 / 7700)

Imperial		Metric	
D ₁ Range (inch)	Torque (in-lbs)	D ₁ Range (mm)	Torque (N-m)
0.465 - 0.575	22.1	11.80 - 14.60	2.5
0.575 - 0.693	33.6	14.61 - 17.60	3.5
0.693 - 0.850	44.3	17.61 - 21.60	5.0
0.851 - 1.047	62.0	21.61 - 26.60	7.0
1.048 - 1.283	88.5	26.61 - 32.60	10.0
1.284 - 1.598	106.2	32.61 - 40.60	12.0
1.599 - 1.992	141.6	40.61 - 50.60	16.0
1.993 - 2.386	177.0	50.61 - 60.60	20.0

Expandable Head Style

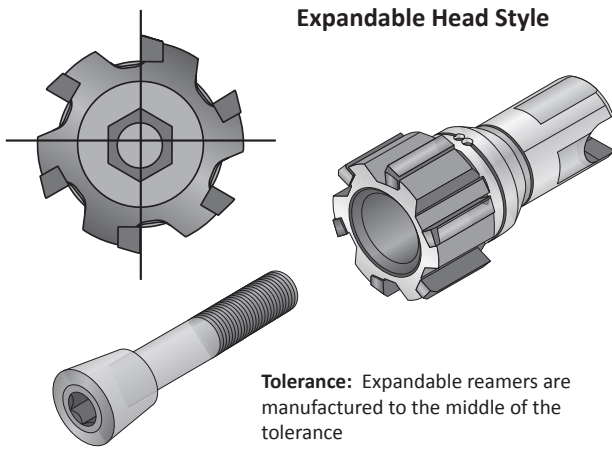

Tolerance: Expandable reamers are manufactured to the middle of the tolerance

Expanding Heads Adjustment

When the size reaches its lower tolerance, the head can be adjusted to compensate for wear to the cutting edges. This operation can be repeated several times until the surface finish of the hole deteriorates to an unacceptable level.

Adjustment Procedure

Slowly turn the right-hand threaded screw clockwise while checking the diameter setting of the reamer with a micrometer. When the required diameter is achieved, the tool is ready for use.

Replaceable Head Reamer Assembly

Fixed and Expandable Styles

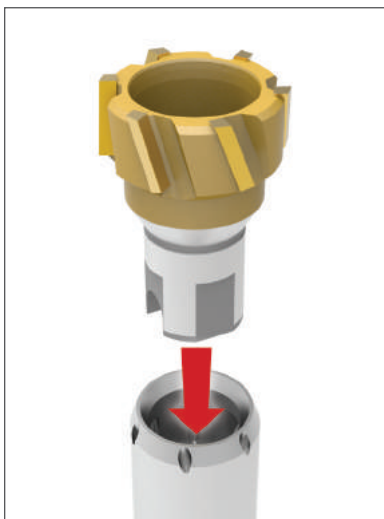

Step 1: Insert the replaceable reamer head into the mandrel.

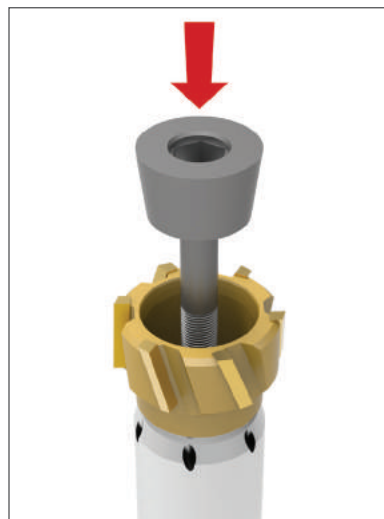

Step 2: Insert the screw into the reamer head opening to secure it to the mandrel.

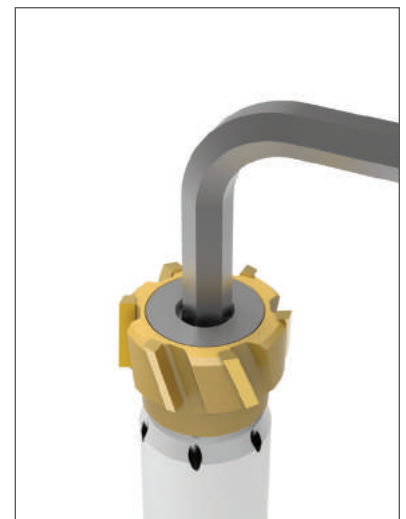

Step 3: Tighten the screw.

NOTE: We recommend lubricating the thread and the conical surface of contact between the reamer head and the screw with antifriction Molycote® grease.

Setup Information

Monobloc Style

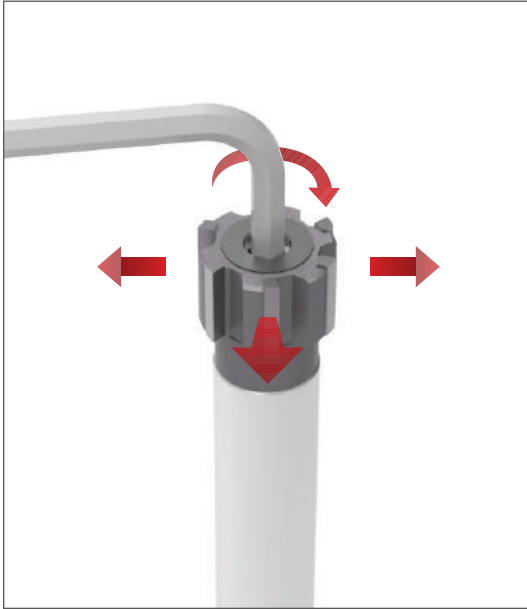

Tolerance

All monobloc reamers are ground to the requested diameter and set in the middle of the hole tolerance ready for use.

Adjustment

The adjustment must be made to compensate for wear to the cutting edges when the size reaches its lower tolerance. This operation can be repeated several times until the surface finish of the hole deteriorates to an unacceptable level. Then the reamer must be reground. The maximum expansion is about 1% of the diameter.

A

DRILLING

B

BORING

C

REAMING

D

BURNISHING

E

THREADING

X

SPECIALS

Setup Information

Cutting Ring Style

Drive Pin
(11:00 position)

Dimples
(12:00 position)

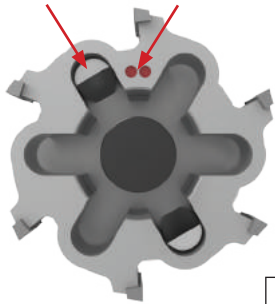

Step 1:
With the drive pins assembled, insert the cutting ring onto the mandrel. Make sure the dimples are at the 12:00 position with the drive pin at the 11:00 position.

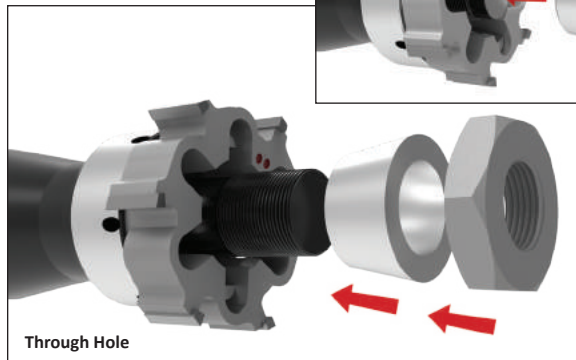
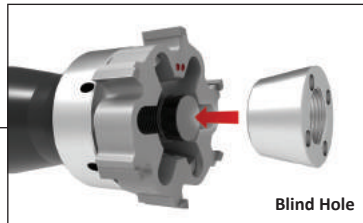

Adjustment Procedure

1. Turn the conical ring slowly using an adjustment key (left-hand thread). Adjustment keys are supplied with reamers from diameter 17.60 mm to 40.59 mm.
2. Check the diameter setting of the cutting ring with a micrometer.
3. When the required diameter is achieved, unscrew the conical ring until there is a click and the drive pins are in traction in the opposite direction to the cutting action of the reamer. The reamer is ready for use.

Step 2:

Insert the conical ring. Tighten the lock nut to set the desired reamer size (left-hand thread). Then loosen the lock nut slightly until it "clicks" against the drive wall.

NOTE: We recommend lubricating the thread and the conical surface of contact between the cutting ring and the conical ring with antifriction Molycote® grease.

For Diameter Range: 100.60 mm - 200.59 mm

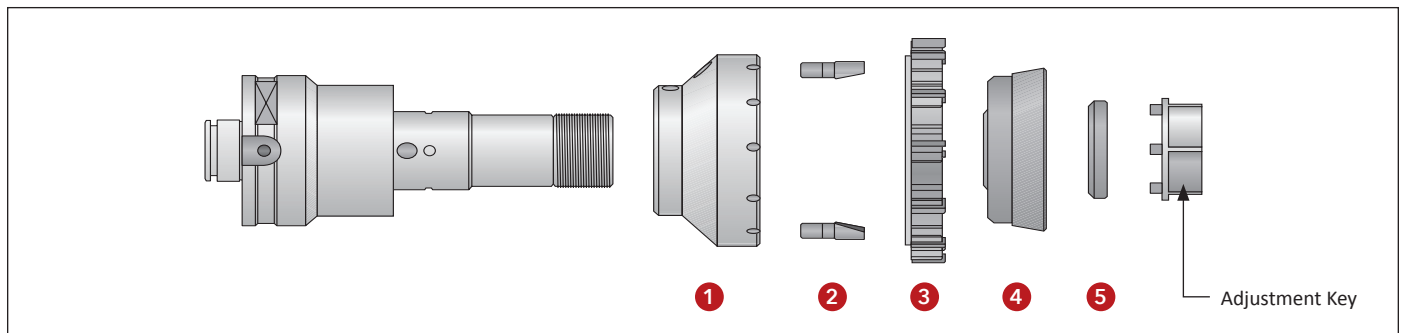

Assembly

1. With the drive pins (2) assembled, mount the flange (1) onto the mandrel. Assemble the cutting ring (3) so the slot on the left side of the dimple is mounted onto the drive pins (2). Insert the conical ring (4).
2. Screw the ring nut (5) onto the mandrel and tighten manually so the conical ring (4) makes contact with the cutting ring (3). The thread is left handed.

NOTE: We recommend lubricating the thread and the conical surface of contact between the cutting ring and the conical ring with antifriction Molycote grease.

Adjustment Procedure

1. Turn the ring nut (5) slowly using a pin spanner.
2. Check the diameter setting of the cutting ring with a micrometer. Make sure the drive pins (2) are in traction and in the opposite direction of the cutting action of the reamer.
3. When the required diameter is achieved, the tool is ready to use.

Diameter Measurement

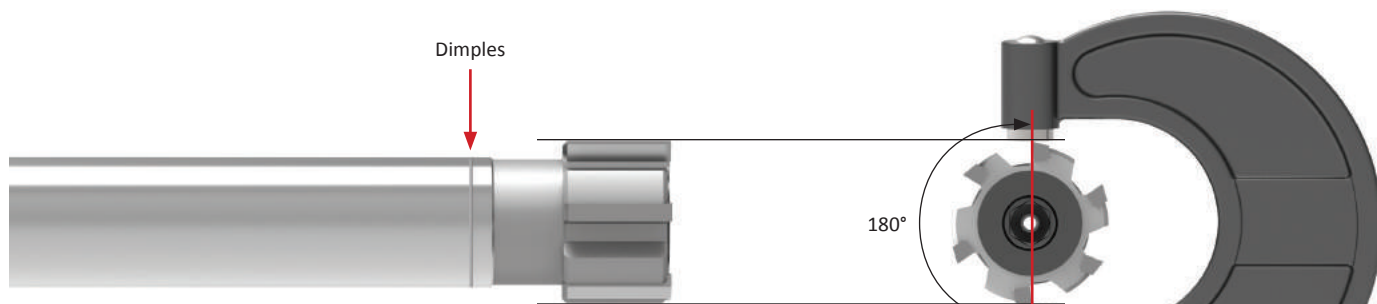

Using the Measuring Teeth

With the reamer assembled, use a presetter or micrometers to measure the reamer diameter using the opposing 180° teeth. A presetter (with at least 2 μm resolution) is preferred to avoid chipping the cutting edges.

NOTE: Only two cutting teeth are 180° opposed. The asymmetric spacing of the other cutting teeth will not induce harmonics, which prevents the tool from creating chatter.

The red dimples indicate which two opposing teeth are the measuring teeth. All S.C.A.M.I. Reamers have a dimple to indicate the 180° opposing teeth.

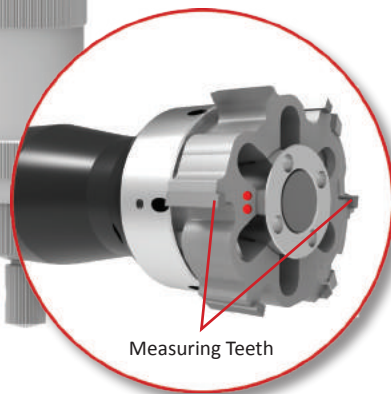
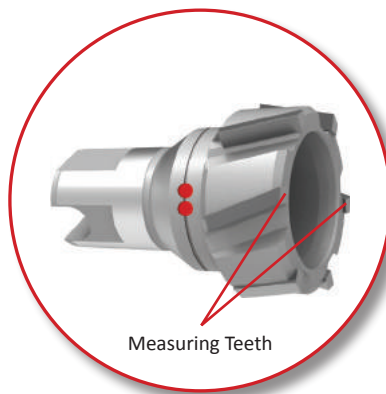
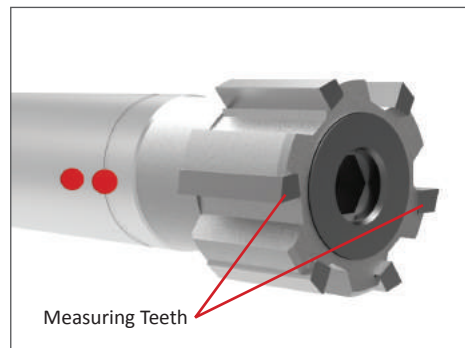

Where to Take the Measurement

When measuring the diameter, take the measurement from the area of the cutting tooth just below the transition from the lead angle to the OD edge. See the illustration below.

The back side of the OD edge has a back taper. This is why measuring from the location just below the lead angle/OD edge transition point results in the most accurate measurement (before the taper begins).

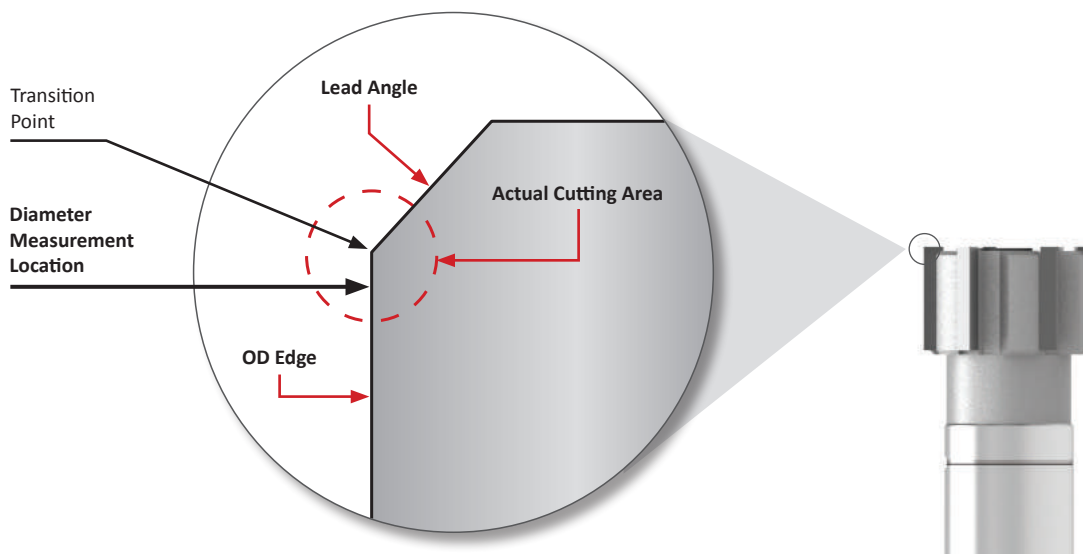

TIR Measurement

What is TIR?

Total indicator runout (TIR) refers to the distance to which the reamer is cutting off-center. In an ideal situation, the tool would begin in the exact center of the hole, and it would then rotate and cut in a perfect circle. This would result in a TIR of 0.

Because a perfect TIR of 0 is not practical, the goal is to maintain a TIR as close to 0 as possible. The closer the TIR is to 0, the better the reamer will perform.

Allied Machine recommends a TIR of $< 0.0005''$ (0.013 mm).

Think of attempting to draw a perfect circle with a drafting compass, but the pencil runs slightly outside the point where the circle began because the center point shifted during the pencil's path. This slight area of overlap would be the TIR.

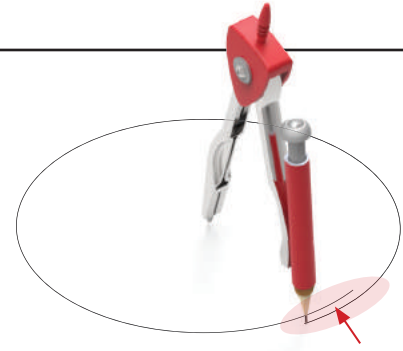

TIR: How far from center the tool will move during its path

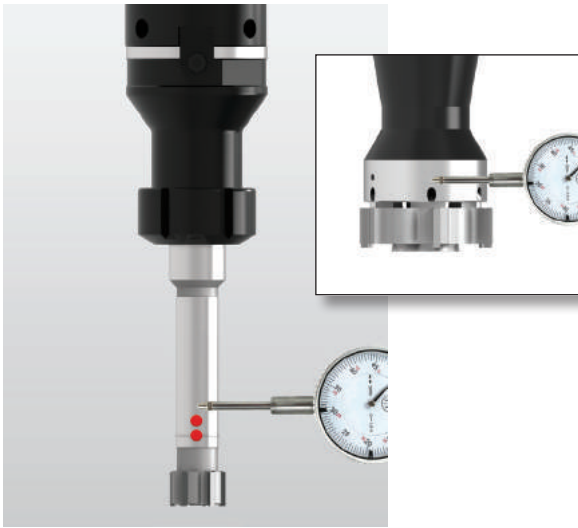

Step 1:

Check the TIR first on the mandrel (or ground) area of the reamer. Center the indicator in line with the dimple.

Measure the TIR by rotating the tool until the indicator reaches the highest value.

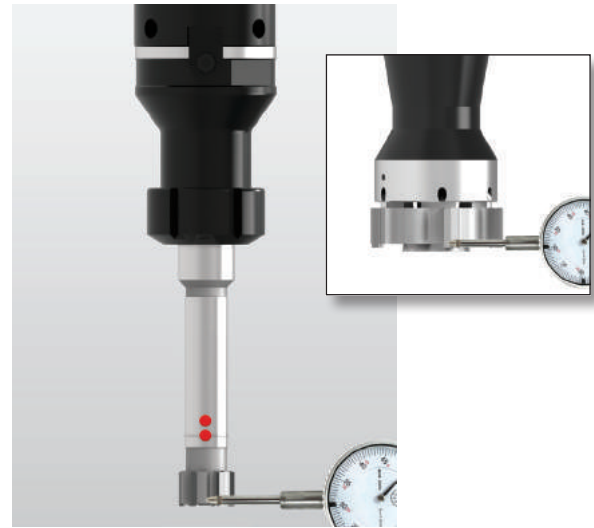

Step 2:

Next, check the TIR on the cutting teeth of the reamer.

NOTE: Rotate the tool counterclockwise to avoid chipping the cutting teeth with the indicator.

TIR Adjustment

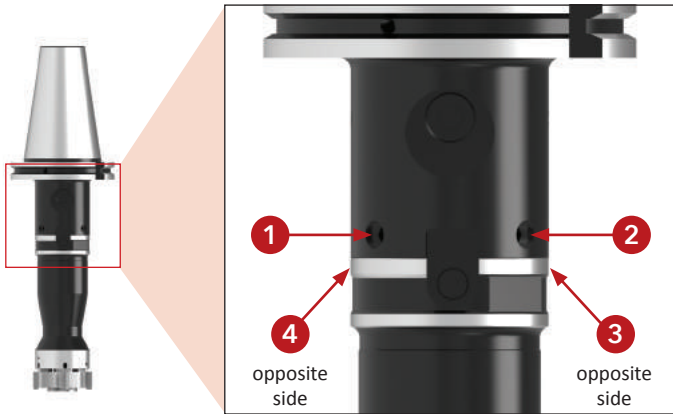

Step 1:

Place the tool into the machine spindle. Make contact with the four radial adjustment screws in a concentric fashion (this results in equal pressure surrounding the tool).

Tighten #1, then #3, followed by #2 and #4.



Step 2:

Swipe the dial indicator around the ground portion of the arbor near the coolant outlet holes to verify the TIR.

The TIR should be within 0.0005" (as close to 0 as possible). This will ensure the TIR check on the cutting teeth will be more true. It also means the arbor is running true to the shank.

Step 3:

Once the TIR is checked on the arbor, check the TIR on the cutting teeth. Rotate the tool counterclockwise to avoid chipping the cutting teeth.

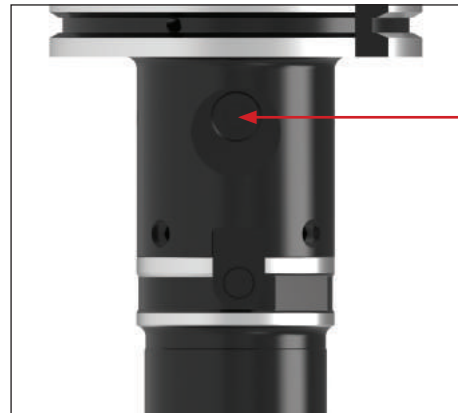
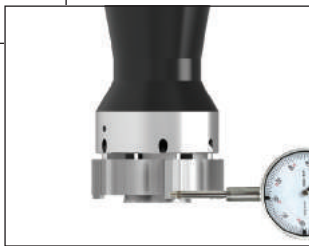

Clamping Screw

Step 4:

Tighten down the central clamping screws. During the tightening, the tool body will shift slightly. Repeat the TIR check on the cutting teeth and adjust as necessary.

Troubleshooting Guide

A

DRILLING

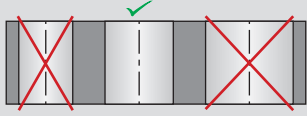

Oversized Hole

- Reamer is running eccentric to the center of the machine spindle ▶ Use modular system with radial adjustment
- Excessive misalignment causing reamer to cut on back taper ▶ Fix the misalignment
- Material buildup on cutting edges ▶ Replace the coolant or change the cutting speed
- Reamer diameter is too large ▶ Use smaller reamer or regrind existing reamer

B

BORING

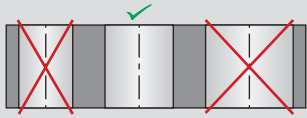

Undersized Hole

- The reamer diameter is too small ▶ Use larger reamer
- The reamer diameter is worn ▶ Expand, regrind, or replace the reamer
- The coolant is not suitable ▶ Replace the coolant
- Stock allowance is too small ▶ Increase the stock allowance
- The cutting speed is too low ▶ Increase the cutting speed

C

REAMING

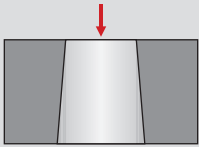

Tapered Hole

- Excessive misalignment ▶ Correct the misalignment

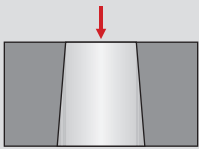

Burr at Hole Entry

- Excessive misalignment ▶ Correct the misalignment

D

BURNISHING

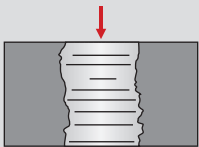

Hole is Not Straight

- Concentricity and alignment error between the workpiece and the tool ▶ Correct the misalignment and use the modular system with radial adjustment
- Asymmetrical cutting or angled surfaces ▶ Create a chamfer on the lead-in

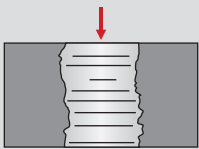

Poor Hole Finish

- One cutting edge is chipped ▶ Regrind the reamer
- The lead-in is irregular ▶ Regrind the reamer
- Back taper on the cutting edge is too great ▶ Regrind the reamer
- Excessive misalignment ▶ Correct the misalignment or use the modular system
- Cutting data is not correct ▶ Verify the cutting data
- Poor chip evacuation ▶ Verify the coolant volume and pressure or use through-tool coolant

E

THREADING

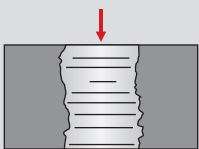

Reamer Creates Excessive Torque Loading

- Back taper on the cutting edge is too small ▶ Regrind the reamer
- The radially ground land is too wide ▶ Regrind the reamer
- The coolant is not suitable ▶ Replace the coolant

X

SPECIALS

Guaranteed Test / Demo Application Form

Distributor PO # _____

The following must be filled out completely before your test will be considered

Distributor Information

Company Name: _____
 Contact: _____
 Account Number: _____
 Phone: _____
 Email: _____

End User Information

Company Name: _____
 Contact: _____
 Industry: _____
 Phone: _____
 Email: _____

Current Process List all tooling, coatings, substrates, speeds and feeds, tool life, and any problems you are experiencing

Test Objective List what would make this a successful test (i.e. penetration rate, finish, tool life, hole size, etc.)

Application Information

Hole Diameter: _____ in/mm	Tolerance: _____	Material: _____ (4150 / A36 / Cast Iron / etc.)
Preexisting Diameter: _____ in/mm	Depth of Cut: _____ in/mm	Hardness: _____ (BHN / Rc)
Required Finish: _____ RMS	State: _____ (Casting / Hot rolled / Forging)	

Machine Information

Machine Type: _____ (Lathe / Screw machine / Machine center / etc.)	Builder: _____ (Haas, Mori Seiki, etc.)	Model #: _____
Shank Required: _____ (CAT50 / Morse taper, etc.)		Power: _____ HP/KW
Rigidity: _____	Orientation: _____	Tool Rotating: _____
<input type="checkbox"/> Excellent	<input type="checkbox"/> Vertical	<input type="checkbox"/> Yes
<input type="checkbox"/> Good	<input type="checkbox"/> Horizontal	<input type="checkbox"/> No
<input type="checkbox"/> Poor		Thrust: _____ lbs/N

Coolant Information

Coolant Delivery: _____ (Through tool / Flood)	Coolant Pressure: _____ PSI / bar
Coolant Type: _____ (Air mist, oil, synthetic, water soluble, etc.)	Coolant Volume: _____ GPM / LPM

Requested Tooling

QTY	Item Number	QTY	Item Number



ALLIED MACHINE & ENGINEERING

Allied Machine & Engineering
 120 Deeds Drive
 Dover, OH 44622

Telephone: (330) 343-4283
 Toll Free USA & Canada: (800) 321-5537
 Fax: (330) 602-3400

Warranty Information



Allied Machine & Engineering ("Allied Machine") warrants to original equipment manufacturers, distributors, industrial and commercial users of its products for one year from the original date of sale that each new product manufactured or supplied by Allied Machine shall be free from defects in material and workmanship.

Allied Machine's sole and exclusive obligation under this warranty is limited to, at its option, without additional charge, replacing or repairing this product or issuing a credit. For this warranty to be applied, the product must be returned freight prepaid to the plant designated by an Allied Machine representative and which, upon inspection, is determined by Allied Machine to be defective in material and workmanship.

Complete information as to operating conditions, machine, setup, and the application of cutting fluid should accompany any product returned for inspection. This warranty shall not apply to any Allied Machine products which have been subjected to misuse, abuse, improper operating conditions, improper machine setup or improper application of cutting fluid or which have been repaired or altered if such repair or alteration, in the judgement of Allied Machine, would adversely affect the performance of the product.

THIS WARRANTY IS IN LIEU OF ALL OTHER WARRANTIES, EXPRESS OR IMPLIED, INCLUDING ANY IMPLIED WARRANTY OF MERCHANTABILITY OR FITNESS FOR A PARTICULAR PURPOSE. Allied Machine shall have no liability or responsibility for any claim, whether in contract, tort or otherwise, for any loss or damage arising out of, connected with, or resulting from the manufacture, sale, delivery or use of any product sold hereunder, in excess of the cost of replacement or repair as provided herein.

Allied Machine shall not be liable in contract or in tort (including, without limitation, negligence, strict liability or otherwise) for economic losses of any kind or for any special, incidental, indirect, consequential, punitive or exemplary damages arising in any way out of the performance of, or failure to perform this agreement.

ALL PRICES, DELIVERIES, DESIGNS, AND MATERIALS ARE SUBJECT TO CHANGE WITHOUT NOTICE.



Allied Machine & Engineering
is registered to
ISO 9001:2015 by DQS

United States

Allied Machine & Engineering
120 Deeds Drive
Dover OH 44622
United States

Phone:
+1.330.343.4283
Fax:
+1.330.602.3400

Toll Free USA and Canada:
800.321.5537
Toll Free USA and Canada:
800.223.5140

Allied Machine & Engineering
485 W Third Street
Dover OH 44622
United States

Phone:
+1.330.343.4283
Fax:
+1.330.364.7666
(Engineering Dept.)

Toll Free USA and Canada:
800.321.5537

Europe

Allied Machine & Engineering Co. (Europe) Ltd.
93 Vantage Point
Pensnett Estate
Kingswinford
West Midlands
DY6 7FR England

Phone:
+44 (0) 1384.400900

Wohlhaupter GmbH
Maybachstrasse 4
Postfach 1264
72636 Frickenhausen
Germany

Phone:
+49 (0) 7022.408.0
Fax:
+49 (0) 7022.408.212

Asia

Wohlhaupter India Pvt. Ltd.
B-23, 3rd Floor
B Block Community Centre
Janakpuri, New Delhi - 110058
India

Phone:
+91 (0) 11.41827044

Your local Allied Machine representative:

www.alliedmachine.com

Allied Machine & Engineering is registered to ISO 9001:2015 by DQS

