



ALLIED MACHINE & ENGINEERING

Holemaking Solutions for Today's Manufacturing



Boring



Reaming



Burnishing



Threading



Specials



T-A Pro[®]

► **DRILLING**

High Penetration Replaceable Insert Drilling System

SECTION

A25

T-A Pro®

T-A Pro®

High Penetration Replaceable Insert Drilling System

► Diameter Range: 0.4369" - 1.8820" (11.10 mm - 47.80 mm)



The best just got better.

After 35 years of spade drilling success with our iconic T-A® (Throw Away) insert, the best just got better. Our team of engineers developed technology that takes THE "go-to" solution for general purpose holemaking to a performance level previously unachievable by a spade insert.

The T-A Pro combines material-specific insert geometries, a redesigned drill body, and a proprietary coolant-through system to allow penetration rates, which run at speeds faster than other high performance drills.

Excellent chip control	Improves hole quality and surface finish	Provides maximum durability and stability
------------------------	--	---

Applicable Industries

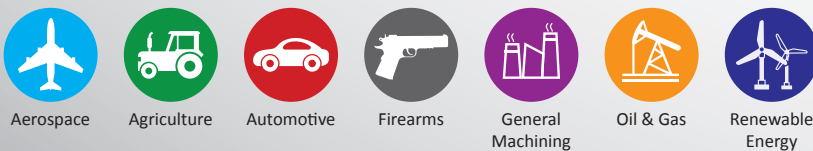

Your safety and the safety of others is very important. This catalog contains important safety messages. Always read and follow all safety precautions.



This triangle is a safety hazard symbol. It alerts you to potential safety hazards that can cause tool failure and serious injury.

When you see this symbol in the catalog, look for a related safety message that may be near this triangle or referred to in the nearby text.

There are safety signal words also used in the catalog. Safety messages follow these words.

WARNING

WARNING (shown above) means that failure to follow the precautions in this message could result in tool failure and serious injury.

NOTICE means that failure to follow the precautions in this message could result in damage to the tool or machine but not result in personal injury.

NOTE and **IMPORTANT** are also used. These are important that you read and follow but are not safety-related.

Visit www.alliedmachine.com for the most up-to-date information and procedures.

T-A Pro Drilling System Contents

Reference Icons

The following icons will appear throughout the catalog to help you navigate between products.

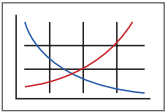

Recommended Cutting Data

Speed and feed recommendations for optimum and safe boring

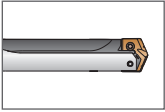

T-A Pro Holders

Refers to the range of holders that connect with the corresponding inserts

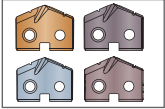

T-A Pro Carbide Inserts

Refers to ISO-material special coated carbide inserts that connect with the corresponding holders

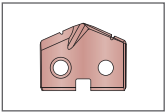

T-A Pro High-Speed Steel Inserts

Refers to HSS inserts that connect with the corresponding holders



Coolant-Through Option

Indicates that the product is coolant through

Series	Diameter Range	
	Imperial (inch)	Metric (mm)
Z	0.4369" - 0.4998"	11.10 mm - 12.69 mm
0	0.4999" - 0.6946"	12.70 mm - 17.64 mm
1	0.6947" - 0.9596"	17.65 mm - 24.37 mm
2	0.9597" - 1.3797"	24.38 mm - 35.04 mm
3	1.3798" - 1.8820"	35.05 mm - 47.80 mm

Introduction Information

Competitive Test Results	3
Case Studies	4 - 5
Insert Comparison and Assembly Information	6
T-A Pro Drilling System Information	7
Product Nomenclature	8 - 9

Z Series

Carbide Inserts	10
High-Speed Steel Inserts	11
Drill Holders	12 - 13

0 Series

Carbide Inserts	14 - 15
High-Speed Steel Inserts	16 - 17
Drill Holders	18 - 21

1 Series

Carbide Inserts	22 - 25
High-Speed Steel Inserts	26 - 29
Drill Holders	30 - 33

2 Series

Carbide Inserts	34 - 37
High-Speed Steel Inserts	38 - 41
Drill Holders	42 - 45

3 Series

Carbide Inserts	46 - 49
High-Speed Steel Inserts	50 - 53
Drill Holders	54 - 57

Recommended Cutting Data

Imperial (inch)	Carbide	58 - 59
	High-Speed Steel	60 - 61
Metric (mm)	Carbide	62 - 63
	High-Speed Steel	64 - 65

Tap Drill Information and Formulas

Imperial (inch)	66
Metric (mm)	67

Deep Hole Drilling Guidelines	68
-------------------------------	----

Troubleshooting Guide	69
-----------------------	----

T-A Pro®

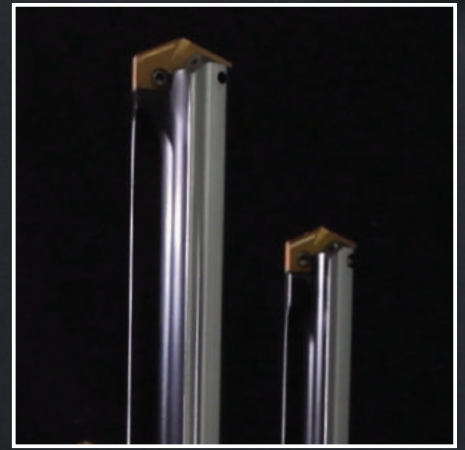
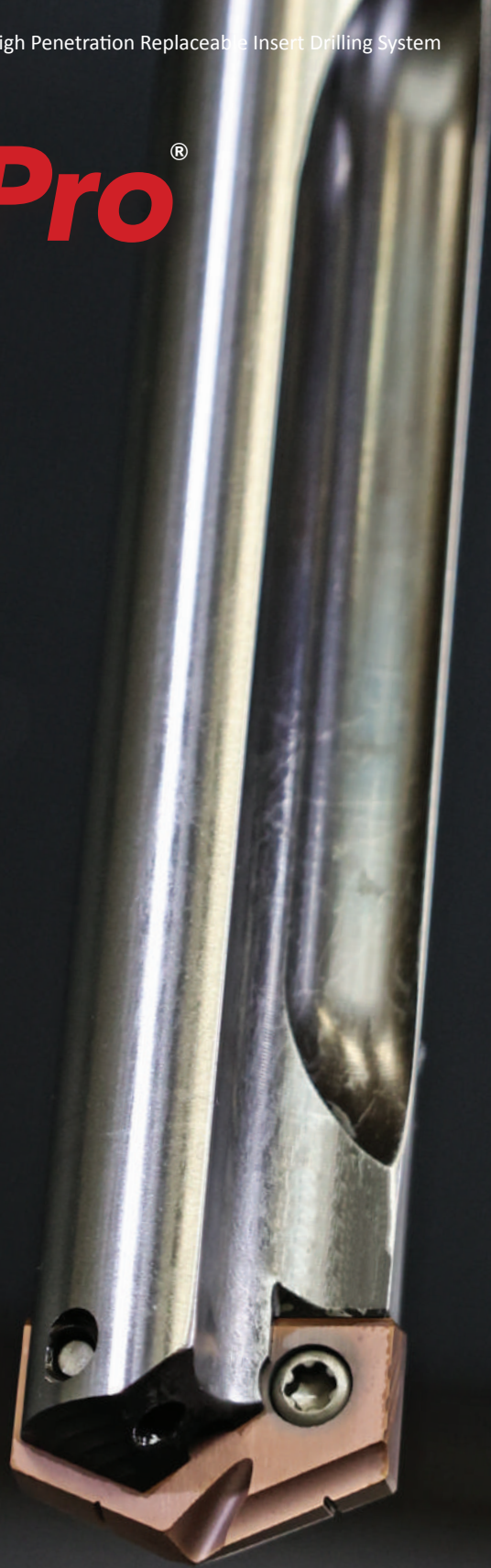

NEW HOLDER DESIGN

Optimized flute design for **increased chip evacuation**



NEW INSERT DESIGN

ISO-specific geometries with a new point design to **simplify** your insert choices



NEW COOLANT DESIGN

Proprietary coolant outlet configuration provides **superior** performance **even in low coolant applications (200 PSI)**

Competitive Test Results

T-A Pro® TEST RESULTS



Project Profile: Competitive Testing in 4340 Steel
Tooling Solution: T-A Pro: Steel (P) Geometry with T-A Pro Holder

- The Parameters:**
- Hole Diameter = 0.5625" (14.30 mm)
 - Depth of Cut = 2" (50.80 mm)
 - Coolant = 300 PSI
 - Speed = 2546 RPM
 - Feed = 16.55 inch/min (420 mm/min)

The Results:
 When run at the listed parameters, here is how the 3 different tooling solutions performed:

Competitor 1 = 3148 total linear inches
Competitor 2 = 3688 total linear inches
T-A Pro = 4316 total linear inches

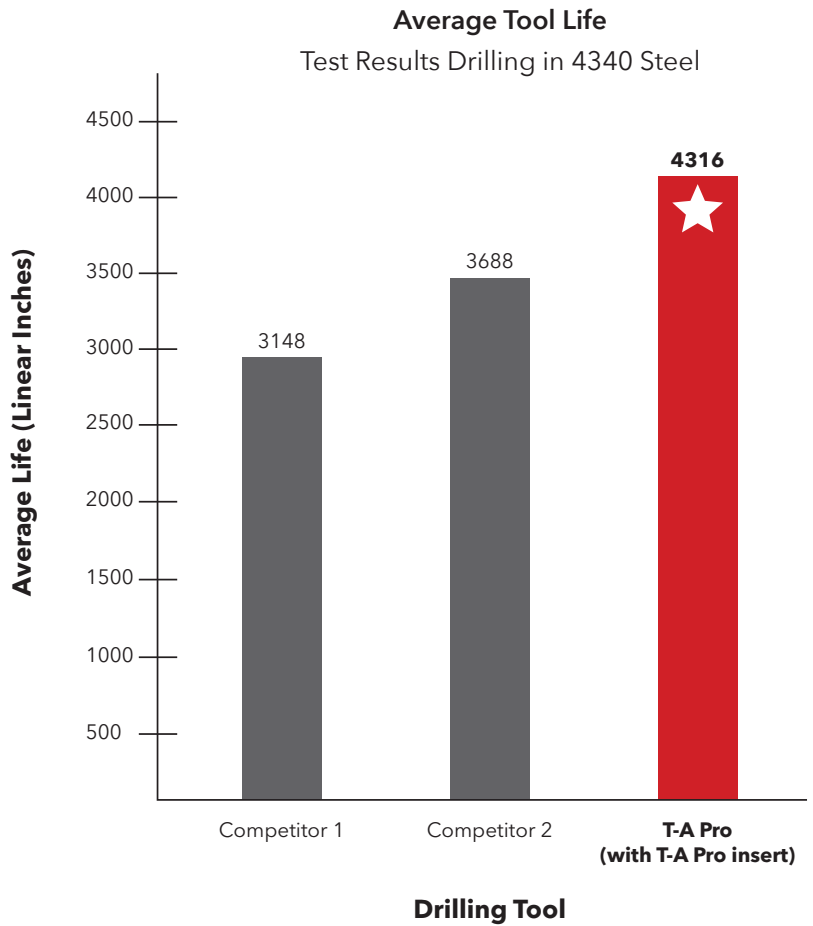

Case Study

The Gift that Keeps Giving.

Not everything in life has to be a give and take. Our customer who machines fluid end frac blocks was previously having to reduce cutting parameters to achieve good chip formation and produce a successful part.

Needing better chip formation with a reduced cycle time, the customer tested Allied's **T-A Pro drill**. Using the "M" ISO-specific stainless steel insert geometry—developed for improved chip formation while minimizing exit burr—they were able to increase their speed and feed while maintaining ideal chip formation.

On top of the reduced cycle time, the T-A Pro had a increase tool life lowering the cost per hole by 58.82%. The success of the T-A Pro in this application is just another example of why the T-A Pro is more than just a good drill.

If you are looking for a solution that just keeps giving, **give us a call, and we will help you find the right solution.**



Product:	T-A Pro drill	Measure	Competitor Drill	T-A Pro Drill
Objective:	Reduce cycle time	RPM	480	545
Industry:	Oil & gas/ Petrochemical	Speed Rate	220 SFM (67.06 M/min)	250 SFM (76.20 M/min)
Part:	Fluid end frac block	Feed Rate	0.005 IPR (0.13 mm/rev)	0.008 IPR (0.20 mm/rev)
Material:	15-5 PH Stainless Steel	Penetration Rate	2.4 IPM (60.96 mm/min)	4.4 IPM (111.76 mm/min)
Hole Ø:	1.75" (44.45 mm)	Total Part Cycle Time	500 sec	272 sec
Hole Depth:	20.00" (508.00 mm)	Tool Life	30 holes	60 holes
Tolerance:	+/- 0.005" (0.127 mm)	T-A Pro offered 58.82% cost per hole savings over the competitor tooling.		
Required Surface Finish:	125 Ra µin (3.2 µm)			

▶ T-A Pro holder
Item No. HTA3D15-150F

▶ T-A Pro insert
M geometry (stainless steel)
Item No. TAM3-44.45

*45.60%
cycle time decrease*

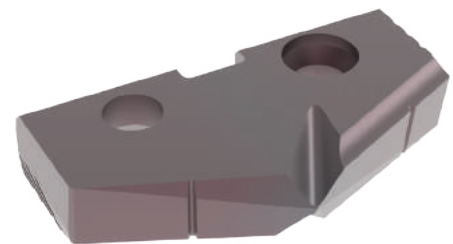

The ISO-specific AM460 coated T-A Pro insert provided:

- ✓ Increased tool life
- ✓ Decreased cycle time
- ✓ Decreased cost per hole
- ✓ Increased penetration rate

Case Study

Need a solution with better tool life?

Our customer was machining engine block parts from ductile cast iron in a production cell. The replaceable tip drill they were using wasn't providing the results they needed, so they began searching for a tooling solution that would decrease machine downtime and increase productivity.

The customer tested the **T-A Pro® high penetration replaceable insert drill** using the "K" (cast iron) geometry insert with Allied's multilayer TiAlN coating that provides increased abrasion resistance and tool life. The T-A Pro performed better than the customer had hoped.

Using the T-A Pro not only provided substantial tool life improvements, but it also improved the penetration rate. The previous tooling had a tool life of 1700 holes, but the T-A Pro increased that life to 3400 holes. The T-A Pro also increased penetration rates by 30%. This allowed the customer to increase their productivity.

The bottom line: Our customer was able to save \$60k in tool savings per year with massive improvements in throughput. The advantage of the T-A Pro allowed our customer to achieve their tooling goals.

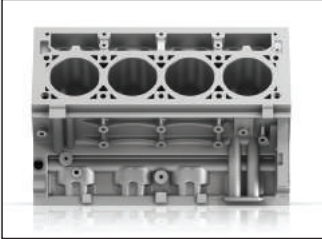

	Measure	Competitor Replaceable Insert Drill	T-A Pro Drill
Product: T-A Pro	RPM	1819 RPM	2092 RPM
Objectives: (1) Decrease machine downtime (2) Increase productivity	Speed	300 SFM (91 M/min)	345 SFM (105 M/min)
Industry: Automotive	Feed Rate	0.008 IPR (0.20 mm/rev)	0.0092 IPR (0.23 mm/rev)
Part: Engine block	Penetration Rate	14.55 IPM (369.57 mm/min)	19.25 IPM (488.95 mm/min)
Material: Ductile Cast Iron	Cycle Time	39 seconds	29 seconds
Hole Ø: 0.6299" (16.00 mm)	Tool Life	1700 holes	3400 holes
Hole Depth: 9.50" (241.00 mm)			

- ▶ T-A Pro Drill holder
15xD length
Item No. HTA0C15-075C
- ▶ T-A Pro Drill inserts
K geometry
(cast iron)
Item No. TAK0-16.00





increased tool life by 100%

The cast iron TiAlN coated T-A Pro insert provided:

- ✓ Doubled tool life
- ✓ Decreased machine downtime
- ✓ Increased productivity
- ✓ 30% increased penetration rate
- ✓ Increased tool savings per year

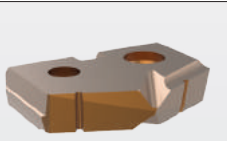
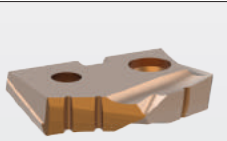
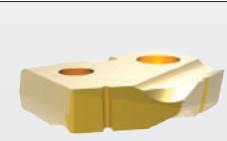

Insert Comparison and Assembly Information

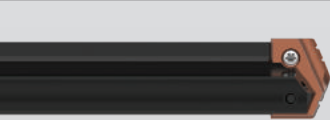
				
		T-A Pro® Inserts	GEN2 T-A® Inserts	T-A® Inserts
B	Recommended for increased productivity 	<input checked="" type="checkbox"/>		
BORING	ISO-specific geometry/coating combination 	<input checked="" type="checkbox"/>		
C	Connects with T-A Pro holders 	<input checked="" type="checkbox"/>	<input checked="" type="checkbox"/>	<input checked="" type="checkbox"/>
REAMING	Connects with T-A holders 	<input checked="" type="checkbox"/>	<input checked="" type="checkbox"/>	<input checked="" type="checkbox"/>

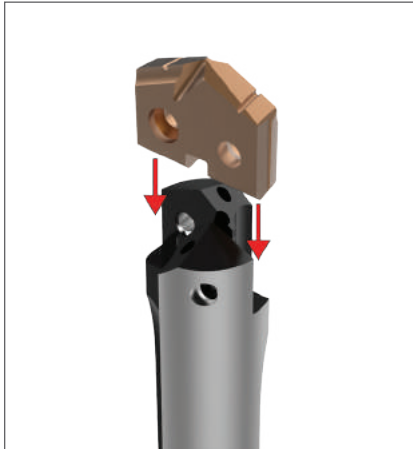

Step 1:
Align the flats on the T-A Pro insert with the flats on the ears of the holder.

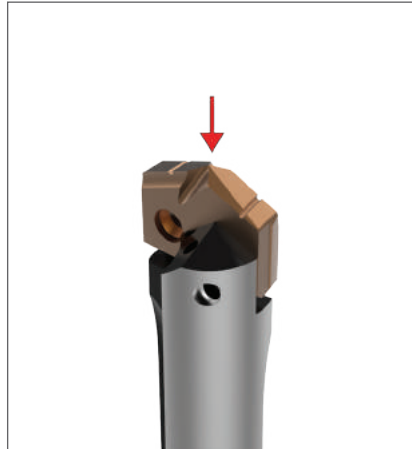

Step 2:
Slide the insert into the precision ground locating pocket on the holder. The insert should not be turned, rotated, or twisted for locking purposes. The holder pocket and locating pads on the insert assure optimum fit and repeatability.

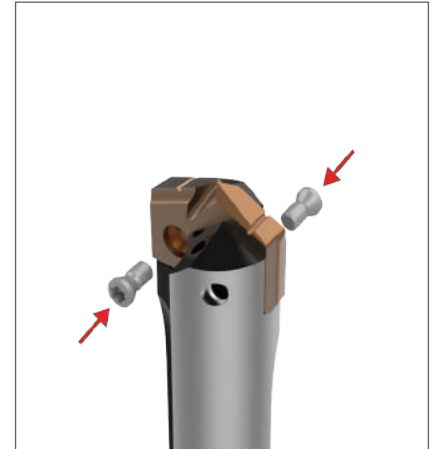

Step 3:
Apply a generous amount of E-Z Break® (provided in the packaging) onto the supplied TORX® Plus screws.

Tighten the TORX Plus screws to the recommended torque value specified in the catalog by series. A preset torx driver is available to assure that the proper torque is applied.

T-A Pro Drilling System Information

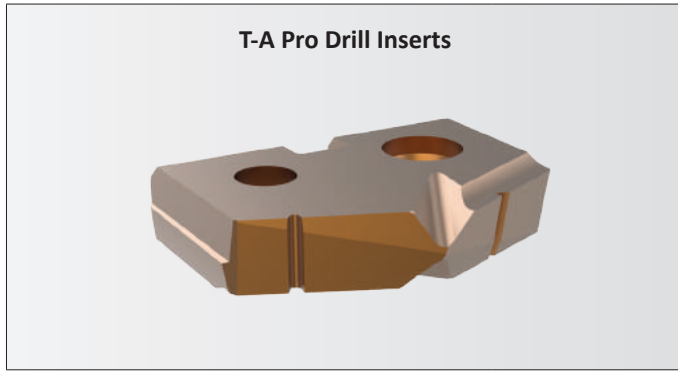

Carbide Geometries

P - Steels

- Designed to provide increased penetration rates and tool life in steel applications
- Superior geometry and edge provides excellent chip control
- Allied's multilayer AM300® coating increases heat resistance and improves tool life

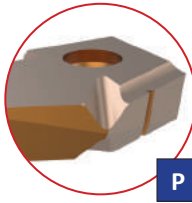

P

K - Cast Irons

- Uniquely designed for cast/ductile iron applications
- Geometry developed for maximum tool life, reduced exit burr, and improved hole finish
- Allied's multilayer TiAlN coating provides increased abrasion resistance and tool life

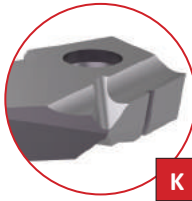

K

N - Nonferrous Materials

- Designed for applications in aluminum, brass, and copper
- The geometry yields excellent chip control in these softer materials
- TiCN coating gives the versatility to run in a variety of materials while reducing buildup

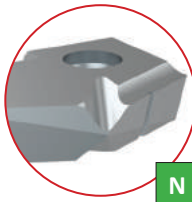

N

M - Stainless Steel

- Designed for all stainless steels and heat-resistant super alloys
- Geometry optimized for improved chip formation while minimizing exit burr
- Allied's new AM460 coating provides industry leading tool life in stainless and HRSA materials

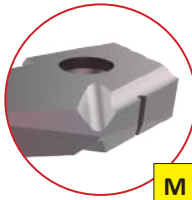

M

Advanced Design Capabilities

The advanced T-A Pro insert combines a coating and geometry specifically designed to achieve optimal results in ISO material drilling applications. With quick connectivity to existing T-A drill insert holders, the T-A Pro insert can be interchanged with previous T-A inserts with ease, resulting in minimal setup times so you can immediately increase your productivity.

T-A Pro Inserts Connect with:



T-A Pro holders



T-A holders

High Speed Steel Geometries

X - High-Speed Steel Materials

- Improved chip geometry for excellent chip control in all materials
- Long tool life and high-process security for the most challenging applications
- Allied's multilayer AM200® coating combines excellent heat resistance and high lubricity for wide application use

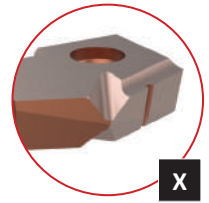

X

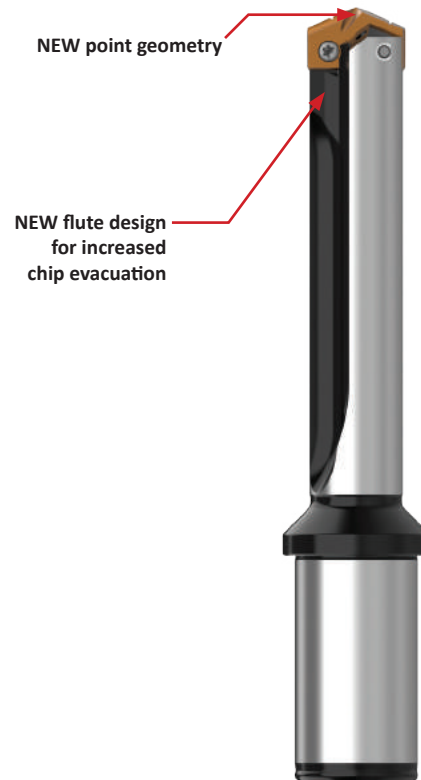

T-A Pro Drill Holders



Straight flutes



Proprietary coolant outlets improve coolant flow



Provides increased insert life

STUB, 3xD, 5xD, 7xD,
10xD, 12xD, 15xD

Available in STUB, 3xD, 5xD, 7xD,
10xD, 12xD, and 15xD

Product Nomenclature

T-A Pro Drill Inserts

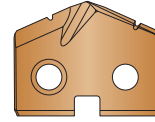

TA	P	0	-	15.00
1	2	3		4

1. T-A Pro Drill Insert	2. ISO Material / Geometry	3. Series	4. Diameter (mm)
TA = T-A Pro insert	P = Steel K = Cast iron N = Nonferrous M = Stainless Steel X = HSS	Z = Z series 0 = 0 series 1 = 1 series 2 = 2 series 3 = 3 series	For complete list of diameter ranges by series, see contents page.

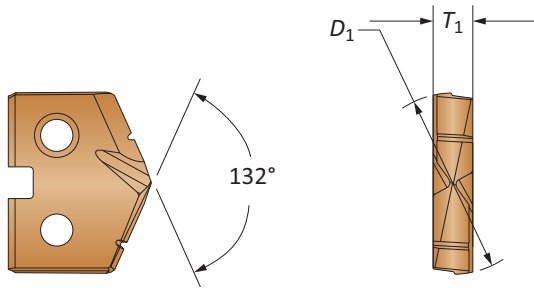

Reference Key

Symbol	Attribute
D_1	Insert diameter
T_1	Insert thickness

Product Nomenclature

T-A Pro Drill Holders

HTA	1	A	05	-	100	C
1	2	3	4		5	6

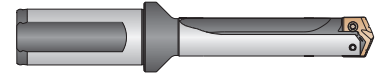

<p>1. Holder</p> <p>HTA = T-A Pro holder</p>	<p>2. Series</p> <p>Z = Z Series 0 = 0 Series 1 = 1 Series 2 = 2 Series 3 = 3 Series</p>	<p>3. Body Diameter</p> <p>A = A body diameter B = B body diameter C = C body diameter D = D body diameter</p>	<p>4. Length</p> <p>01 = Stub Length 03 = 3x Diameter 05 = 5x Diameter 07 = 7x Diameter 10 = 10x Diameter 12 = 12x Diameter 15 = 15x Diameter</p>								
<p>5. Shank Diameter</p> <table border="1"> <thead> <tr> <th>Imperial (inch)</th> <th>Metric (mm)</th> </tr> </thead> <tbody> <tr> <td>075 = 3/4"</td> <td>20 = 20 mm</td> </tr> <tr> <td>100 = 1"</td> <td>25 = 25 mm</td> </tr> <tr> <td>125 = 1-1/4"</td> <td>32 = 32 mm</td> </tr> <tr> <td>150 = 1-1/2"</td> <td>40 = 40 mm</td> </tr> </tbody> </table>	Imperial (inch)	Metric (mm)	075 = 3/4"	20 = 20 mm	100 = 1"	25 = 25 mm	125 = 1-1/4"	32 = 32 mm	150 = 1-1/2"	40 = 40 mm	<p>6. Shank Style</p> <p>F = Flanged with flat FM = Flanged metric with flat C = Cylindrical (no flat) CM = Cylindrical metric (no flat)</p>
Imperial (inch)	Metric (mm)										
075 = 3/4"	20 = 20 mm										
100 = 1"	25 = 25 mm										
125 = 1-1/4"	32 = 32 mm										
150 = 1-1/2"	40 = 40 mm										

Holder Ordering Information

The series designator (Z series, 0 series, etc.) in the top corner of each page is for your reference when ordering. Please refer to these series designators when placing an order. For example, a Z series drill insert only fits into a Z series holder.

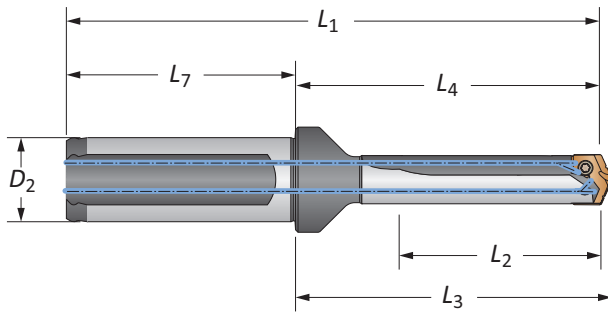





Reference Key

Symbol	Attribute
D_2	Shank diameter
L_1	Overall length
L_2	Drill depth
L_3	Holder reference length
L_4	Holder body length
L_7	Shank length

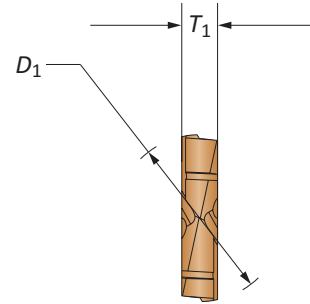
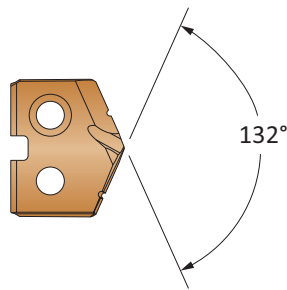
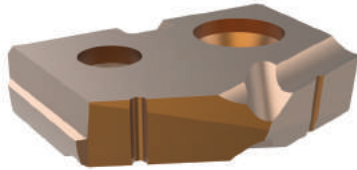
T-A Pro Carbide Drill Inserts

Z Series | Diameter Range: 0.4369" - 0.4998" (11.10 mm - 12.69 mm)



Insert								
Series	Fractional Equivalent	D_1 inch	D_1 mm	T_1	Part No. P	Part No. K	Part No. N	Part No. M
Z-A	7/16	0.4374	11.11	3/32	TAPZ-11.11	TAKZ-11.11	TANZ-11.11	TAMZ-11.11
Z-A		0.4409	11.20	3/32	TAPZ-11.20	TAKZ-11.20	TANZ-11.20	TAMZ-11.20
Z-A		0.4449	11.30	3/32	TAPZ-11.30	TAKZ-11.30	TANZ-11.30	TAMZ-11.30
Z-A		0.4488	11.40	3/32	TAPZ-11.40	TAKZ-11.40	TANZ-11.40	TAMZ-11.40
Z-A		0.4528	11.50	3/32	TAPZ-11.50	TAKZ-11.50	TANZ-11.50	TAMZ-11.50
Z-A	29/64	0.4531	11.51	3/32	TAPZ-11.51	TAKZ-11.51	TANZ-11.51	TAMZ-11.51
Z-A		0.4567	11.60	3/32	TAPZ-11.60	TAKZ-11.60	TANZ-11.60	TAMZ-11.60
Z-A		0.4606	11.70	3/32	TAPZ-11.70	TAKZ-11.70	TANZ-11.70	TAMZ-11.70
Z-A		0.4646	11.80	3/32	TAPZ-11.80	TAKZ-11.80	TANZ-11.80	TAMZ-11.80
Z-A	15/32	0.4689	11.91	3/32	TAPZ-11.91	TAKZ-11.91	TANZ-11.91	TAMZ-11.91
Z-A		0.4724	12.00	3/32	TAPZ-12.00	TAKZ-12.00	TANZ-12.00	TAMZ-12.00
Z-A		0.4764	12.10	3/32	TAPZ-12.10	TAKZ-12.10	TANZ-12.10	TAMZ-12.10
Z-B		0.4803	12.20	3/32	TAPZ-12.20	TAKZ-12.20	TANZ-12.20	TAMZ-12.20
Z-B	31/64	0.4843	12.30	3/32	TAPZ-12.30	TAKZ-12.30	TANZ-12.30	TAMZ-12.30
Z-B		0.4882	12.40	3/32	TAPZ-12.40	TAKZ-12.40	TANZ-12.40	TAMZ-12.40
Z-B		0.4921	12.50	3/32	TAPZ-12.50	TAKZ-12.50	TANZ-12.50	TAMZ-12.50
Z-B		0.4961	12.60	3/32	TAPZ-12.60	TAKZ-12.60	TANZ-12.60	TAMZ-12.60

Inserts sold in multiples of 2

Sub Series Holders (A, B, C, D)

Sub series holders are recommended when running carbide inserts toward the upper end of the series drill range, as well as in tougher applications requiring more insert support and holder strength. **NOTE:** Only specified sub series inserts should be used with equivalent or smaller sub series holders.



A Series Insert +
A Series Holder



C Series Insert +
A Series Holder



C Series Insert +
C Series Holder



A Series Insert +
C Series Holder

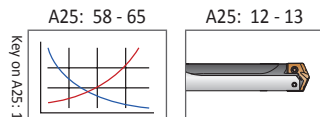

A25: 10

Sizes not shown are available upon request.
When ordering, please follow the example below:

Imperial:	0.5180", Steel, 0 series = use Part No. TAP0-13.16
Metric:	13.16 mm, Steel, 0 series = use Part No. TAP0-13.16

T-A Pro HSS Drill Inserts

Z Series | Diameter Range: 0.4369" - 0.4998" (11.10 mm - 12.69 mm)

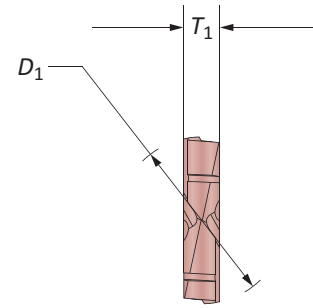
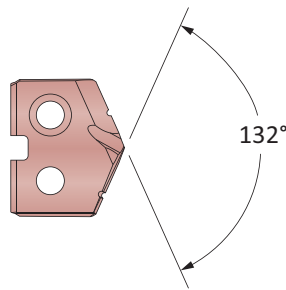
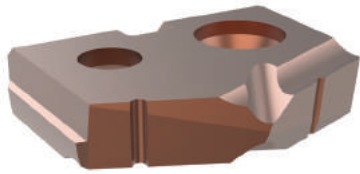

Series	Fractional Equivalent	Insert			Part No.	
		D ₁ inch	D ₁ mm	T ₁		
Z-A	7/16	0.4374	11.11	3/32	TAXZ-11.11	
Z-A		0.4409	11.20	3/32	TAXZ-11.20	
Z-A		0.4449	11.30	3/32	TAXZ-11.30	
Z-A		0.4488	11.40	3/32	TAXZ-11.40	
Z-A		0.4528	11.50	3/32	TAXZ-11.50	
Z-A	29/64	0.4531	11.51	3/32	TAXZ-11.51	
Z-A		0.4567	11.60	3/32	TAXZ-11.60	
Z-A		0.4606	11.70	3/32	TAXZ-11.70	
Z-A		0.4646	11.80	3/32	TAXZ-11.80	
Z-A	15/32	0.4689	11.91	3/32	TAXZ-11.91	
Z-A		0.4724	12.00	3/32	TAXZ-12.00	
Z-A		0.4764	12.10	3/32	TAXZ-12.10	
Z-B		31/64	0.4803	12.20	3/32	TAXZ-12.20
Z-B			0.4843	12.30	3/32	TAXZ-12.30
Z-B	0.4882		12.40	3/32	TAXZ-12.40	
Z-B	0.4921		12.50	3/32	TAXZ-12.50	
Z-B	0.4961		12.60	3/32	TAXZ-12.60	

Inserts sold in multiples of 2

Sub Series Holders (A, B, C, D)

Sub series holders are recommended when running carbide inserts toward the upper end of the series drill range, as well as in tougher applications requiring more insert support and holder strength. **NOTE:** Only specified sub series inserts should be used with equivalent or smaller sub series holders.



A Series Insert + A Series Holder



C Series Insert + A Series Holder



C Series Insert + C Series Holder



A Series Insert + C Series Holder

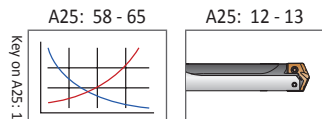

Sizes not shown are available upon request.	
When ordering, please follow the example below:	
Imperial:	0.5180", Steel, 0 series = use Part No. TAP0-13.16
Metric:	13.16 mm, Steel, 0 series = use Part No. TAP0-13.16

T-A Pro Drill Holders

Z Series Imperial | Diameter Range: 0.4369" - 0.4998"

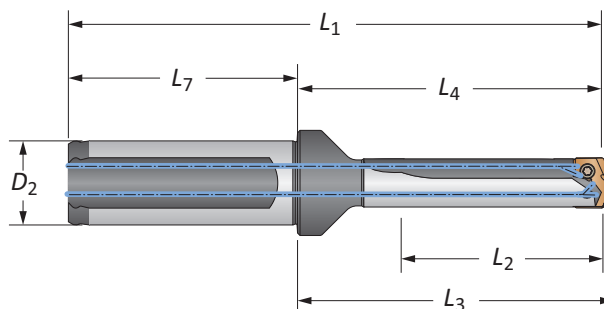

		Body				Shank				
Length	Sub Series	L ₂	L ₄	L ₃	L ₁	L ₇	D ₂	Flat	Part No	
STUB	A	0.504	1.600	1.710	3.630	2.030	3/4	Yes	HTAZA01-075F	
STUB	A	0.504	1.600	1.710	3.630	2.030	3/4	No	HTAZA01-075C	
STUB	B	0.504	1.600	1.710	3.630	2.030	3/4	Yes	HTAZB01-075F	
STUB	B	0.504	1.600	1.710	3.630	2.030	3/4	No	HTAZB01-075C	
3xD	A	1.452	2.693	2.803	4.723	2.030	3/4	Yes	HTAZA03-075F	
3xD	A	1.452	2.693	2.803	4.723	2.030	3/4	No	HTAZA03-075C	
3xD	B	1.452	2.693	2.803	4.723	2.030	3/4	Yes	HTAZB03-075F	
3xD	B	1.452	2.693	2.803	4.723	2.030	3/4	No	HTAZB03-075C	
5xD	A	2.400	3.641	3.751	5.671	2.030	3/4	Yes	HTAZA05-075F	
5xD	A	2.400	3.641	3.751	5.671	2.030	3/4	No	HTAZA05-075C	
5xD	B	2.400	3.641	3.751	5.671	2.030	3/4	Yes	HTAZB05-075F	
5xD	B	2.400	3.641	3.751	5.671	2.030	3/4	No	HTAZB05-075C	
7xD	A	3.348	4.589	4.699	6.619	2.030	3/4	Yes	HTAZA07-075F	
7xD	A	3.348	4.589	4.699	6.619	2.030	3/4	No	HTAZA07-075C	
7xD	B	3.348	4.589	4.699	6.619	2.030	3/4	Yes	HTAZB07-075F	
7xD	B	3.348	4.589	4.699	6.619	2.030	3/4	No	HTAZB07-075C	
10xD	A	4.770	6.011	6.121	8.041	2.030	3/4	Yes	HTAZA10-075F	
10xD	A	4.770	6.011	6.121	8.041	2.030	3/4	No	HTAZA10-075C	
10xD	B	4.770	6.011	6.121	8.041	2.030	3/4	Yes	HTAZB10-075F	
10xD	B	4.770	6.011	6.121	8.041	2.030	3/4	No	HTAZB10-075C	
12xD	A	5.718	6.959	7.069	8.989	2.030	3/4	Yes	HTAZA12-075F	
12xD	A	5.718	6.959	7.069	8.989	2.030	3/4	No	HTAZA12-075C	
12xD	B	5.718	6.959	7.069	8.989	2.030	3/4	Yes	HTAZB12-075F	
12xD	B	5.718	6.959	7.069	8.989	2.030	3/4	No	HTAZB12-075C	
15xD	A	7.140	8.381	8.491	10.411	2.030	3/4	Yes	HTAZA15-075F	
15xD	A	7.140	8.381	8.491	10.411	2.030	3/4	No	HTAZA15-075C	
15xD	B	7.140	8.381	8.491	10.411	2.030	3/4	Yes	HTAZB15-075F	
15xD	B	7.140	8.381	8.491	10.411	2.030	3/4	No	HTAZB15-075C	

Connection Accessories

					Admissible Tightening Torque*
7247-IP7-1	7247N-IP7-1	8IP-7	8IP-7TL	8IP-7B	7.4 in-lbs (84 N-cm)

*Tightening torques are calculated with a friction coefficient of $\mu = 0.14$ and develop 90% of ultimate yield strength

⚠ WARNING Refer to Speed and Feed charts for recommended adjustments to speeds and feeds. Refer to page A25: 68 for deep hole drilling guidelines in this section of the catalog. Visit www.alliedmachine.com/DeepHoleGuidelines for the most up-to-date information and procedures. Factory technical assistance is available for your specific applications through our Application Engineering department.
 ext: 7611 | email: appeng@alliedmachine.com

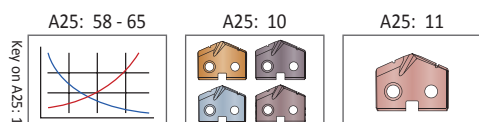

= Imperial (in)
 = Metric (mm)

Screws sold in multiples of 10



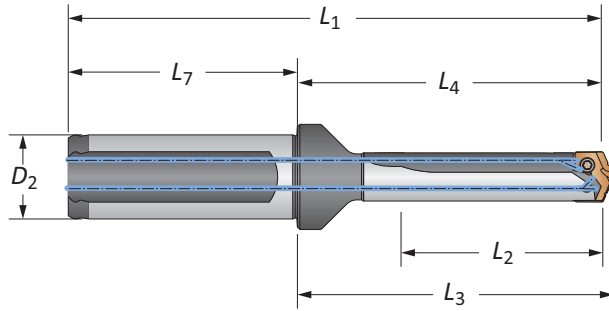

T-A Pro Drill Holders

Z Series Metric | Diameter Range: 11.11 mm - 12.69 mm



Length	Sub Series	Body				Shank				Part No
		L ₂	L ₄	L ₃	L ₁	L ₇	D ₂	Flat		
STUB	A	12.8	40.7	43.4	90.7	50.0	20	Yes	HTAZA01-20FM	
STUB	A	12.8	40.7	43.4	90.7	50.0	20	No	HTAZA01-20CM	
STUB	B	12.8	40.7	43.4	90.7	50.0	20	Yes	HTAZB01-20FM	
STUB	B	12.8	40.7	43.4	90.7	50.0	20	No	HTAZB01-20CM	
3xD	A	36.9	68.4	71.2	118.4	50.0	20	Yes	HTAZA03-20FM	
3xD	A	36.9	68.4	71.2	118.4	50.0	20	No	HTAZA03-20CM	
3xD	B	36.9	68.4	71.2	118.4	50.0	20	Yes	HTAZB03-20FM	
3xD	B	36.9	68.4	71.2	118.4	50.0	20	No	HTAZB03-20CM	
5xD	A	61.0	92.5	95.3	142.5	50.0	20	Yes	HTAZA05-20FM	
5xD	A	61.0	92.5	95.3	142.5	50.0	20	No	HTAZA05-20CM	
5xD	B	61.0	92.5	95.3	142.5	50.0	20	Yes	HTAZB05-20FM	
5xD	B	61.0	92.5	95.3	142.5	50.0	20	No	HTAZB05-20CM	
7xD	A	85.0	116.5	119.3	166.6	50.0	20	Yes	HTAZA07-20FM	
7xD	A	85.0	116.5	119.3	166.6	50.0	20	No	HTAZA07-20CM	
7xD	B	85.0	116.5	119.3	166.6	50.0	20	Yes	HTAZB07-20FM	
7xD	B	85.0	116.5	119.3	166.6	50.0	20	No	HTAZB07-20CM	
10xD	A	121.2	152.7	155.5	202.7	50.0	20	Yes	HTAZA10-20FM	
10xD	A	121.2	152.7	155.5	202.7	50.0	20	No	HTAZA10-20CM	
10xD	B	121.2	152.7	155.5	202.7	50.0	20	Yes	HTAZB10-20FM	
10xD	B	121.2	152.7	155.5	202.7	50.0	20	No	HTAZB10-20CM	
12xD	A	145.2	176.7	179.5	226.8	50.0	20	Yes	HTAZA12-20FM	
12xD	A	145.2	176.7	179.5	226.8	50.0	20	No	HTAZA12-20CM	
12xD	B	145.2	176.7	179.5	226.8	50.0	20	Yes	HTAZB12-20FM	
12xD	B	145.2	176.7	179.5	226.8	50.0	20	No	HTAZB12-20CM	
15xD	A	181.4	212.9	215.7	262.9	50.0	20	Yes	HTAZA15-20FM	
15xD	A	181.4	212.9	215.7	262.9	50.0	20	No	HTAZA15-20CM	
15xD	B	181.4	212.9	215.7	262.9	50.0	20	Yes	HTAZB15-20FM	
15xD	B	181.4	212.9	215.7	262.9	50.0	20	No	HTAZB15-20CM	

Connection Accessories

					Admissible Tightening Torque* 7.4 in-lbs (84 N-cm)
7247-IP7-1	7247N-IP7-1	8IP-7	8IP-7TL	8IP-7B	

*Tightening torques are calculated with a friction coefficient of $\mu = 0.14$ and develop 90% of ultimate yield strength

⚠ WARNING Refer to Speed and Feed charts for recommended adjustments to speeds and feeds. Refer to page A25: 68 for deep hole drilling guidelines in this section of the catalog. Visit www.alliedmachine.com/DeepHoleGuidelines for the most up-to-date information and procedures. Factory technical assistance is available for your specific applications through our Application Engineering department.
ext: 7611 | email: appeng@alliedmachine.com

Key on A25: 1

A25: 58 - 65

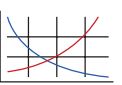

A25: 10

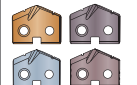

A25: 11

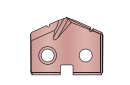





ⓘ = Imperial (in)
Ⓜ = Metric (mm)

Screws sold in multiples of 10

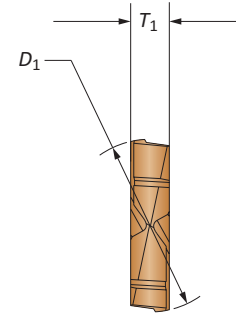
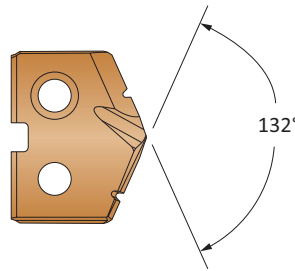
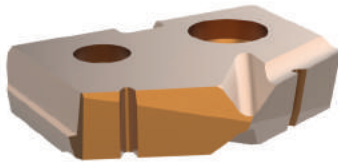
T-A Pro Carbide Drill Inserts

0 Series | Diameter Range: 0.4999" - 0.6946" (12.70 mm - 17.64 mm)



Insert								
Series	Fractional Equivalent	D ₁ inch	D ₁ mm	T ₁	Part No. P	Part No. K	Part No. N	Part No. M
0-A	1/2	0.5000	12.70	1/8	TAP0-12.70	TAK0-12.70	TAN0-12.70	TAM0-12.70
0-A		0.5039	12.80	1/8	TAP0-12.80	TAK0-12.80	TAN0-12.80	TAM0-12.80
0-A		0.5079	12.90	1/8	TAP0-12.90	TAK0-12.90	TAN0-12.90	TAM0-12.90
0-A		0.5118	13.00	1/8	TAP0-13.00	TAK0-13.00	TAN0-13.00	TAM0-13.00
0-A	33/64	0.5157	13.10	1/8	TAP0-13.10	TAK0-13.10	TAN0-13.10	TAM0-13.10
0-A		0.5197	13.20	1/8	TAP0-13.20	TAK0-13.20	TAN0-13.20	TAM0-13.20
0-A		0.5236	13.30	1/8	TAP0-13.30	TAK0-13.30	TAN0-13.30	TAM0-13.30
0-A		0.5276	13.40	1/8	TAP0-13.40	TAK0-13.40	TAN0-13.40	TAM0-13.40
0-A	17/32	0.5311	13.49	1/8	TAP0-13.49	TAK0-13.49	TAN0-13.49	TAM0-13.49
0-A		0.5315	13.50	1/8	TAP0-13.50	TAK0-13.50	TAN0-13.50	TAM0-13.50
0-A		0.5354	13.60	1/8	TAP0-13.60	TAK0-13.60	TAN0-13.60	TAM0-13.60
0-A		0.5394	13.70	1/8	TAP0-13.70	TAK0-13.70	TAN0-13.70	TAM0-13.70
0-A		0.5433	13.80	1/8	TAP0-13.80	TAK0-13.80	TAN0-13.80	TAM0-13.80
0-A	35/64	0.5469	13.89	1/8	TAP0-13.89	TAK0-13.89	TAN0-13.89	TAM0-13.89
0-B		0.5512	14.00	1/8	TAP0-14.00	TAK0-14.00	TAN0-14.00	TAM0-14.00
0-B		0.5551	14.10	1/8	TAP0-14.10	TAK0-14.10	TAN0-14.10	TAM0-14.10
0-B		0.5591	14.20	1/8	TAP0-14.20	TAK0-14.20	TAN0-14.20	TAM0-14.20
0-B	9/16	0.5626	14.29	1/8	TAP0-14.29	TAK0-14.29	TAN0-14.29	TAM0-14.29
0-B		0.5669	14.40	1/8	TAP0-14.40	TAK0-14.40	TAN0-14.40	TAM0-14.40
0-B		0.5709	14.50	1/8	TAP0-14.50	TAK0-14.50	TAN0-14.50	TAM0-14.50
0-B		0.5748	14.60	1/8	TAP0-14.60	TAK0-14.60	TAN0-14.60	TAM0-14.60
0-B	37/64	0.5780	14.68	1/8	TAP0-14.68	TAK0-14.68	TAN0-14.68	TAM0-14.68
0-B		0.5827	14.80	1/8	TAP0-14.80	TAK0-14.80	TAN0-14.80	TAM0-14.80
0-B		0.5866	14.90	1/8	TAP0-14.90	TAK0-14.90	TAN0-14.90	TAM0-14.90
0-B		0.5906	15.00	1/8	TAP0-15.00	TAK0-15.00	TAN0-15.00	TAM0-15.00

Inserts sold in multiples of 2

Sub Series Holders (A, B, C, D)

Sub series holders are recommended when running carbide inserts toward the upper end of the series drill range, as well as in tougher applications requiring more insert support and holder strength. **NOTE:** Only specified sub series inserts should be used with equivalent or smaller sub series holders.



A Series Insert +
A Series Holder



C Series Insert +
A Series Holder



C Series Insert +
C Series Holder



A Series Insert +
C Series Holder

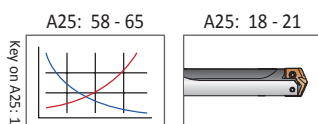



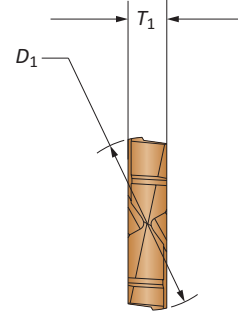
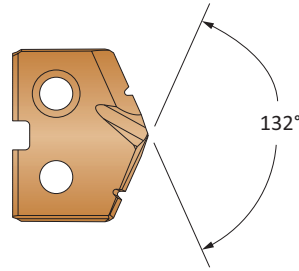
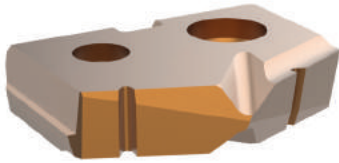

Sizes not shown are available upon request. When ordering, please follow the example below:	
Imperial:	0.5180", Steel, 0 series = use Part No. TAP0-13.16
Metric:	13.16 mm, Steel, 0 series = use Part No. TAP0-13.16

T-A Pro Carbide Drill Inserts

0 Series | Diameter Range: 0.4999" - 0.6946" (12.70 mm - 17.64 mm)



Insert								
Series	Fractional Equivalent	D ₁ inch	D ₁ mm	T ₁	Part No. P	Part No. K	Part No. N	Part No. M
0-C	19/32	0.5937	15.08	1/8	TAP0-15.08	TAK0-15.08	TAN0-15.08	TAM0-15.08
0-C		0.5984	15.20	1/8	TAP0-15.20	TAK0-15.20	TAN0-15.20	TAM0-15.20
0-C		0.6004	15.25	1/8	TAP0-15.25	TAK0-15.25	TAN0-15.25	TAM0-15.25
0-C		0.6024	15.30	1/8	TAP0-15.30	TAK0-15.30	TAN0-15.30	TAM0-15.30
0-C		0.6063	15.40	1/8	TAP0-15.40	TAK0-15.40	TAN0-15.40	TAM0-15.40
0-C	39/64	0.6094	15.48	1/8	TAP0-15.48	TAK0-15.48	TAN0-15.48	TAM0-15.48
0-C		0.6102	15.50	1/8	TAP0-15.50	TAK0-15.50	TAN0-15.50	TAM0-15.50
0-C		0.6142	15.60	1/8	TAP0-15.60	TAK0-15.60	TAN0-15.60	TAM0-15.60
0-C		0.6181	15.70	1/8	TAP0-15.70	TAK0-15.70	TAN0-15.70	TAM0-15.70
0-C		0.6220	15.80	1/8	TAP0-15.80	TAK0-15.80	TAN0-15.80	TAM0-15.80
0-C	5/8	0.6252	15.88	1/8	TAP0-15.88	TAK0-15.88	TAN0-15.88	TAM0-15.88
0-C		0.6299	16.00	1/8	TAP0-16.00	TAK0-16.00	TAN0-16.00	TAM0-16.00
0-C		0.6331	16.08	1/8	TAP0-16.08	TAK0-16.08	TAN0-16.08	TAM0-16.08
0-C		0.6378	16.20	1/8	TAP0-16.20	TAK0-16.20	TAN0-16.20	TAM0-16.20
0-C	41/64	0.6406	16.27	1/8	TAP0-16.27	TAK0-16.27	TAN0-16.27	TAM0-16.27
0-C		0.6457	16.40	1/8	TAP0-16.40	TAK0-16.40	TAN0-16.40	TAM0-16.40
0-D		0.6496	16.50	1/8	TAP0-16.50	TAK0-16.50	TAN0-16.50	TAM0-16.50
0-D		0.6535	16.60	1/8	TAP0-16.60	TAK0-16.60	TAN0-16.60	TAM0-16.60
0-D	21/32	0.6563	16.67	1/8	TAP0-16.67	TAK0-16.67	TAN0-16.67	TAM0-16.67
0-D		0.6614	16.80	1/8	TAP0-16.80	TAK0-16.80	TAN0-16.80	TAM0-16.80
0-D		0.6654	16.90	1/8	TAP0-16.90	TAK0-16.90	TAN0-16.90	TAM0-16.90
0-D		0.6693	17.00	1/8	TAP0-17.00	TAK0-17.00	TAN0-17.00	TAM0-17.00
0-D	43/64	0.6720	17.07	1/8	TAP0-17.07	TAK0-17.07	TAN0-17.07	TAM0-17.07
0-D		0.6732	17.10	1/8	TAP0-17.10	TAK0-17.10	TAN0-17.10	TAM0-17.10
0-D		0.6772	17.20	1/8	TAP0-17.20	TAK0-17.20	TAN0-17.20	TAM0-17.20
0-D		0.6811	17.30	1/8	TAP0-17.30	TAK0-17.30	TAN0-17.30	TAM0-17.30
0-D		0.6850	17.40	1/8	TAP0-17.40	TAK0-17.40	TAN0-17.40	TAM0-17.40
0-D	11/16	0.6874	17.46	1/8	TAP0-17.46	TAK0-17.46	TAN0-17.46	TAM0-17.46
0-D		0.6890	17.50	1/8	TAP0-17.50	TAK0-17.50	TAN0-17.50	TAM0-17.50
0-D		0.6929	17.60	1/8	TAP0-17.60	TAK0-17.60	TAN0-17.60	TAM0-17.60

Inserts sold in multiples of 2

Sub Series Holders (A, B, C, D)

Sub series holders are recommended when running carbide inserts toward the upper end of the series drill range, as well as in tougher applications requiring more insert support and holder strength. **NOTE:** Only specified sub series inserts should be used with equivalent or smaller sub series holders.



A Series Insert +
A Series Holder



C Series Insert +
A Series Holder



C Series Insert +
C Series Holder



A Series Insert +
C Series Holder

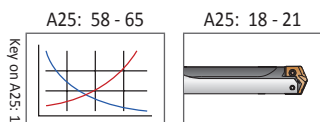

Sizes not shown are available upon request.
When ordering, please follow the example below:

Imperial:	0.5180", Steel, 0 series = use Part No. TAP0-13.16
Metric:	13.16 mm, Steel, 0 series = use Part No. TAP0-13.16

T-A Pro HSS Drill Inserts

0 Series | Diameter Range: 0.4999" - 0.6946" (12.70 mm - 17.64 mm)

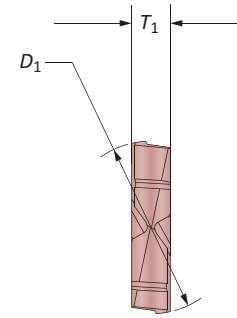
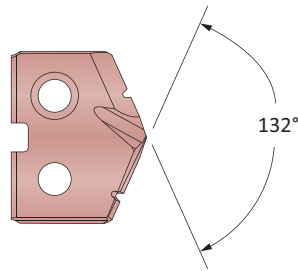

Series	Fractional Equivalent	Insert			Part No.
		D_1 inch	D_1 mm	T_1	
0-A	1/2	0.5000	12.70	1/8	TAX0-12.70
0-A		0.5039	12.80	1/8	TAX0-12.80
0-A		0.5079	12.90	1/8	TAX0-12.90
0-A	33/64	0.5118	13.00	1/8	TAX0-13.00
0-A		0.5157	13.10	1/8	TAX0-13.10
0-A		0.5197	13.20	1/8	TAX0-13.20
0-A		0.5236	13.30	1/8	TAX0-13.30
0-A		0.5276	13.40	1/8	TAX0-13.40
0-A		0.5311	13.49	1/8	TAX0-13.49
0-A	17/32	0.5315	13.50	1/8	TAX0-13.50
0-A		0.5354	13.60	1/8	TAX0-13.60
0-A		0.5394	13.70	1/8	TAX0-13.70
0-A		0.5433	13.80	1/8	TAX0-13.80
0-A		0.5469	13.89	1/8	TAX0-13.89
0-B		0.5512	14.00	1/8	TAX0-14.00
0-B		0.5551	14.10	1/8	TAX0-14.10
0-B	0.5591	14.20	1/8	TAX0-14.20	
0-B	9/16	0.5626	14.29	1/8	TAX0-14.29
0-B		0.5669	14.40	1/8	TAX0-14.40
0-B		0.5709	14.50	1/8	TAX0-14.50
0-B	37/64	0.5748	14.60	1/8	TAX0-14.60
0-B		0.5780	14.68	1/8	TAX0-14.68
0-B		0.5827	14.80	1/8	TAX0-14.80
0-B		0.5866	14.90	1/8	TAX0-14.90
0-B		0.5906	15.00	1/8	TAX0-15.00

Inserts sold in multiples of 2

Sub Series Holders (A, B, C, D)

Sub series holders are recommended when running carbide inserts toward the upper end of the series drill range, as well as in tougher applications requiring more insert support and holder strength. **NOTE:** Only specified sub series inserts should be used with equivalent or smaller sub series holders.



A Series Insert +
A Series Holder



C Series Insert +
A Series Holder



C Series Insert +
C Series Holder



A Series Insert +
C Series Holder

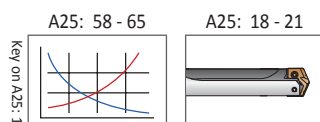

Sizes not shown are available upon request.
When ordering, please follow the example below:

Imperial:	0.5180", Steel, 0 series = use Part No. TAP0-13.16
Metric:	13.16 mm, Steel, 0 series = use Part No. TAP0-13.16

T-A Pro HSS Drill Inserts

0 Series | Diameter Range: 0.4999" - 0.6946" (12.70 mm - 17.64 mm)

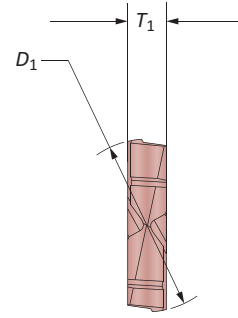
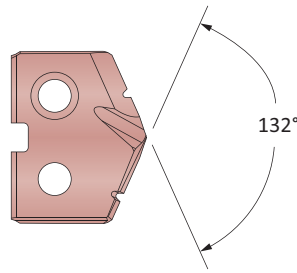

Series	Fractional Equivalent	Insert			Part No.	
		D ₁ inch	D ₁ mm	T ₁		
0-C	19/32	0.5937	15.08	1/8	TAX0-15.08	
0-C		0.5984	15.20	1/8	TAX0-15.20	
0-C		0.6004	15.25	1/8	TAX0-15.25	
0-C		0.6024	15.30	1/8	TAX0-15.30	
0-C		0.6063	15.40	1/8	TAX0-15.40	
0-C	39/64	0.6094	15.48	1/8	TAX0-15.48	
0-C		0.6102	15.50	1/8	TAX0-15.50	
0-C		0.6142	15.60	1/8	TAX0-15.60	
0-C		0.6181	15.70	1/8	TAX0-15.70	
0-C		0.6220	15.80	1/8	TAX0-15.80	
0-C	5/8	0.6252	15.88	1/8	TAX0-15.88	
0-C		0.6299	16.00	1/8	TAX0-16.00	
0-C		0.6331	16.08	1/8	TAX0-16.08	
0-C		0.6378	16.20	1/8	TAX0-16.20	
0-C		0.6406	16.27	1/8	TAX0-16.27	
0-C	41/64	0.6457	16.40	1/8	TAX0-16.40	
0-D		0.6496	16.50	1/8	TAX0-16.50	
0-D		0.6535	16.60	1/8	TAX0-16.60	
0-D		21/32	0.6563	16.67	1/8	TAX0-16.67
0-D			0.6614	16.80	1/8	TAX0-16.80
0-D	0.6654		16.90	1/8	TAX0-16.90	
0-D	0.6693		17.00	1/8	TAX0-17.00	
0-D	43/64		0.6720	17.07	1/8	TAX0-17.07
0-D		0.6732	17.10	1/8	TAX0-17.10	
0-D		0.6772	17.20	1/8	TAX0-17.20	
0-D		0.6811	17.30	1/8	TAX0-17.30	
0-D		0.6850	17.40	1/8	TAX0-17.40	
0-D	11/16	0.6874	17.46	1/8	TAX0-17.46	
0-D		0.6890	17.50	1/8	TAX0-17.50	
0-D		0.6929	17.60	1/8	TAX0-17.60	

Inserts sold in multiples of 2

Sub Series Holders (A, B, C, D)

Sub series holders are recommended when running carbide inserts toward the upper end of the series drill range, as well as in tougher applications requiring more insert support and holder strength. **NOTE:** Only specified sub series inserts should be used with equivalent or smaller sub series holders.



A Series Insert +
A Series Holder



C Series Insert +
A Series Holder



C Series Insert +
C Series Holder



A Series Insert +
C Series Holder

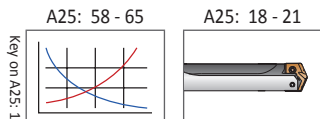

Sizes not shown are available upon request.	
When ordering, please follow the example below:	
Imperial:	0.5180", Steel, 0 series = use Part No. TAP0-13.16
Metric:	13.16 mm, Steel, 0 series = use Part No. TAP0-13.16

T-A Pro Drill Holders

0 Series Imperial | Diameter Range: 0.4999" - 0.6946"

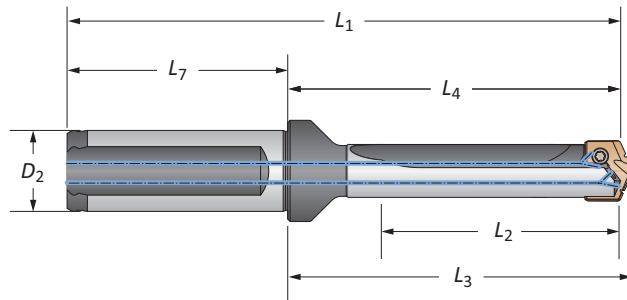

		Body				Shank				
Length	Sub Series	L ₂	L ₄	L ₃	L ₁	L ₇	D ₂	Flat	Part No	
STUB	A	0.603	1.731	1.838	3.761	2.030	3/4	Yes	HTA0A01-075F	
STUB	A	0.603	1.731	1.838	3.761	2.030	3/4	No	HTA0A01-075C	
STUB	B	0.603	1.731	1.838	3.761	2.030	3/4	Yes	HTA0B01-075F	
STUB	B	0.603	1.731	1.838	3.761	2.030	3/4	No	HTA0B01-075C	
STUB	C	0.603	1.731	1.838	3.761	2.030	3/4	Yes	HTA0C01-075F	
STUB	C	0.603	1.731	1.838	3.761	2.030	3/4	No	HTA0C01-075C	
STUB	D	0.603	1.731	1.838	3.761	2.030	3/4	Yes	HTA0D01-075F	
STUB	D	0.603	1.731	1.838	3.761	2.030	3/4	No	HTA0D01-075C	
3xD	A	1.809	3.064	3.171	5.094	2.030	3/4	Yes	HTA0A03-075F	
3xD	A	1.809	3.064	3.171	5.094	2.030	3/4	No	HTA0A03-075C	
3xD	B	1.809	3.064	3.171	5.094	2.030	3/4	Yes	HTA0B03-075F	
3xD	B	1.809	3.064	3.171	5.094	2.030	3/4	No	HTA0B03-075C	
3xD	C	1.809	3.064	3.171	5.094	2.030	3/4	Yes	HTA0C03-075F	
3xD	C	1.809	3.064	3.171	5.094	2.030	3/4	No	HTA0C03-075C	
3xD	D	1.809	3.064	3.171	5.094	2.030	3/4	Yes	HTA0D03-075F	
3xD	D	1.809	3.064	3.171	5.094	2.030	3/4	No	HTA0D03-075C	
5xD	A	3.015	4.270	4.377	6.300	2.030	3/4	Yes	HTA0A05-075F	
5xD	A	3.015	4.270	4.377	6.300	2.030	3/4	No	HTA0A05-075C	
5xD	B	3.015	4.270	4.377	6.300	2.030	3/4	Yes	HTA0B05-075F	
5xD	B	3.015	4.270	4.377	6.300	2.030	3/4	No	HTA0B05-075C	
5xD	C	3.015	4.270	4.377	6.300	2.030	3/4	Yes	HTA0C05-075F	
5xD	C	3.015	4.270	4.377	6.300	2.030	3/4	No	HTA0C05-075C	
5xD	D	3.015	4.270	4.377	6.300	2.030	3/4	Yes	HTA0D05-075F	
5xD	D	3.015	4.270	4.377	6.300	2.030	3/4	No	HTA0D05-075C	
7xD	A	4.221	5.476	5.583	7.506	2.030	3/4	Yes	HTA0A07-075F	
7xD	A	4.221	5.476	5.583	7.506	2.030	3/4	No	HTA0A07-075C	
7xD	B	4.221	5.476	5.583	7.506	2.030	3/4	Yes	HTA0B07-075F	
7xD	B	4.221	5.476	5.583	7.506	2.030	3/4	No	HTA0B07-075C	
7xD	C	4.221	5.476	5.583	7.506	2.030	3/4	Yes	HTA0C07-075F	
7xD	C	4.221	5.476	5.583	7.506	2.030	3/4	No	HTA0C07-075C	
7xD	D	4.221	5.476	5.583	7.506	2.030	3/4	Yes	HTA0D07-075F	
7xD	D	4.221	5.476	5.583	7.506	2.030	3/4	No	HTA0D07-075C	

Connection Accessories

	Insert Screws	Nylon Locking Screws	Insert Driver	Preset Torque Hand Driver	Replacement Tips	Admissible Tightening Torque*
A/B	72556-IP8-1	72556N-IP8-1	8IP-8	8IP-8TL	8IP-8B	15.5 in-lbs (175 N-cm)
C/D	72567-IP8-1	72567N-IP8-1	8IP-8	8IP-8TL	8IP-8B	15.5 in-lbs (175 N-cm)

*Tightening torques are calculated with a friction coefficient of $\mu = 0.14$ and develop 90% of ultimate yield strength

⚠ WARNING Refer to Speed and Feed charts for recommended adjustments to speeds and feeds. Refer to page A25: 68 for deep hole drilling guidelines in this section of the catalog. Visit www.alliedmachine.com/DeepHoleGuidelines for the most up-to-date information and procedures. Factory technical assistance is available for your specific applications through our Application Engineering department. ext: 7611 | email: appeng@alliedmachine.com

A25: 58 - 65 A25: 14 - 15 A25: 16 - 17

Key on A25: 1

i = Imperial (in)
m = Metric (mm)

Screws sold in multiples of 10



T-A Pro Drill Holders

0 Series Imperial | Diameter Range: 0.4999" - 0.6946"

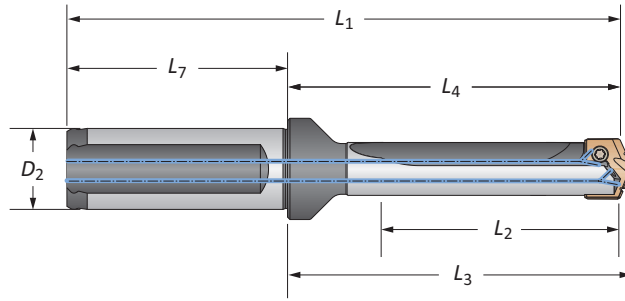

Length	Sub Series	Body				Shank			Flat	Part No
		L ₂	L ₄	L ₃	L ₁	L ₇	D ₂			
10xD	A	6.030	7.285	7.392	9.315	2.030	3/4	Yes	HTA0A10-075F	
10xD	A	6.030	7.285	7.392	9.315	2.030	3/4	No	HTA0A10-075C	
10xD	B	6.030	7.285	7.392	9.315	2.030	3/4	Yes	HTA0B10-075F	
10xD	B	6.030	7.285	7.392	9.315	2.030	3/4	No	HTA0B10-075C	
10xD	C	6.030	7.285	7.392	9.315	2.030	3/4	Yes	HTA0C10-075F	
10xD	C	6.030	7.285	7.392	9.315	2.030	3/4	No	HTA0C10-075C	
10xD	D	6.030	7.285	7.392	9.315	2.030	3/4	Yes	HTA0D10-075F	
10xD	D	6.030	7.285	7.392	9.315	2.030	3/4	No	HTA0D10-075C	
12xD	A	7.236	8.491	8.598	10.521	2.030	3/4	Yes	HTA0A12-075F	
12xD	A	7.236	8.491	8.598	10.521	2.030	3/4	No	HTA0A12-075C	
12xD	B	7.236	8.491	8.598	10.521	2.030	3/4	Yes	HTA0B12-075F	
12xD	B	7.236	8.491	8.598	10.521	2.030	3/4	No	HTA0B12-075C	
12xD	C	7.236	8.491	8.598	10.521	2.030	3/4	Yes	HTA0C12-075F	
12xD	C	7.236	8.491	8.598	10.521	2.030	3/4	No	HTA0C12-075C	
12xD	D	7.236	8.491	8.598	10.521	2.030	3/4	Yes	HTA0D12-075F	
12xD	D	7.236	8.491	8.598	10.521	2.030	3/4	No	HTA0D12-075C	
15xD	A	9.045	10.300	10.407	12.330	2.030	3/4	Yes	HTA0A15-075F	
15xD	A	9.045	10.300	10.407	12.330	2.030	3/4	No	HTA0A15-075C	
15xD	B	9.045	10.300	10.407	12.330	2.030	3/4	Yes	HTA0B15-075F	
15xD	B	9.045	10.300	10.407	12.330	2.030	3/4	No	HTA0B15-075C	
15xD	C	9.045	10.300	10.407	12.330	2.030	3/4	Yes	HTA0C15-075F	
15xD	C	9.045	10.300	10.407	12.330	2.030	3/4	No	HTA0C15-075C	
15xD	D	9.045	10.300	10.407	12.330	2.030	3/4	Yes	HTA0D15-075F	
15xD	D	9.045	10.300	10.407	12.330	2.030	3/4	No	HTA0D15-075C	

Connection Accessories

	Insert Screws	Nylon Locking Screws	Insert Driver	Preset Torque Hand Driver	Replacement Tips	Admissible Tightening Torque*
A/B	72556-IP8-1	72556N-IP8-1	8IP-8	8IP-8TL	8IP-8B	15.5 in-lbs (175 N-cm)
C/D	72567-IP8-1	72567N-IP8-1	8IP-8	8IP-8TL	8IP-8B	15.5 in-lbs (175 N-cm)

*Tightening torques are calculated with a friction coefficient of $\mu = 0.14$ and develop 90% of ultimate yield strength

⚠ WARNING Refer to Speed and Feed charts for recommended adjustments to speeds and feeds. Refer to page A25: 68 for deep hole drilling guidelines in this section of the catalog. Visit www.alliedmachine.com/DeepHoleGuidelines for the most up-to-date information and procedures. Factory technical assistance is available for your specific applications through our Application Engineering department. ext: 7611 | email: appeng@alliedmachine.com

A25: 58 - 65

Key on A25: 1

A25: 14 - 15

A25: 16 - 17

ⓘ = Imperial (in)
Ⓜ = Metric (mm)

Screws sold in multiples of 10

T-A Pro Drill Holders

0 Series Metric | Diameter Range: 12.70 mm - 17.64 mm

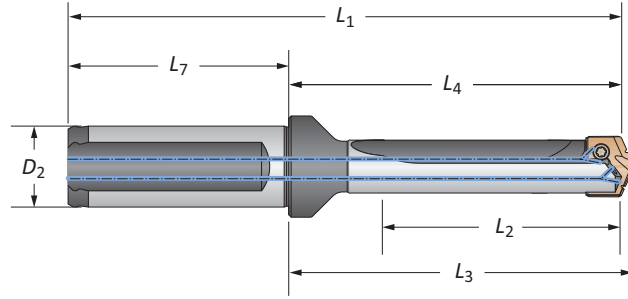

		Body				Shank			
Length	Sub Series	L ₂	L ₄	L ₃	L ₁	L ₇	D ₂	Flat	Part No
STUB	A	15.3	44.0	46.7	95.5	50.0	20	Yes	HTA0A01-20FM
STUB	A	15.3	44.0	46.7	95.5	50.0	20	No	HTA0A01-20CM
STUB	B	15.3	44.0	46.7	95.5	50.0	20	Yes	HTA0B01-20FM
STUB	B	15.3	44.0	46.7	95.5	50.0	20	No	HTA0B01-20CM
STUB	C	15.3	44.0	46.7	95.5	50.0	20	Yes	HTA0C01-20FM
STUB	C	15.3	44.0	46.7	95.5	50.0	20	No	HTA0C01-20CM
STUB	D	15.3	44.0	46.7	95.5	50.0	20	Yes	HTA0D01-20FM
STUB	D	15.3	44.0	46.7	95.5	50.0	20	No	HTA0D01-20CM
3xD	A	45.9	77.8	80.5	129.4	50.0	20	Yes	HTA0A03-20FM
3xD	A	45.9	77.8	80.5	129.4	50.0	20	No	HTA0A03-20CM
3xD	B	45.9	77.8	80.5	129.4	50.0	20	Yes	HTA0B03-20FM
3xD	B	45.9	77.8	80.5	129.4	50.0	20	No	HTA0B03-20CM
3xD	C	45.9	77.8	80.5	129.4	50.0	20	Yes	HTA0C03-20FM
3xD	C	45.9	77.8	80.5	129.4	50.0	20	No	HTA0C03-20CM
3xD	D	45.9	77.8	80.5	129.4	50.0	20	Yes	HTA0D03-20FM
3xD	D	45.9	77.8	80.5	129.4	50.0	20	No	HTA0D03-20CM
5xD	A	76.6	108.5	111.2	160.0	50.0	20	Yes	HTA0A05-20FM
5xD	A	76.6	108.5	111.2	160.0	50.0	20	No	HTA0A05-20CM
5xD	B	76.6	108.5	111.2	160.0	50.0	20	Yes	HTA0B05-20FM
5xD	B	76.6	108.5	111.2	160.0	50.0	20	No	HTA0B05-20CM
5xD	C	76.6	108.5	111.2	160.0	50.0	20	Yes	HTA0C05-20FM
5xD	C	76.6	108.5	111.2	160.0	50.0	20	No	HTA0C05-20CM
5xD	D	76.6	108.5	111.2	160.0	50.0	20	Yes	HTA0D05-20FM
5xD	D	76.6	108.5	111.2	160.0	50.0	20	No	HTA0D05-20CM
7xD	A	107.2	139.1	141.8	190.7	50.0	20	Yes	HTA0A07-20FM
7xD	A	107.2	139.1	141.8	190.7	50.0	20	No	HTA0A07-20CM
7xD	B	107.2	139.1	141.8	190.7	50.0	20	Yes	HTA0B07-20FM
7xD	B	107.2	139.1	141.8	190.7	50.0	20	No	HTA0B07-20CM
7xD	C	107.2	139.1	141.8	190.7	50.0	20	Yes	HTA0C07-20FM
7xD	C	107.2	139.1	141.8	190.7	50.0	20	No	HTA0C07-20CM
7xD	D	107.2	139.1	141.8	190.7	50.0	20	Yes	HTA0D07-20FM
7xD	D	107.2	139.1	141.8	190.7	50.0	20	No	HTA0D07-20CM

Connection Accessories

	Insert Screws	Nylon Locking Screws	Insert Driver	Preset Torque Hand Driver	Replacement Tips	Admissible Tightening Torque*
A/B	72556-IP8-1	72556N-IP8-1	8IP-8	8IP-8TL	8IP-8B	15.5 in-lbs (175 N-cm)
C/D	72567-IP8-1	72567N-IP8-1	8IP-8	8IP-8TL	8IP-8B	15.5 in-lbs (175 N-cm)

*Tightening torques are calculated with a friction coefficient of $\mu = 0.14$ and develop 90% of ultimate yield strength

⚠ WARNING Refer to Speed and Feed charts for recommended adjustments to speeds and feeds. Refer to page A25: 68 for deep hole drilling guidelines in this section of the catalog. Visit www.alliedmachine.com/DeepHoleGuidelines for the most up-to-date information and procedures. Factory technical assistance is available for your specific applications through our Application Engineering department. **ext: 7611 | email: appeng@alliedmachine.com**

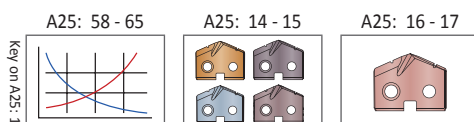

i = Imperial (in)
m = Metric (mm)

Screws sold in multiples of 10



T-A Pro Drill Holders

0 Series Metric | Diameter Range: 12.70 mm - 17.64 mm

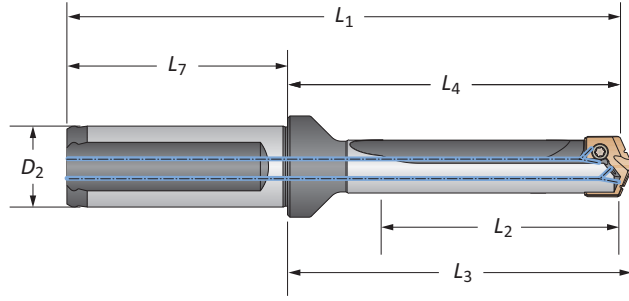

Length	Sub Series	Body				Shank				Part No
		L ₂	L ₄	L ₃	L ₁	L ₇	D ₂	Flat		
10xD	A	153.2	185.0	187.8	236.6	50.0	20	Yes	HTA0A10-20FM	
10xD	A	153.2	185.0	187.8	236.6	50.0	20	No	HTA0A10-20CM	
10xD	B	153.2	185.0	187.8	236.6	50.0	20	Yes	HTA0B10-20FM	
10xD	B	153.2	185.0	187.8	236.6	50.0	20	No	HTA0B10-20CM	
10xD	C	153.2	185.0	187.8	236.6	50.0	20	Yes	HTA0C10-20FM	
10xD	C	153.2	185.0	187.8	236.6	50.0	20	No	HTA0C10-20CM	
10xD	D	153.2	185.0	187.8	236.6	50.0	20	Yes	HTA0D10-20FM	
10xD	D	153.2	185.0	187.8	236.6	50.0	20	No	HTA0D10-20CM	
12xD	A	183.8	215.7	218.4	267.2	50.0	20	Yes	HTA0A12-20FM	
12xD	A	183.8	215.7	218.4	267.2	50.0	20	No	HTA0A12-20CM	
12xD	B	183.8	215.7	218.4	267.2	50.0	20	Yes	HTA0B12-20FM	
12xD	B	183.8	215.7	218.4	267.2	50.0	20	No	HTA0B12-20CM	
12xD	C	183.8	215.7	218.4	267.2	50.0	20	Yes	HTA0C12-20FM	
12xD	C	183.8	215.7	218.4	267.2	50.0	20	No	HTA0C12-20CM	
12xD	D	183.8	215.7	218.4	267.2	50.0	20	Yes	HTA0D12-20FM	
12xD	D	183.8	215.7	218.4	267.2	50.0	20	No	HTA0D12-20CM	
15xD	A	229.7	261.6	264.3	313.2	50.0	20	Yes	HTA0A15-20FM	
15xD	A	229.7	261.6	264.3	313.2	50.0	20	No	HTA0A15-20CM	
15xD	B	229.7	261.6	264.3	313.2	50.0	20	Yes	HTA0B15-20FM	
15xD	B	229.7	261.6	264.3	313.2	50.0	20	No	HTA0B15-20CM	
15xD	C	229.7	261.6	264.3	313.2	50.0	20	Yes	HTA0C15-20FM	
15xD	C	229.7	261.6	264.3	313.2	50.0	20	No	HTA0C15-20CM	
15xD	D	229.7	261.6	264.3	313.2	50.0	20	Yes	HTA0D15-20FM	
15xD	D	229.7	261.6	264.3	313.2	50.0	20	No	HTA0D15-20CM	

Connection Accessories

	Insert Screws	Nylon Locking Screws	Insert Driver	Preset Torque Hand Driver	Replacement Tips	Admissible Tightening Torque*
A/B	72556-IP8-1	72556N-IP8-1	8IP-8	8IP-8TL	8IP-8B	15.5 in-lbs (175 N-cm)
C/D	72567-IP8-1	72567N-IP8-1	8IP-8	8IP-8TL	8IP-8B	15.5 in-lbs (175 N-cm)

*Tightening torques are calculated with a friction coefficient of $\mu = 0.14$ and develop 90% of ultimate yield strength

WARNING Refer to Speed and Feed charts for recommended adjustments to speeds and feeds. Refer to page A25: 68 for deep hole drilling guidelines in this section of the catalog. Visit www.alliedmachine.com/DeepHoleGuidelines for the most up-to-date information and procedures. Factory technical assistance is available for your specific applications through our Application Engineering department. ext: 7611 | email: appeng@alliedmachine.com

A25: 58 - 65 A25: 14 - 15 A25: 16 - 17

Key on A25: 1





ⓘ = Imperial (in)
Ⓜ = Metric (mm)

Screws sold in multiples of 10

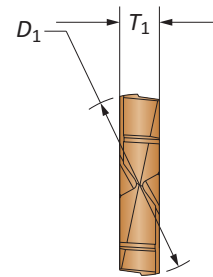
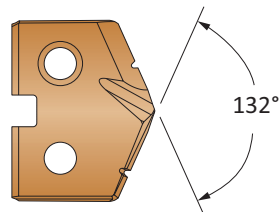
T-A Pro Carbide Drill Inserts

1 Series | Diameter Range: 0.6947" - 0.9596" (17.65 mm - 24.37 mm)



Series	Fractional Equivalent	Insert						
		D_1 inch	D_1 mm	T_1	Part No. P	Part No. K	Part No. N	Part No. M
1-A		0.6969	17.70	5/32	TAP1-17.70	TAK1-17.70	TAN1-17.70	TAM1-17.70
1-A		0.7008	17.80	5/32	TAP1-17.80	TAK1-17.80	TAN1-17.80	TAM1-17.80
1-A	45/64	0.7031	17.86	5/32	TAP1-17.86	TAK1-17.86	TAN1-17.86	TAM1-17.86
1-A		0.7047	17.90	5/32	TAP1-17.90	TAK1-17.90	TAN1-17.90	TAM1-17.90
1-A		0.7087	18.00	5/32	TAP1-18.00	TAK1-18.00	TAN1-18.00	TAM1-18.00
1-A		0.7126	18.10	5/32	TAP1-18.10	TAK1-18.10	TAN1-18.10	TAM1-18.10
1-A		0.7165	18.20	5/32	TAP1-18.20	TAK1-18.20	TAN1-18.20	TAM1-18.20
1-A	23/32	0.7189	18.26	5/32	TAP1-18.26	TAK1-18.26	TAN1-18.26	TAM1-18.26
1-A		0.7205	18.30	5/32	TAP1-18.30	TAK1-18.30	TAN1-18.30	TAM1-18.30
1-A		0.7244	18.40	5/32	TAP1-18.40	TAK1-18.40	TAN1-18.40	TAM1-18.40
1-A		0.7283	18.50	5/32	TAP1-18.50	TAK1-18.50	TAN1-18.50	TAM1-18.50
1-A		0.7323	18.60	5/32	TAP1-18.60	TAK1-18.60	TAN1-18.60	TAM1-18.60
1-A	47/64	0.7343	18.65	5/32	TAP1-18.65	TAK1-18.65	TAN1-18.65	TAM1-18.65
1-A		0.7362	18.70	5/32	TAP1-18.70	TAK1-18.70	TAN1-18.70	TAM1-18.70
1-A		0.7402	18.80	5/32	TAP1-18.80	TAK1-18.80	TAN1-18.80	TAM1-18.80
1-A		0.7441	18.90	5/32	TAP1-18.90	TAK1-18.90	TAN1-18.90	TAM1-18.90
1-A		0.7480	19.00	5/32	TAP1-19.00	TAK1-19.00	TAN1-19.00	TAM1-19.00

Inserts sold in multiples of 2

Sub Series Holders (A, B, C, D)

Sub series holders are recommended when running carbide inserts toward the upper end of the series drill range, as well as in tougher applications requiring more insert support and holder strength. **NOTE:** Only specified sub series inserts should be used with equivalent or smaller sub series holders.



A Series Insert +
A Series Holder



C Series Insert +
A Series Holder



C Series Insert +
C Series Holder



A Series Insert +
C Series Holder

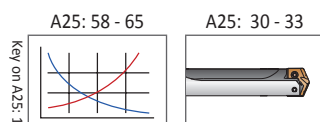





Sizes not shown are available upon request.
When ordering, please follow the example below:

Imperial:	0.5180", Steel, 0 series = use Part No. TAP0-13.16
Metric:	13.16 mm, Steel, 0 series = use Part No. TAP0-13.16

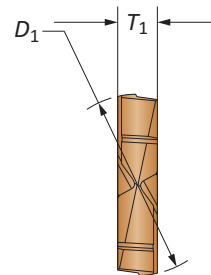
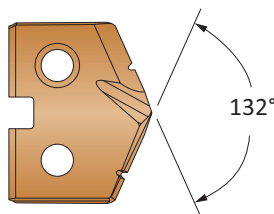
T-A Pro Carbide Drill Inserts

1 Series | Diameter Range: 0.6947" - 0.9596" (17.65 mm - 24.37 mm)



Series	Fractional Equivalent	Insert						
		D_1 inch	D_1 mm	T_1	Part No. P	Part No. K	Part No. N	Part No. M
1-B	3/4	0.7500	19.05	5/32	TAP1-19.05	TAK1-19.05	TAN1-19.05	TAM1-19.05
1-B		0.7520	19.10	5/32	TAP1-19.10	TAK1-19.10	TAN1-19.10	TAM1-19.10
1-B		0.7559	19.20	5/32	TAP1-19.20	TAK1-19.20	TAN1-19.20	TAM1-19.20
1-B		0.7579	19.25	5/32	TAP1-19.25	TAK1-19.25	TAN1-19.25	TAM1-19.25
1-B		0.7598	19.30	5/32	TAP1-19.30	TAK1-19.30	TAN1-19.30	TAM1-19.30
1-B		0.7638	19.40	5/32	TAP1-19.40	TAK1-19.40	TAN1-19.40	TAM1-19.40
1-B	49/64	0.7657	19.45	5/32	TAP1-19.45	TAK1-19.45	TAN1-19.45	TAM1-19.45
1-B		0.7677	19.50	5/32	TAP1-19.50	TAK1-19.50	TAN1-19.50	TAM1-19.50
1-B		0.7717	19.60	5/32	TAP1-19.60	TAK1-19.60	TAN1-19.60	TAM1-19.60
1-B		0.7756	19.70	5/32	TAP1-19.70	TAK1-19.70	TAN1-19.70	TAM1-19.70
1-B		0.7795	19.80	5/32	TAP1-19.80	TAK1-19.80	TAN1-19.80	TAM1-19.80
1-B	25/32	0.7811	19.84	5/32	TAP1-19.84	TAK1-19.84	TAN1-19.84	TAM1-19.84
1-B		0.7835	19.90	5/32	TAP1-19.90	TAK1-19.90	TAN1-19.90	TAM1-19.90
1-B		0.7874	20.00	5/32	TAP1-20.00	TAK1-20.00	TAN1-20.00	TAM1-20.00
1-B		0.7913	20.10	5/32	TAP1-20.10	TAK1-20.10	TAN1-20.10	TAM1-20.10
1-B		0.7953	20.20	5/32	TAP1-20.20	TAK1-20.20	TAN1-20.20	TAM1-20.20
1-B	51/64	0.7969	20.24	5/32	TAP1-20.24	TAK1-20.24	TAN1-20.24	TAM1-20.24
1-B		0.7992	20.30	5/32	TAP1-20.30	TAK1-20.30	TAN1-20.30	TAM1-20.30
1-B		0.8031	20.40	5/32	TAP1-20.40	TAK1-20.40	TAN1-20.40	TAM1-20.40
1-B		0.8071	20.50	5/32	TAP1-20.50	TAK1-20.50	TAN1-20.50	TAM1-20.50

Inserts sold in multiples of 2

Sub Series Holders (A, B, C, D)

Sub series holders are recommended when running carbide inserts toward the upper end of the series drill range, as well as in tougher applications requiring more insert support and holder strength. **NOTE:** Only specified sub series inserts should be used with equivalent or smaller sub series holders.



A Series Insert +
A Series Holder



C Series Insert +
A Series Holder



C Series Insert +
C Series Holder



A Series Insert +
C Series Holder

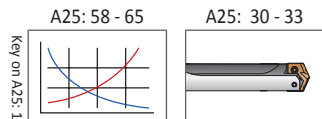



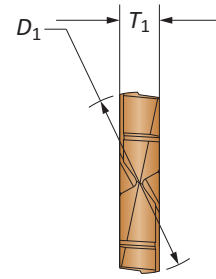
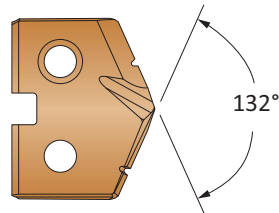

Sizes not shown are available upon request.	
When ordering, please follow the example below:	
Imperial:	0.5180", Steel, 0 series = use Part No. TAP0-13.16
Metric:	13.16 mm, Steel, 0 series = use Part No. TAP0-13.16

T-A Pro Carbide Drill Inserts

1 Series | Diameter Range: 0.6947" - 0.9596" (17.65 mm - 24.37 mm)



Insert								
Series	Fractional Equivalent	D_1 inch	D_1 mm	T_1	Part No. P	Part No. K	Part No. N	Part No. M
1-C		0.8110	20.60	5/32	TAP1-20.60	TAK1-20.60	TAN1-20.60	TAM1-20.60
1-C	13/16	0.8126	20.64	5/32	TAP1-20.64	TAK1-20.64	TAN1-20.64	TAM1-20.64
1-C		0.8150	20.70	5/32	TAP1-20.70	TAK1-20.70	TAN1-20.70	TAM1-20.70
1-C		0.8189	20.80	5/32	TAP1-20.80	TAK1-20.80	TAN1-20.80	TAM1-20.80
1-C		0.8228	20.90	5/32	TAP1-20.90	TAK1-20.90	TAN1-20.90	TAM1-20.90
1-C		0.8268	21.00	5/32	TAP1-21.00	TAK1-21.00	TAN1-21.00	TAM1-21.00
1-C		0.8307	21.10	5/32	TAP1-21.10	TAK1-21.10	TAN1-21.10	TAM1-21.10
1-C		0.8346	21.20	5/32	TAP1-21.20	TAK1-21.20	TAN1-21.20	TAM1-21.20
1-C		0.8386	21.30	5/32	TAP1-21.30	TAK1-21.30	TAN1-21.30	TAM1-21.30
1-C		0.8425	21.40	5/32	TAP1-21.40	TAK1-21.40	TAN1-21.40	TAM1-21.40
1-C	27/32	0.8437	21.43	5/32	TAP1-21.43	TAK1-21.43	TAN1-21.43	TAM1-21.43
1-C		0.8465	21.50	5/32	TAP1-21.50	TAK1-21.50	TAN1-21.50	TAM1-21.50
1-C		0.8504	21.60	5/32	TAP1-21.60	TAK1-21.60	TAN1-21.60	TAM1-21.60
1-C		0.8543	21.70	5/32	TAP1-21.70	TAK1-21.70	TAN1-21.70	TAM1-21.70
1-C		0.8583	21.80	5/32	TAP1-21.80	TAK1-21.80	TAN1-21.80	TAM1-21.80
1-C	55/64	0.8594	21.83	5/32	TAP1-21.83	TAK1-21.83	TAN1-21.83	TAM1-21.83
1-C		0.8622	21.90	5/32	TAP1-21.90	TAK1-21.90	TAN1-21.90	TAM1-21.90
1-C		0.8661	22.00	5/32	TAP1-22.00	TAK1-22.00	TAN1-22.00	TAM1-22.00
1-C		0.8701	22.10	5/32	TAP1-22.10	TAK1-22.10	TAN1-22.10	TAM1-22.10
1-C		0.8740	22.20	5/32	TAP1-22.20	TAK1-22.20	TAN1-22.20	TAM1-22.20
1-C	7/8	0.8752	22.23	5/32	TAP1-22.23	TAK1-22.23	TAN1-22.23	TAM1-22.23
1-C		0.8780	22.30	5/32	TAP1-22.30	TAK1-22.30	TAN1-22.30	TAM1-22.30
1-C		0.8819	22.40	5/32	TAP1-22.40	TAK1-22.40	TAN1-22.40	TAM1-22.40
1-C		0.8858	22.50	5/32	TAP1-22.50	TAK1-22.50	TAN1-22.50	TAM1-22.50
1-C	57/64	0.8906	22.62	5/32	TAP1-22.62	TAK1-22.62	TAN1-22.62	TAM1-22.62
1-C		0.8937	22.70	5/32	TAP1-22.70	TAK1-22.70	TAN1-22.70	TAM1-22.70
1-C		0.8976	22.80	5/32	TAP1-22.80	TAK1-22.80	TAN1-22.80	TAM1-22.80

Inserts sold in multiples of 2

Sub Series Holders (A, B, C, D)

Sub series holders are recommended when running carbide inserts toward the upper end of the series drill range, as well as in tougher applications requiring more insert support and holder strength. **NOTE:** Only specified sub series inserts should be used with equivalent or smaller sub series holders.



A Series Insert +
A Series Holder



C Series Insert +
A Series Holder



C Series Insert +
C Series Holder



A Series Insert +
C Series Holder

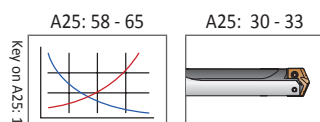

A25: 24





Sizes not shown are available upon request.
When ordering, please follow the example below:

Imperial:	0.5180", Steel, 0 series = use Part No. TAP0-13.16
Metric:	13.16 mm, Steel, 0 series = use Part No. TAP0-13.16

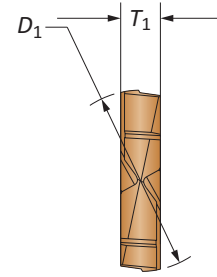
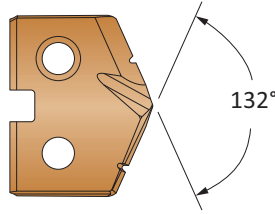
T-A Pro Carbide Drill Inserts

1 Series | Diameter Range: 0.6947" - 0.9596" (17.65 mm - 24.37 mm)



Series	Fractional Equivalent	Insert						
		D_1 inch	D_1 mm	T_1	Part No.	Part No.	Part No.	Part No.
					P	K	N	M
1-D		0.9016	22.90	5/32	TAP1-22.90	TAK1-22.90	TAN1-22.90	TAM1-22.90
1-D		0.9055	23.00	5/32	TAP1-23.00	TAK1-23.00	TAN1-23.00	TAM1-23.00
1-D	29/32	0.9063	23.02	5/32	TAP1-23.02	TAK1-23.02	TAN1-23.02	TAM1-23.02
1-D		0.9094	23.10	5/32	TAP1-23.10	TAK1-23.10	TAN1-23.10	TAM1-23.10
1-D		0.9134	23.20	5/32	TAP1-23.20	TAK1-23.20	TAN1-23.20	TAM1-23.20
1-D		0.9173	23.30	5/32	TAP1-23.30	TAK1-23.30	TAN1-23.30	TAM1-23.30
1-D	59/64	0.9220	23.42	5/32	TAP1-23.42	TAK1-23.42	TAN1-23.42	TAM1-23.42
1-D		0.9252	23.50	5/32	TAP1-23.50	TAK1-23.50	TAN1-23.50	TAM1-23.50
1-D		0.9291	23.60	5/32	TAP1-23.60	TAK1-23.60	TAN1-23.60	TAM1-23.60
1-D		0.9331	23.70	5/32	TAP1-23.70	TAK1-23.70	TAN1-23.70	TAM1-23.70
1-D	15/16	0.9374	23.81	5/32	TAP1-23.81	TAK1-23.81	TAN1-23.81	TAM1-23.81
1-D		0.9409	23.90	5/32	TAP1-23.90	TAK1-23.90	TAN1-23.90	TAM1-23.90
1-D		0.9449	24.00	5/32	TAP1-24.00	TAK1-24.00	TAN1-24.00	TAM1-24.00
1-D		0.9488	24.10	5/32	TAP1-24.10	TAK1-24.10	TAN1-24.10	TAM1-24.10
1-D		0.9528	24.20	5/32	TAP1-24.20	TAK1-24.20	TAN1-24.20	TAM1-24.20
1-D		0.9567	24.30	5/32	TAP1-24.30	TAK1-24.30	TAN1-24.30	TAM1-24.30

Inserts sold in multiples of 2

Sub Series Holders (A, B, C, D)

Sub series holders are recommended when running carbide inserts toward the upper end of the series drill range, as well as in tougher applications requiring more insert support and holder strength. **NOTE:** Only specified sub series inserts should be used with equivalent or smaller sub series holders.



A Series Insert +
A Series Holder



C Series Insert +
A Series Holder



C Series Insert +
C Series Holder



A Series Insert +
C Series Holder

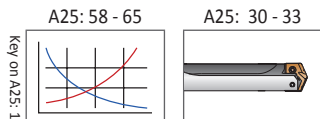

Sizes not shown are available upon request. When ordering, please follow the example below:	
Imperial:	0.5180", Steel, 0 series = use Part No. TAP0-13.16
Metric:	13.16 mm, Steel, 0 series = use Part No. TAP0-13.16

T-A Pro HSS Drill Inserts

1 Series | Diameter Range: 0.6947" - 0.9596" (17.65 mm - 24.37 mm)

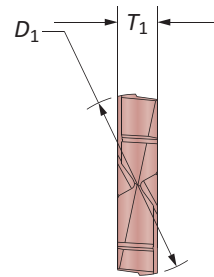
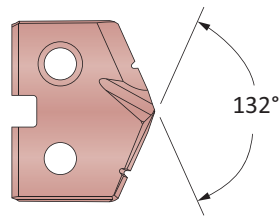
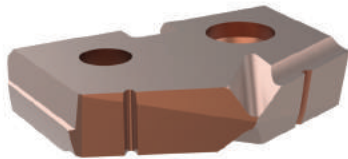

Series	Fractional Equivalent	Insert			Part No.
		D_1 inch	D_1 mm	T_1	
1-A		0.6969	17.70	5/32	TAX1-17.70
1-A		0.7008	17.80	5/32	TAX1-17.80
1-A	45/64	0.7031	17.86	5/32	TAX1-17.86
1-A		0.7047	17.90	5/32	TAX1-17.90
1-A		0.7087	18.00	5/32	TAX1-18.00
1-A		0.7126	18.10	5/32	TAX1-18.10
1-A		0.7165	18.20	5/32	TAX1-18.20
1-A	23/32	0.7189	18.26	5/32	TAX1-18.26
1-A		0.7205	18.30	5/32	TAX1-18.30
1-A		0.7244	18.40	5/32	TAX1-18.40
1-A		0.7283	18.50	5/32	TAX1-18.50
1-A		0.7323	18.60	5/32	TAX1-18.60
1-A	47/64	0.7343	18.65	5/32	TAX1-18.65
1-A		0.7362	18.70	5/32	TAX1-18.70
1-A		0.7402	18.80	5/32	TAX1-18.80
1-A		0.7441	18.90	5/32	TAX1-18.90
1-A		0.7480	19.00	5/32	TAX1-19.00

Inserts sold in multiples of 2

Sub Series Holders (A, B, C, D)

Sub series holders are recommended when running carbide inserts toward the upper end of the series drill range, as well as in tougher applications requiring more insert support and holder strength. **NOTE:** Only specified sub series inserts should be used with equivalent or smaller sub series holders.



A Series Insert +
A Series Holder



C Series Insert +
A Series Holder



C Series Insert +
C Series Holder



A Series Insert +
C Series Holder

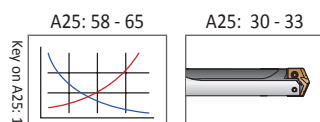

Sizes not shown are available upon request.
When ordering, please follow the example below:

Imperial:	0.5180", Steel, 0 series = use Part No. TAP0-13.16
Metric:	13.16 mm, Steel, 0 series = use Part No. TAP0-13.16



T-A Pro HSS Drill Inserts

1 Series | Diameter Range: 0.6947" - 0.9596" (17.65 mm - 24.37 mm)

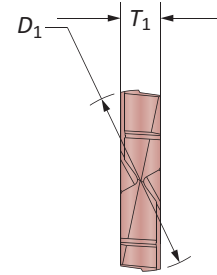
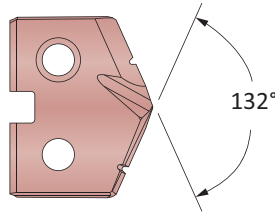
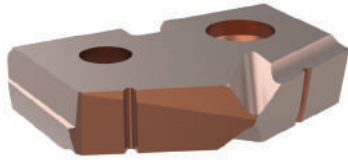

Series	Fractional Equivalent	Insert			Part No.	
		D ₁ inch	D ₁ mm	T ₁		
1-B	3/4	0.7500	19.05	5/32	TAX1-19.05	
1-B		0.7520	19.10	5/32	TAX1-19.10	
1-B		0.7559	19.20	5/32	TAX1-19.20	
1-B		0.7579	19.25	5/32	TAX1-19.25	
1-B		0.7598	19.30	5/32	TAX1-19.30	
1-B		0.7638	19.40	5/32	TAX1-19.40	
1-B		49/64	0.7657	19.45	5/32	TAX1-19.45
1-B	0.7677		19.50	5/32	TAX1-19.50	
1-B	0.7717		19.60	5/32	TAX1-19.60	
1-B	0.7756		19.70	5/32	TAX1-19.70	
1-B	0.7795		19.80	5/32	TAX1-19.80	
1-B	25/32		0.7811	19.84	5/32	TAX1-19.84
1-B			0.7835	19.90	5/32	TAX1-19.90
1-B		0.7874	20.00	5/32	TAX1-20.00	
1-B		0.7913	20.10	5/32	TAX1-20.10	
1-B		0.7953	20.20	5/32	TAX1-20.20	
1-B		51/64	0.7969	20.24	5/32	TAX1-20.24
1-B			0.7992	20.30	5/32	TAX1-20.30
1-B	0.8031		20.40	5/32	TAX1-20.40	
1-B	0.8071		20.50	5/32	TAX1-20.50	

Inserts sold in multiples of 2

Sub Series Holders (A, B, C, D)

Sub series holders are recommended when running carbide inserts toward the upper end of the series drill range, as well as in tougher applications requiring more insert support and holder strength. **NOTE:** Only specified sub series inserts should be used with equivalent or smaller sub series holders.



A Series Insert + A Series Holder



C Series Insert + A Series Holder



C Series Insert + C Series Holder



A Series Insert + C Series Holder

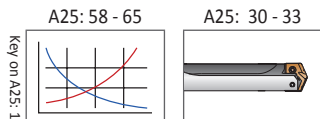

Sizes not shown are available upon request. When ordering, please follow the example below:	
Imperial:	0.5180", Steel, 0 series = use Part No. TAP0-13.16
Metric:	13.16 mm, Steel, 0 series = use Part No. TAP0-13.16

A
DRILLING
B
BORING
C
REAMING
D
BURNISHING
E
THREADING
X
SPECIALS

T-A Pro HSS Drill Inserts

1 Series | Diameter Range: 0.6947" - 0.9596" (17.65 mm - 24.37 mm)

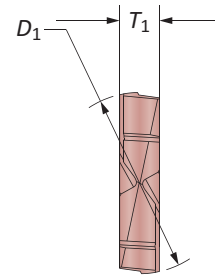
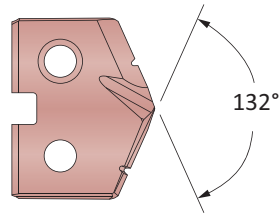
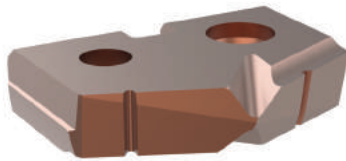

Series	Fractional Equivalent	Insert			Part No.
		D ₁ inch	D ₁ mm	T ₁	
1-C		0.8110	20.60	5/32	TAX1-20.60
1-C	13/16	0.8126	20.64	5/32	TAX1-20.64
1-C		0.8150	20.70	5/32	TAX1-20.70
1-C		0.8189	20.80	5/32	TAX1-20.80
1-C		0.8228	20.90	5/32	TAX1-20.90
1-C		0.8268	21.00	5/32	TAX1-21.00
1-C		0.8307	21.10	5/32	TAX1-21.10
1-C		0.8346	21.20	5/32	TAX1-21.20
1-C		0.8386	21.30	5/32	TAX1-21.30
1-C		0.8425	21.40	5/32	TAX1-21.40
1-C	27/32	0.8437	21.43	5/32	TAX1-21.43
1-C		0.8465	21.50	5/32	TAX1-21.50
1-C		0.8504	21.60	5/32	TAX1-21.60
1-C		0.8543	21.70	5/32	TAX1-21.70
1-C		0.8583	21.80	5/32	TAX1-21.80
1-C	55/64	0.8594	21.83	5/32	TAX1-21.83
1-C		0.8622	21.90	5/32	TAX1-21.90
1-C		0.8661	22.00	5/32	TAX1-22.00
1-C		0.8701	22.10	5/32	TAX1-22.10
1-C		0.8740	22.20	5/32	TAX1-22.20
1-C	7/8	0.8752	22.23	5/32	TAX1-22.23
1-C		0.8780	22.30	5/32	TAX1-22.30
1-C		0.8819	22.40	5/32	TAX1-22.40
1-C		0.8858	22.50	5/32	TAX1-22.50
1-C	57/64	0.8906	22.62	5/32	TAX1-22.62
1-C		0.8937	22.70	5/32	TAX1-22.70
1-C		0.8976	22.80	5/32	TAX1-22.80

Inserts sold in multiples of 2

Sub Series Holders (A, B, C, D)

Sub series holders are recommended when running carbide inserts toward the upper end of the series drill range, as well as in tougher applications requiring more insert support and holder strength. **NOTE:** Only specified sub series inserts should be used with equivalent or smaller sub series holders.



A Series Insert +
A Series Holder



C Series Insert +
A Series Holder



C Series Insert +
C Series Holder



A Series Insert +
C Series Holder

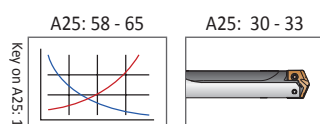



Sizes not shown are available upon request.
When ordering, please follow the example below:

Imperial:	0.5180", Steel, 0 series = use Part No. TAP0-13.16
Metric:	13.16 mm, Steel, 0 series = use Part No. TAP0-13.16

T-A Pro HSS Drill Inserts

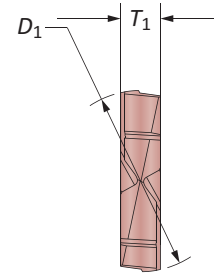
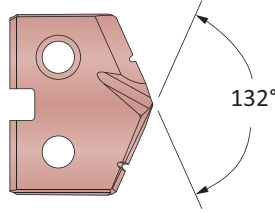
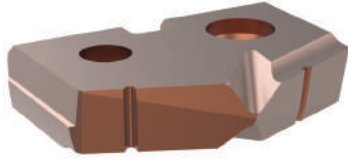
1 Series | Diameter Range: 0.6947" - 0.9596" (17.65 mm - 24.37 mm)



Series	Fractional Equivalent	Insert			Part No.
		D ₁ inch	D ₁ mm	T ₁	
1-D		0.9016	22.90	5/32	 X TAX1-22.90
1-D		0.9055	23.00	5/32	TAX1-23.00
1-D	29/32	0.9063	23.02	5/32	TAX1-23.02
1-D		0.9094	23.10	5/32	TAX1-23.10
1-D		0.9134	23.20	5/32	TAX1-23.20
1-D		0.9173	23.30	5/32	TAX1-23.30
1-D	59/64	0.9220	23.42	5/32	TAX1-23.42
1-D		0.9252	23.50	5/32	TAX1-23.50
1-D		0.9291	23.60	5/32	TAX1-23.60
1-D		0.9331	23.70	5/32	TAX1-23.70
1-D	15/16	0.9374	23.81	5/32	TAX1-23.81
1-D		0.9409	23.90	5/32	TAX1-23.90
1-D		0.9449	24.00	5/32	TAX1-24.00
1-D		0.9488	24.10	5/32	TAX1-24.10
1-D		0.9528	24.20	5/32	TAX1-24.20
1-D		0.9567	24.30	5/32	TAX1-24.30

Inserts sold in multiples of 2

Sub Series Holders (A, B, C, D)

Sub series holders are recommended when running carbide inserts toward the upper end of the series drill range, as well as in tougher applications requiring more insert support and holder strength. **NOTE:** Only specified sub series inserts should be used with equivalent or smaller sub series holders.



A Series Insert +
A Series Holder



C Series Insert +
A Series Holder



C Series Insert +
C Series Holder



A Series Insert +
C Series Holder

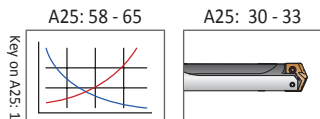

Sizes not shown are available upon request. When ordering, please follow the example below:	
Imperial:	0.5180", Steel, 0 series = use Part No. TAP0-13.16
Metric:	13.16 mm, Steel, 0 series = use Part No. TAP0-13.16



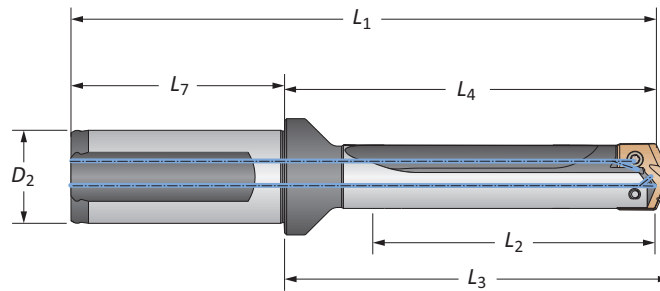

T-A Pro Drill Holders

1 Series Imperial | Diameter Range: 0.6947" - 0.9596"



		Body				Shank				
Length	Sub Series	L ₂	L ₄	L ₃	L ₁	L ₇	D ₂	Flat	Part No	
STUB	A	0.825	2.224	2.364	4.504	2.280	1.00	Yes	HTA1A01-100F	
STUB	A	0.825	2.224	2.364	4.504	2.280	1.00	No	HTA1A01-100C	
STUB	B	0.825	2.224	2.364	4.504	2.280	1.00	Yes	HTA1B01-100F	
STUB	B	0.825	2.224	2.364	4.504	2.280	1.00	No	HTA1B01-100C	
STUB	C	0.825	2.224	2.364	4.504	2.280	1.00	Yes	HTA1C01-100F	
STUB	C	0.825	2.224	2.364	4.504	2.280	1.00	No	HTA1C01-100C	
STUB	D	0.825	2.224	2.364	4.504	2.280	1.00	Yes	HTA1D01-100F	
STUB	D	0.825	2.224	2.364	4.504	2.280	1.00	No	HTA1D01-100C	
3xD	A	2.475	3.973	4.113	6.253	2.280	1.00	Yes	HTA1A03-100F	
3xD	A	2.475	3.973	4.113	6.253	2.280	1.00	No	HTA1A03-100C	
3xD	B	2.475	3.973	4.113	6.253	2.280	1.00	Yes	HTA1B03-100F	
3xD	B	2.475	3.973	4.113	6.253	2.280	1.00	No	HTA1B03-100C	
3xD	C	2.475	3.973	4.113	6.253	2.280	1.00	Yes	HTA1C03-100F	
3xD	C	2.475	3.973	4.113	6.253	2.280	1.00	No	HTA1C03-100C	
3xD	D	2.475	3.973	4.113	6.253	2.280	1.00	Yes	HTA1D03-100F	
3xD	D	2.475	3.973	4.113	6.253	2.280	1.00	No	HTA1D03-100C	
5xD	A	4.125	5.623	5.763	7.903	2.280	1.00	Yes	HTA1A05-100F	
5xD	A	4.125	5.623	5.763	7.903	2.280	1.00	No	HTA1A05-100C	
5xD	B	4.125	5.623	5.763	7.903	2.280	1.00	Yes	HTA1B05-100F	
5xD	B	4.125	5.623	5.763	7.903	2.280	1.00	No	HTA1B05-100C	
5xD	C	4.125	5.623	5.763	7.903	2.280	1.00	Yes	HTA1C05-100F	
5xD	C	4.125	5.623	5.763	7.903	2.280	1.00	No	HTA1C05-100C	
5xD	D	4.125	5.623	5.763	7.903	2.280	1.00	Yes	HTA1D05-100F	
5xD	D	4.125	5.623	5.763	7.903	2.280	1.00	No	HTA1D05-100C	
7xD	A	5.775	7.273	7.413	9.553	2.280	1.00	Yes	HTA1A07-100F	
7xD	A	5.775	7.273	7.413	9.553	2.280	1.00	No	HTA1A07-100C	
7xD	B	5.775	7.273	7.413	9.553	2.280	1.00	Yes	HTA1B07-100F	
7xD	B	5.775	7.273	7.413	9.553	2.280	1.00	No	HTA1B07-100C	
7xD	C	5.775	7.273	7.413	9.553	2.280	1.00	Yes	HTA1C07-100F	
7xD	C	5.775	7.273	7.413	9.553	2.280	1.00	No	HTA1C07-100C	
7xD	D	5.775	7.273	7.413	9.553	2.280	1.00	Yes	HTA1D07-100F	
7xD	D	5.775	7.273	7.413	9.553	2.280	1.00	No	HTA1D07-100C	

Connection Accessories

	 Insert Screws	 Nylon Locking Screws	 Insert Driver	 Preset Torque Hand Driver	 Replacement Tips	Admissible Tightening Torque*
A/B	7375-IP9-1	7375N-IP9-1	8IP-9	8IP-9TL	8IP-9B	27.0 in-lbs (305 N-cm)
C/D	739-IP9-1	739N-IP9-1	8IP-9	8IP-9TL	8IP-9B	27.0 in-lbs (305 N-cm)

*Tightening torques are calculated with a friction coefficient of $\mu = 0.14$ and develop 90% of ultimate yield strength

WARNING Refer to Speed and Feed charts for recommended adjustments to speeds and feeds. Refer to page A25: 68 for deep hole drilling guidelines in this section of the catalog. Visit www.alliedmachine.com/DeepHoleGuidelines for the most up-to-date information and procedures. Factory technical assistance is available for your specific applications through our Application Engineering department. ext: 7611 | email: appeng@alliedmachine.com

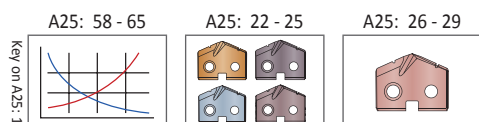

i = Imperial (in)
m = Metric (mm)

Screws sold in multiples of 10

T-A Pro Drill Holders

1 Series Imperial | Diameter Range: 0.6947 - 0.9596"

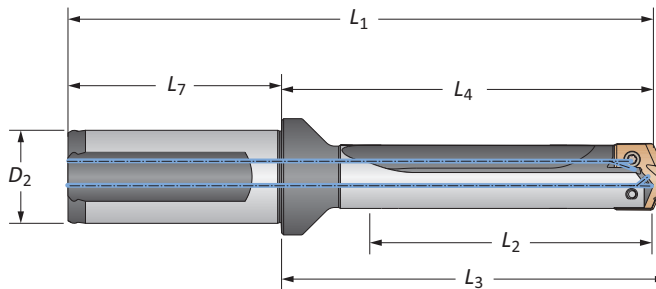

Length	Sub Series	Body				Shank			Flat	Part No
		L ₂	L ₄	L ₃	L ₁	L ₇	D ₂			
10xD	A	8.250	9.748	9.888	12.028	2.280	1.00	Yes	HTA1A10-100F	
10xD	A	8.250	9.748	9.888	12.028	2.280	1.00	No	HTA1A10-100C	
10xD	B	8.250	9.748	9.888	12.028	2.280	1.00	Yes	HTA1B10-100F	
10xD	B	8.250	9.748	9.888	12.028	2.280	1.00	No	HTA1B10-100C	
10xD	C	8.250	9.748	9.888	12.028	2.280	1.00	Yes	HTA1C10-100F	
10xD	C	8.250	9.748	9.888	12.028	2.280	1.00	No	HTA1C10-100C	
10xD	D	8.250	9.748	9.888	12.028	2.280	1.00	Yes	HTA1D10-100F	
10xD	D	8.250	9.748	9.888	12.028	2.280	1.00	No	HTA1D10-100C	
12xD	A	9.900	11.398	11.538	13.678	2.280	1.00	Yes	HTA1A12-100F	
12xD	A	9.900	11.398	11.538	13.678	2.280	1.00	No	HTA1A12-100C	
12xD	B	9.900	11.398	11.538	13.678	2.280	1.00	Yes	HTA1B12-100F	
12xD	B	9.900	11.398	11.538	13.678	2.280	1.00	No	HTA1B12-100C	
12xD	C	9.900	11.398	11.538	13.678	2.280	1.00	Yes	HTA1C12-100F	
12xD	C	9.900	11.398	11.538	13.678	2.280	1.00	No	HTA1C12-100C	
12xD	D	9.900	11.398	11.538	13.678	2.280	1.00	Yes	HTA1D12-100F	
12xD	D	9.900	11.398	11.538	13.678	2.280	1.00	No	HTA1D12-100C	
15xD	A	12.375	13.873	14.013	16.153	2.280	1.00	Yes	HTA1A15-100F	
15xD	A	12.375	13.873	14.013	16.153	2.280	1.00	No	HTA1A15-100C	
15xD	B	12.375	13.873	14.013	16.153	2.280	1.00	Yes	HTA1B15-100F	
15xD	B	12.375	13.873	14.013	16.153	2.280	1.00	No	HTA1B15-100C	
15xD	C	12.375	13.873	14.013	16.153	2.280	1.00	Yes	HTA1C15-100F	
15xD	C	12.375	13.873	14.013	16.153	2.280	1.00	No	HTA1C15-100C	
15xD	D	12.375	13.873	14.013	16.153	2.280	1.00	Yes	HTA1D15-100F	
15xD	D	12.375	13.873	14.013	16.153	2.280	1.00	No	HTA1D15-100C	

Connection Accessories

	Insert Screws	Nylon Locking Screws	Insert Driver	Preset Torque Hand Driver	Replacement Tips	Admissible Tightening Torque*
A/B	7375-IP9-1	7375N-IP9-1	8IP-9	8IP-9TL	8IP-9B	27.0 in-lbs (305 N-cm)
C/D	739-IP9-1	739N-IP9-1	8IP-9	8IP-9TL	8IP-9B	27.0 in-lbs (305 N-cm)

*Tightening torques are calculated with a friction coefficient of $\mu = 0.14$ and develop 90% of ultimate yield strength

WARNING Refer to Speed and Feed charts for recommended adjustments to speeds and feeds. Refer to page A25: 68 for deep hole drilling guidelines in this section of the catalog. Visit www.alliedmachine.com/DeepHoleGuidelines for the most up-to-date information and procedures. Factory technical assistance is available for your specific applications through our Application Engineering department.
ext: 7611 | email: appeng@alliedmachine.com

A25: 58 - 65 A25: 22 - 25 A25: 26 - 29

ⓘ = Imperial (in)
Ⓜ = Metric (mm)

Screws sold in multiples of 10



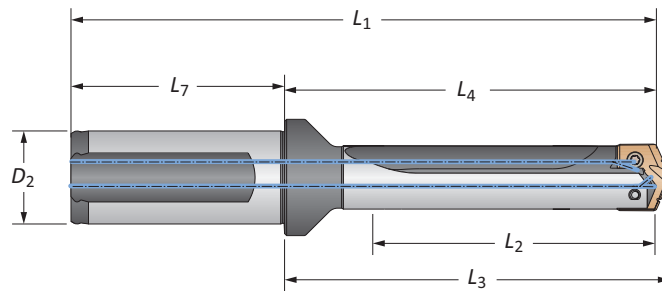

T-A Pro Drill Holders

1 Series Metric | Diameter Range: 17.65 mm - 24.37 mm

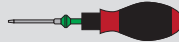

Body						Shank				Part No
Length	Sub Series	L ₂	L ₄	L ₃	L ₁	L ₇	D ₂	Flat		
STUB	A	21.0	56.5	60.0	114.4	56.0	25	Yes	HTA1A01-25FM	
STUB	A	21.0	56.5	60.0	114.4	56.0	25	No	HTA1A01-25CM	
STUB	B	21.0	56.5	60.0	114.4	56.0	25	Yes	HTA1B01-25FM	
STUB	B	21.0	56.5	60.0	114.4	56.0	25	No	HTA1B01-25CM	
STUB	C	21.0	56.5	60.0	114.4	56.0	25	Yes	HTA1C01-25FM	
STUB	C	21.0	56.5	60.0	114.4	56.0	25	No	HTA1C01-25CM	
STUB	D	21.0	56.5	60.0	114.4	56.0	25	Yes	HTA1D01-25FM	
STUB	D	21.0	56.5	60.0	114.4	56.0	25	No	HTA1D01-25CM	
3xD	A	62.9	100.9	104.5	158.8	56.0	25	Yes	HTA1A03-25FM	
3xD	A	62.9	100.9	104.5	158.8	56.0	25	No	HTA1A03-25CM	
3xD	B	62.9	100.9	104.5	158.8	56.0	25	Yes	HTA1B03-25FM	
3xD	B	62.9	100.9	104.5	158.8	56.0	25	No	HTA1B03-25CM	
3xD	C	62.9	100.9	104.5	158.8	56.0	25	Yes	HTA1C03-25FM	
3xD	C	62.9	100.9	104.5	158.8	56.0	25	No	HTA1C03-25CM	
3xD	D	62.9	100.9	104.5	158.8	56.0	25	Yes	HTA1D03-25FM	
3xD	D	62.9	100.9	104.5	158.8	56.0	25	No	HTA1D03-25CM	
5xD	A	104.8	142.8	146.4	200.7	56.0	25	Yes	HTA1A05-25FM	
5xD	A	104.8	142.8	146.4	200.7	56.0	25	No	HTA1A05-25CM	
5xD	B	104.8	142.8	146.4	200.7	56.0	25	Yes	HTA1B05-25FM	
5xD	B	104.8	142.8	146.4	200.7	56.0	25	No	HTA1B05-25CM	
5xD	C	104.8	142.8	146.4	200.7	56.0	25	Yes	HTA1C05-25FM	
5xD	C	104.8	142.8	146.4	200.7	56.0	25	No	HTA1C05-25CM	
5xD	D	104.8	142.8	146.4	200.7	56.0	25	Yes	HTA1D05-25FM	
5xD	D	104.8	142.8	146.4	200.7	56.0	25	No	HTA1D05-25CM	
7xD	A	146.7	184.7	188.3	242.7	56.0	25	Yes	HTA1A07-25FM	
7xD	A	146.7	184.7	188.3	242.7	56.0	25	No	HTA1A07-25CM	
7xD	B	146.7	184.7	188.3	242.7	56.0	25	Yes	HTA1B07-25FM	
7xD	B	146.7	184.7	188.3	242.7	56.0	25	No	HTA1B07-25CM	
7xD	C	146.7	184.7	188.3	242.7	56.0	25	Yes	HTA1C07-25FM	
7xD	C	146.7	184.7	188.3	242.7	56.0	25	No	HTA1C07-25CM	
7xD	D	146.7	184.7	188.3	242.7	56.0	25	Yes	HTA1D07-25FM	
7xD	D	146.7	184.7	188.3	242.7	56.0	25	No	HTA1D07-25CM	

Connection Accessories

	 Insert Screws	 Nylon Locking Screws	 Insert Driver	 Preset Torque Hand Driver	 Replacement Tips	Admissible Tightening Torque*
A/B	7375-IP9-1	7375N-IP9-1	8IP-9	8IP-9TL	8IP-9B	27.0 in-lbs (305 N-cm)
C/D	739-IP9-1	739N-IP9-1	8IP-9	8IP-9TL	8IP-9B	27.0 in-lbs (305 N-cm)

*Tightening torques are calculated with a friction coefficient of $\mu = 0.14$ and develop 90% of ultimate yield strength

⚠ WARNING Refer to Speed and Feed charts for recommended adjustments to speeds and feeds. Refer to page A25: 68 for deep hole drilling guidelines in this section of the catalog. Visit www.alliedmachine.com/DeepHoleGuidelines for the most up-to-date information and procedures. Factory technical assistance is available for your specific applications through our Application Engineering department.
ext: 7611 | email: appeng@alliedmachine.com

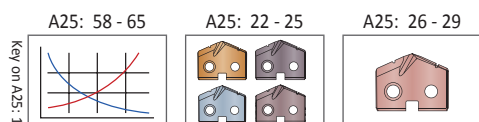

i = Imperial (in)
m = Metric (mm)

Screws sold in multiples of 10

T-A Pro Drill Holders

1 Series Metric | Diameter Range: 17.65 mm - 24.37 mm

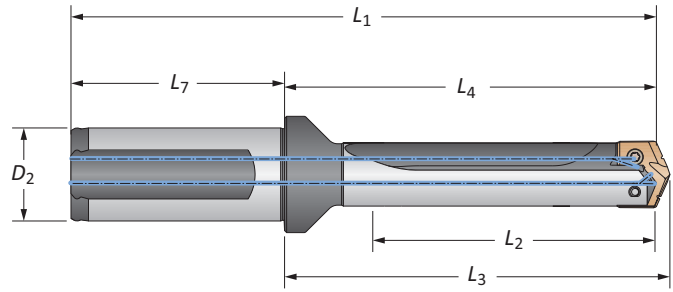

		Body				Shank				Part No	
Length	Sub Series	L ₂	L ₄	L ₃	L ₁	L ₇	D ₂	Flat			
Ⓜ	10xD	A	209.6	247.6	251.2	305.5	56.0	25	Yes	⚠ HTA1A10-25FM	
	10xD	A	209.6	247.6	251.2	305.5	56.0	25	No	⚠ HTA1A10-25CM	
	10xD	B	209.6	247.6	251.2	305.5	56.0	25	Yes	⚠ HTA1B10-25FM	
	10xD	B	209.6	247.6	251.2	305.5	56.0	25	No	⚠ HTA1B10-25CM	
	10xD	C	209.6	247.6	251.2	305.5	56.0	25	Yes	⚠ HTA1C10-25FM	
	10xD	C	209.6	247.6	251.2	305.5	56.0	25	No	⚠ HTA1C10-25CM	
	10xD	D	209.6	247.6	251.2	305.5	56.0	25	Yes	⚠ HTA1D10-25FM	
	10xD	D	209.6	247.6	251.2	305.5	56.0	25	No	⚠ HTA1D10-25CM	
	Ⓜ	12xD	A	251.5	289.5	293.1	347.4	56.0	25	Yes	⚠ HTA1A12-25FM
		12xD	A	251.5	289.5	293.1	347.4	56.0	25	No	⚠ HTA1A12-25CM
		12xD	B	251.5	289.5	293.1	347.4	56.0	25	Yes	⚠ HTA1B12-25FM
		12xD	B	251.5	289.5	293.1	347.4	56.0	25	No	⚠ HTA1B12-25CM
12xD		C	251.5	289.5	293.1	347.4	56.0	25	Yes	⚠ HTA1C12-25FM	
12xD		C	251.5	289.5	293.1	347.4	56.0	25	No	⚠ HTA1C12-25CM	
Ⓜ	12xD	D	251.5	289.5	293.1	347.4	56.0	25	Yes	⚠ HTA1D12-25FM	
	12xD	D	251.5	289.5	293.1	347.4	56.0	25	No	⚠ HTA1D12-25CM	
	Ⓜ	15xD	A	314.3	352.4	355.9	410.3	56.0	25	Yes	⚠ HTA1A15-25FM
		15xD	A	314.3	352.4	355.9	410.3	56.0	25	No	⚠ HTA1A15-25CM
		15xD	B	314.3	352.4	355.9	410.3	56.0	25	Yes	⚠ HTA1B15-25FM
		15xD	B	314.3	352.4	355.9	410.3	56.0	25	No	⚠ HTA1B15-25CM
15xD		C	314.3	352.4	355.9	410.3	56.0	25	Yes	⚠ HTA1C15-25FM	
15xD		C	314.3	352.4	355.9	410.3	56.0	25	No	⚠ HTA1C15-25CM	
Ⓜ	15xD	D	314.3	352.4	355.9	410.3	56.0	25	Yes	⚠ HTA1D15-25FM	
	15xD	D	314.3	352.4	355.9	410.3	56.0	25	No	⚠ HTA1D15-25CM	

Connection Accessories

	Insert Screws	Nylon Locking Screws	Insert Driver	Preset Torque Hand Driver	Replacement Tips	Admissible Tightening Torque*
A/B	7375-IP9-1	7375N-IP9-1	8IP-9	8IP-9TL	8IP-9B	27.0 in-lbs (305 N-cm)
C/D	739-IP9-1	739N-IP9-1	8IP-9	8IP-9TL	8IP-9B	27.0 in-lbs (305 N-cm)

*Tightening torques are calculated with a friction coefficient of $\mu = 0.14$ and develop 90% of ultimate yield strength

⚠ WARNING Refer to Speed and Feed charts for recommended adjustments to speeds and feeds. Refer to page A25: 68 for deep hole drilling guidelines in this section of the catalog. Visit www.alliedmachine.com/DeepHoleGuidelines for the most up-to-date information and procedures. Factory technical assistance is available for your specific applications through our Application Engineering department.
ext: 7611 | email: appeng@alliedmachine.com

A25: 58 - 65

A25: 22 - 25

A25: 26 - 29

Key on A25: 1

Ⓜ = Imperial (in)
Ⓜ = Metric (mm)





Screws sold in multiples of 10

A DRILLING
B BORING
C REAMING
D BURNISHING
E THREADING
F SPECIALS

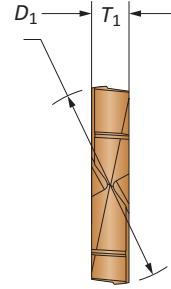
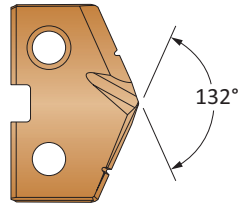
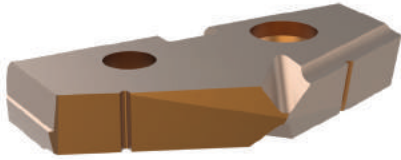
T-A Pro Carbide Drill Inserts

2 Series | Diameter Range: 0.9597" - 1.3797" (24.38 mm - 35.04 mm)



Insert								
Series	Fractional Equivalent	D_1 inch	D_1 mm	T_1	Part No. P	Part No. K	Part No. N	Part No. M
2-A		0.9606	24.40	3/16	TAP2-24.40	TAK2-24.40	TAN2-24.40	TAM2-24.40
2-A		0.9646	24.50	3/16	TAP2-24.50	TAK2-24.50	TAN2-24.50	TAM2-24.50
2-A	31/32	0.9689	24.61	3/16	TAP2-24.61	TAK2-24.61	TAN2-24.61	TAM2-24.61
2-A		0.9724	24.70	3/16	TAP2-24.70	TAK2-24.70	TAN2-24.70	TAM2-24.70
2-A		0.9764	24.80	3/16	TAP2-24.80	TAK2-24.80	TAN2-24.80	TAM2-24.80
2-A		0.9803	24.90	3/16	TAP2-24.90	TAK2-24.90	TAN2-24.90	TAM2-24.90
2-A	63/64	0.9843	25.00	3/16	TAP2-25.00	TAK2-25.00	TAN2-25.00	TAM2-25.00
2-A		0.9882	25.10	3/16	TAP2-25.10	TAK2-25.10	TAN2-25.10	TAM2-25.10
2-A		0.9921	25.20	3/16	TAP2-25.20	TAK2-25.20	TAN2-25.20	TAM2-25.20
2-A		0.9961	25.30	3/16	TAP2-25.30	TAK2-25.30	TAN2-25.30	TAM2-25.30

Inserts sold in multiples of 2

Sub Series Holders (A, B, C, D)

Sub series holders are recommended when running carbide inserts toward the upper end of the series drill range, as well as in tougher applications requiring more insert support and holder strength. **NOTE:** Only specified sub series inserts should be used with equivalent or smaller sub series holders.



A Series Insert +
A Series Holder



C Series Insert +
A Series Holder



C Series Insert +
C Series Holder



A Series Insert +
C Series Holder

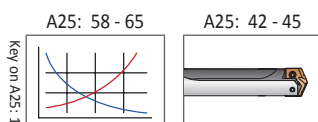

Sizes not shown are available upon request.
When ordering, please follow the example below:





Imperial:	0.5180", Steel, 0 series = use Part No. TAP0-13.16
Metric:	13.16 mm, Steel, 0 series = use Part No. TAP0-13.16

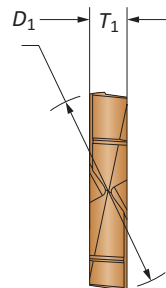
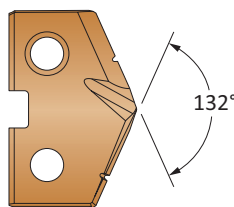
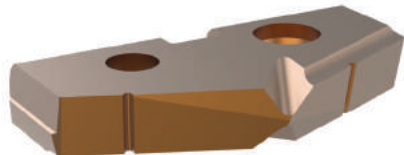

T-A Pro Carbide Drill Inserts

2 Series | Diameter Range: 0.9597" - 1.3797" (24.38 mm - 35.04 mm)



Series	Fractional Equivalent	Insert						
		D_1 inch	D_1 mm	T_1	Part No. P	Part No. K	Part No. N	Part No. M
2-B	1	1.0000	25.40	3/16	TAP2-25.40	TAK2-25.40	TAN2-25.40	TAM2-25.40
2-B		1.0039	25.50	3/16	TAP2-25.50	TAK2-25.50	TAN2-25.50	TAM2-25.50
2-B		1.0079	25.60	3/16	TAP2-25.60	TAK2-25.60	TAN2-25.60	TAM2-25.60
2-B		1.0118	25.70	3/16	TAP2-25.70	TAK2-25.70	TAN2-25.70	TAM2-25.70
2-B		1.0150	25.78	3/16	TAP2-25.78	TAK2-25.78	TAN2-25.78	TAM2-25.78
2-B		1.0197	25.90	3/16	TAP2-25.90	TAK2-25.90	TAN2-25.90	TAM2-25.90
2-B		1.0236	26.00	3/16	TAP2-26.00	TAK2-26.00	TAN2-26.00	TAM2-26.00
2-B		1.0276	26.10	3/16	TAP2-26.10	TAK2-26.10	TAN2-26.10	TAM2-26.10
2-B	1-1/32	1.0315	26.20	3/16	TAP2-26.20	TAK2-26.20	TAN2-26.20	TAM2-26.20
2-B		1.0354	26.30	3/16	TAP2-26.30	TAK2-26.30	TAN2-26.30	TAM2-26.30
2-B		1.0394	26.40	3/16	TAP2-26.40	TAK2-26.40	TAN2-26.40	TAM2-26.40
2-B		1.0433	26.50	3/16	TAP2-26.50	TAK2-26.50	TAN2-26.50	TAM2-26.50
2-B		1.0461	26.57	3/16	TAP2-26.57	TAK2-26.57	TAN2-26.57	TAM2-26.57
2-B	1-3/64	1.0469	26.59	3/16	TAP2-26.59	TAK2-26.59	TAN2-26.59	TAM2-26.59
2-B		1.0472	26.60	3/16	TAP2-26.60	TAK2-26.60	TAN2-26.60	TAM2-26.60
2-B		1.0512	26.70	3/16	TAP2-26.70	TAK2-26.70	TAN2-26.70	TAM2-26.70
2-B		1.0551	26.80	3/16	TAP2-26.80	TAK2-26.80	TAN2-26.80	TAM2-26.80
2-B		1.0591	26.90	3/16	TAP2-26.90	TAK2-26.90	TAN2-26.90	TAM2-26.90
2-B	1-1/16	1.0626	26.99	3/16	TAP2-26.99	TAK2-26.99	TAN2-26.99	TAM2-26.99
2-B		1.0630	27.00	3/16	TAP2-27.00	TAK2-27.00	TAN2-27.00	TAM2-27.00
2-B		1.0669	27.10	3/16	TAP2-27.10	TAK2-27.10	TAN2-27.10	TAM2-27.10
2-B		1.0709	27.20	3/16	TAP2-27.20	TAK2-27.20	TAN2-27.20	TAM2-27.20
2-B		1.0748	27.30	3/16	TAP2-27.30	TAK2-27.30	TAN2-27.30	TAM2-27.30
2-B		1.0787	27.40	3/16	TAP2-27.40	TAK2-27.40	TAN2-27.40	TAM2-27.40
2-B		1.0827	27.50	3/16	TAP2-27.50	TAK2-27.50	TAN2-27.50	TAM2-27.50
2-B		1.0866	27.60	3/16	TAP2-27.60	TAK2-27.60	TAN2-27.60	TAM2-27.60
2-B		1.0906	27.70	3/16	TAP2-27.70	TAK2-27.70	TAN2-27.70	TAM2-27.70
2-B	1-3/32	1.0937	27.78	3/16	TAP2-27.78	TAK2-27.78	TAN2-27.78	TAM2-27.78
2-B		1.0984	27.90	3/16	TAP2-27.90	TAK2-27.90	TAN2-27.90	TAM2-27.90
2-B		1.1024	28.00	3/16	TAP2-28.00	TAK2-28.00	TAN2-28.00	TAM2-28.00
2-B		1.1063	28.10	3/16	TAP2-28.10	TAK2-28.10	TAN2-28.10	TAM2-28.10
2-B	1-7/64	1.1091	28.17	3/16	TAP2-28.17	TAK2-28.17	TAN2-28.17	TAM2-28.17
2-B		1.1102	28.20	3/16	TAP2-28.20	TAK2-28.20	TAN2-28.20	TAM2-28.20
2-B		1.1142	28.30	3/16	TAP2-28.30	TAK2-28.30	TAN2-28.30	TAM2-28.30
2-B		1.1181	28.40	3/16	TAP2-28.40	TAK2-28.40	TAN2-28.40	TAM2-28.40

Inserts sold in multiples of 2

Sub Series Holders (A, B, C, D)

Sub series holders are recommended when running carbide inserts toward the upper end of the series drill range, as well as in tougher applications requiring more insert support and holder strength. **NOTE:** Only specified sub series inserts should be used with equivalent or smaller sub series holders.



A Series Insert + A Series Holder



C Series Insert + A Series Holder



C Series Insert + C Series Holder



A Series Insert + C Series Holder

A25: 58 - 65

A25: 42 - 45

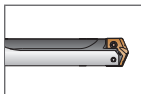
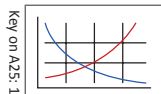

Sizes not shown are available upon request.





When ordering, please follow the example below:

Imperial:	0.5180", Steel, 0 series = use Part No. TAP0-13.16
Metric:	13.16 mm, Steel, 0 series = use Part No. TAP0-13.16

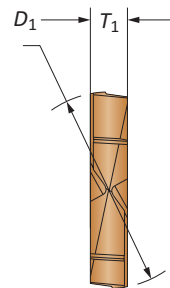
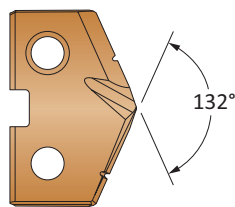
T-A Pro Carbide Drill Inserts

2 Series | Diameter Range: 0.9597" - 1.3797" (24.38 mm - 35.04 mm)



Insert								
Series	Fractional Equivalent	D ₁ inch	D ₁ mm	T ₁	Part No. P	Part No. K	Part No. N	Part No. M
2-C		1.1220	28.50	3/16	TAP2-28.50	TAK2-28.50	TAN2-28.50	TAM2-28.50
2-C	1-1/8	1.1252	28.58	3/16	TAP2-28.58	TAK2-28.58	TAN2-28.58	TAM2-28.58
2-C		1.1299	28.70	3/16	TAP2-28.70	TAK2-28.70	TAN2-28.70	TAM2-28.70
2-C		1.1339	28.80	3/16	TAP2-28.80	TAK2-28.80	TAN2-28.80	TAM2-28.80
2-C		1.1378	28.90	3/16	TAP2-28.90	TAK2-28.90	TAN2-28.90	TAM2-28.90
2-C		1.1417	29.00	3/16	TAP2-29.00	TAK2-29.00	TAN2-29.00	TAM2-29.00
2-C		1.1457	29.10	3/16	TAP2-29.10	TAK2-29.10	TAN2-29.10	TAM2-29.10
2-C		1.1496	29.20	3/16	TAP2-29.20	TAK2-29.20	TAN2-29.20	TAM2-29.20
2-C		1.1535	29.30	3/16	TAP2-29.30	TAK2-29.30	TAN2-29.30	TAM2-29.30
2-C	1-5/32	1.1563	29.37	3/16	TAP2-29.37	TAK2-29.37	TAN2-29.37	TAM2-29.37
2-C		1.1575	29.40	3/16	TAP2-29.40	TAK2-29.40	TAN2-29.40	TAM2-29.40
2-C		1.1614	29.50	3/16	TAP2-29.50	TAK2-29.50	TAN2-29.50	TAM2-29.50
2-C		1.1654	29.60	3/16	TAP2-29.60	TAK2-29.60	TAN2-29.60	TAM2-29.60
2-C		1.1693	29.70	3/16	TAP2-29.70	TAK2-29.70	TAN2-29.70	TAM2-29.70
2-C		1.1732	29.80	3/16	TAP2-29.80	TAK2-29.80	TAN2-29.80	TAM2-29.80
2-C		1.1772	29.90	3/16	TAP2-29.90	TAK2-29.90	TAN2-29.90	TAM2-29.90
2-C		1.1811	30.00	3/16	TAP2-30.00	TAK2-30.00	TAN2-30.00	TAM2-30.00
2-C		1.1850	30.10	3/16	TAP2-30.10	TAK2-30.10	TAN2-30.10	TAM2-30.10
2-C	1-3/16	1.1874	30.16	3/16	TAP2-30.16	TAK2-30.16	TAN2-30.16	TAM2-30.16
2-C		1.1890	30.20	3/16	TAP2-30.20	TAK2-30.20	TAN2-30.20	TAM2-30.20
2-C		1.1929	30.30	3/16	TAP2-30.30	TAK2-30.30	TAN2-30.30	TAM2-30.30
2-C		1.1969	30.40	3/16	TAP2-30.40	TAK2-30.40	TAN2-30.40	TAM2-30.40
2-C		1.2008	30.50	3/16	TAP2-30.50	TAK2-30.50	TAN2-30.50	TAM2-30.50
2-C		1.2047	30.60	3/16	TAP2-30.60	TAK2-30.60	TAN2-30.60	TAM2-30.60
2-C		1.2087	30.70	3/16	TAP2-30.70	TAK2-30.70	TAN2-30.70	TAM2-30.70
2-C		1.2126	30.80	3/16	TAP2-30.80	TAK2-30.80	TAN2-30.80	TAM2-30.80
2-C		1.2165	30.90	3/16	TAP2-30.90	TAK2-30.90	TAN2-30.90	TAM2-30.90
2-C	1-7/32	1.2189	30.96	3/16	TAP2-30.96	TAK2-30.96	TAN2-30.96	TAM2-30.96
2-C		1.2205	31.00	3/16	TAP2-31.00	TAK2-31.00	TAN2-31.00	TAM2-31.00
2-C		1.2244	31.10	3/16	TAP2-31.10	TAK2-31.10	TAN2-31.10	TAM2-31.10
2-C		1.2283	31.20	3/16	TAP2-31.20	TAK2-31.20	TAN2-31.20	TAM2-31.20
2-C		1.2323	31.30	3/16	TAP2-31.30	TAK2-31.30	TAN2-31.30	TAM2-31.30
2-C		1.2362	31.40	3/16	TAP2-31.40	TAK2-31.40	TAN2-31.40	TAM2-31.40
2-C		1.2402	31.50	3/16	TAP2-31.50	TAK2-31.50	TAN2-31.50	TAM2-31.50
2-C		1.2441	31.60	3/16	TAP2-31.60	TAK2-31.60	TAN2-31.60	TAM2-31.60

Inserts sold in multiples of 2

Sub Series Holders (A, B, C, D)

Sub series holders are recommended when running carbide inserts toward the upper end of the series drill range, as well as in tougher applications requiring more insert support and holder strength. **NOTE:** Only specified sub series inserts should be used with equivalent or smaller sub series holders.



A Series Insert +
A Series Holder



C Series Insert +
A Series Holder



C Series Insert +
C Series Holder



A Series Insert +
C Series Holder

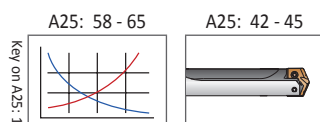

Sizes not shown are available upon request.
When ordering, please follow the example below:

Imperial:	0.5180", Steel, 0 series = use Part No. TAP0-13.16
Metric:	13.16 mm, Steel, 0 series = use Part No. TAP0-13.16



T-A Pro Carbide Drill Inserts

2 Series | Diameter Range: 0.9597" - 1.3797" (24.38 mm - 35.04 mm)

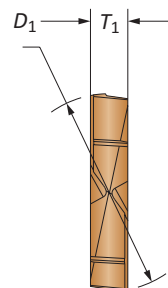
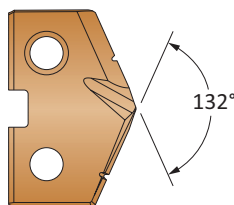
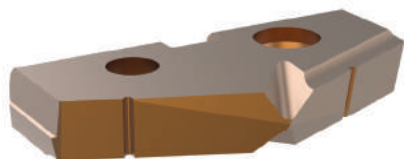

Insert								
Series	Fractional Equivalent	D ₁ inch	D ₁ mm	T ₁	Part No. P	Part No. K	Part No. N	Part No. M
2-D		1.2480	31.70	3/16	TAP2-31.70	TAK2-31.70	TAN2-31.70	TAM2-31.70
2-D	1-1/4	1.2500	31.75	3/16	TAP2-31.75	TAK2-31.75	TAN2-31.75	TAM2-31.75
2-D		1.2520	31.80	3/16	TAP2-31.80	TAK2-31.80	TAN2-31.80	TAM2-31.80
2-D		1.2559	31.90	3/16	TAP2-31.90	TAK2-31.90	TAN2-31.90	TAM2-31.90
2-D		1.2598	32.00	3/16	TAP2-32.00	TAK2-32.00	TAN2-32.00	TAM2-32.00
2-D		1.2638	32.10	3/16	TAP2-32.10	TAK2-32.10	TAN2-32.10	TAM2-32.10
2-D	1-17/64	1.2657	32.15	3/16	TAP2-32.15	TAK2-32.15	TAN2-32.15	TAM2-32.15
2-D		1.2677	32.20	3/16	TAP2-32.20	TAK2-32.20	TAN2-32.20	TAM2-32.20
2-D		1.2717	32.30	3/16	TAP2-32.30	TAK2-32.30	TAN2-32.30	TAM2-32.30
2-D		1.2756	32.40	3/16	TAP2-32.40	TAK2-32.40	TAN2-32.40	TAM2-32.40
2-D		1.2795	32.50	3/16	TAP2-32.50	TAK2-32.50	TAN2-32.50	TAM2-32.50
2-D	1-9/32	1.2815	32.55	3/16	TAP2-32.55	TAK2-32.55	TAN2-32.55	TAM2-32.55
2-D		1.2835	32.60	3/16	TAP2-32.60	TAK2-32.60	TAN2-32.60	TAM2-32.60
2-D		1.2874	32.70	3/16	TAP2-32.70	TAK2-32.70	TAN2-32.70	TAM2-32.70
2-D		1.2913	32.80	3/16	TAP2-32.80	TAK2-32.80	TAN2-32.80	TAM2-32.80
2-D		1.2953	32.90	3/16	TAP2-32.90	TAK2-32.90	TAN2-32.90	TAM2-32.90
2-D		1.2992	33.00	3/16	TAP2-33.00	TAK2-33.00	TAN2-33.00	TAM2-33.00
2-D		1.3031	33.10	3/16	TAP2-33.10	TAK2-33.10	TAN2-33.10	TAM2-33.10
2-D		1.3071	33.20	3/16	TAP2-33.20	TAK2-33.20	TAN2-33.20	TAM2-33.20
2-D		1.3110	33.30	3/16	TAP2-33.30	TAK2-33.30	TAN2-33.30	TAM2-33.30
2-D	1-5/16	1.3126	33.34	3/16	TAP2-33.34	TAK2-33.34	TAN2-33.34	TAM2-33.34
2-D		1.3150	33.40	3/16	TAP2-33.40	TAK2-33.40	TAN2-33.40	TAM2-33.40
2-D		1.3189	33.50	3/16	TAP2-33.50	TAK2-33.50	TAN2-33.50	TAM2-33.50
2-D		1.3228	33.60	3/16	TAP2-33.60	TAK2-33.60	TAN2-33.60	TAM2-33.60
2-D		1.3268	33.70	3/16	TAP2-33.70	TAK2-33.70	TAN2-33.70	TAM2-33.70
2-D		1.3307	33.80	3/16	TAP2-33.80	TAK2-33.80	TAN2-33.80	TAM2-33.80
2-D		1.3346	33.90	3/16	TAP2-33.90	TAK2-33.90	TAN2-33.90	TAM2-33.90
2-D		1.3386	34.00	3/16	TAP2-34.00	TAK2-34.00	TAN2-34.00	TAM2-34.00
2-D		1.3425	34.10	3/16	TAP2-34.10	TAK2-34.10	TAN2-34.10	TAM2-34.10
2-D	1-11/32	1.3437	34.13	3/16	TAP2-34.13	TAK2-34.13	TAN2-34.13	TAM2-34.13
2-D		1.3465	34.20	3/16	TAP2-34.20	TAK2-34.20	TAN2-34.20	TAM2-34.20
2-D		1.3504	34.30	3/16	TAP2-34.30	TAK2-34.30	TAN2-34.30	TAM2-34.30
2-D		1.3543	34.40	3/16	TAP2-34.40	TAK2-34.40	TAN2-34.40	TAM2-34.40
2-D		1.3583	34.50	3/16	TAP2-34.50	TAK2-34.50	TAN2-34.50	TAM2-34.50
2-D		1.3622	34.60	3/16	TAP2-34.60	TAK2-34.60	TAN2-34.60	TAM2-34.60
2-D		1.3661	34.70	3/16	TAP2-34.70	TAK2-34.70	TAN2-34.70	TAM2-34.70
2-D		1.3701	34.80	3/16	TAP2-34.80	TAK2-34.80	TAN2-34.80	TAM2-34.80
2-D		1.3740	34.90	3/16	TAP2-34.90	TAK2-34.90	TAN2-34.90	TAM2-34.90
2-D	1-3/8	1.3752	34.93	3/16	TAP2-34.93	TAK2-34.93	TAN2-34.93	TAM2-34.93
2-D		1.3780	35.00	3/16	TAP2-35.00	TAK2-35.00	TAN2-35.00	TAM2-35.00

Inserts sold in multiples of 2

Sub Series Holders (A, B, C, D)
 Sub series holders are recommended when running carbide inserts toward the upper end of the series drill range, as well as in tougher applications requiring more insert support and holder strength. **NOTE:** Only specified sub series inserts should be used with equivalent or smaller sub series holders.

A Series Insert +
A Series Holder

C Series Insert +
A Series Holder

C Series Insert +
C Series Holder

A Series Insert +
C Series Holder

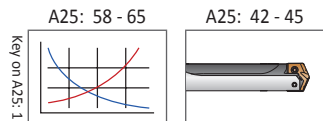

Sizes not shown are available upon request.
 When ordering, please follow the example below:

Imperial:	0.5180", Steel, 0 series = use Part No. TAP0-13.16
Metric:	13.16 mm, Steel, 0 series = use Part No. TAP0-13.16

A DRILLING
B BORING
C REAMING
D BURNISHING
E THREADING
X SPECIALS

T-A Pro HSS Drill Inserts

2 Series | Diameter Range: 0.9597" - 1.3797" (24.38 mm - 35.04 mm)

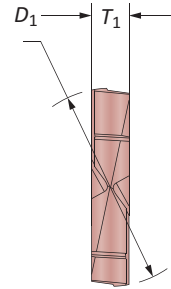
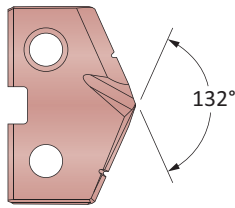
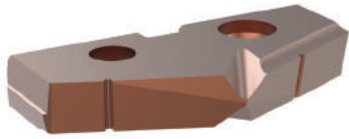

Series	Fractional Equivalent	Insert			Part No.
		D_1 inch	D_1 mm	T_1	
2-A		0.9606	24.40	3/16	X TAX2-24.40
2-A		0.9646	24.50	3/16	TAX2-24.50
2-A	31/32	0.9689	24.61	3/16	TAX2-24.61
2-A		0.9724	24.70	3/16	TAX2-24.70
2-A		0.9764	24.80	3/16	TAX2-24.80
2-A		0.9803	24.90	3/16	TAX2-24.90
2-A	63/64	0.9843	25.00	3/16	TAX2-25.00
2-A		0.9882	25.10	3/16	TAX2-25.10
2-A		0.9921	25.20	3/16	TAX2-25.20
2-A		0.9961	25.30	3/16	TAX2-25.30

Inserts sold in multiples of 2

Sub Series Holders (A, B, C, D)

Sub series holders are recommended when running carbide inserts toward the upper end of the series drill range, as well as in tougher applications requiring more insert support and holder strength. **NOTE:** Only specified sub series inserts should be used with equivalent or smaller sub series holders.

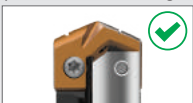

A Series Insert +
A Series Holder



C Series Insert +
A Series Holder



C Series Insert +
C Series Holder



A Series Insert +
C Series Holder

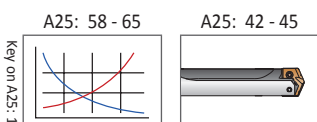

Sizes not shown are available upon request.
When ordering, please follow the example below:

Imperial:	0.5180", Steel, 0 series = use Part No. TAP0-13.16
Metric:	13.16 mm, Steel, 0 series = use Part No. TAP0-13.16



T-A Pro HSS Drill Inserts

2 Series | Diameter Range: 0.9597" - 1.3797" (24.38 mm - 35.04 mm)

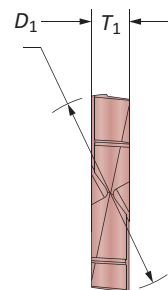
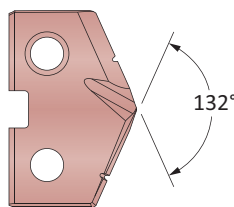
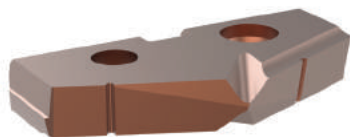

Series	Fractional Equivalent	Insert			Part No.
		D ₁ inch	D ₁ mm	T ₁	
2-B	1	1.0000	25.40	3/16	TAX2-25.40
2-B		1.0039	25.50	3/16	TAX2-25.50
2-B		1.0079	25.60	3/16	TAX2-25.60
2-B		1.0118	25.70	3/16	TAX2-25.70
2-B		1.0150	25.78	3/16	TAX2-25.78
2-B		1.0197	25.90	3/16	TAX2-25.90
2-B		1.0236	26.00	3/16	TAX2-26.00
2-B		1.0276	26.10	3/16	TAX2-26.10
2-B	1-1/32	1.0315	26.20	3/16	TAX2-26.20
2-B		1.0354	26.30	3/16	TAX2-26.30
2-B		1.0394	26.40	3/16	TAX2-26.40
2-B		1.0433	26.50	3/16	TAX2-26.50
2-B		1.0461	26.57	3/16	TAX2-26.57
2-B	1-3/64	1.0469	26.59	3/16	TAX2-26.59
2-B		1.0472	26.60	3/16	TAX2-26.60
2-B		1.0512	26.70	3/16	TAX2-26.70
2-B		1.0551	26.80	3/16	TAX2-26.80
2-B		1.0591	26.90	3/16	TAX2-26.90
2-B	1-1/16	1.0626	26.99	3/16	TAX2-26.99
2-B		1.0630	27.00	3/16	TAX2-27.00
2-B		1.0669	27.10	3/16	TAX2-27.10
2-B		1.0709	27.20	3/16	TAX2-27.20
2-B		1.0748	27.30	3/16	TAX2-27.30
2-B		1.0787	27.40	3/16	TAX2-27.40
2-B		1.0827	27.50	3/16	TAX2-27.50
2-B		1.0866	27.60	3/16	TAX2-27.60
2-B		1.0906	27.70	3/16	TAX2-27.70
2-B	1-3/32	1.0937	27.78	3/16	TAX2-27.78
2-B		1.0984	27.90	3/16	TAX2-27.90
2-B		1.1024	28.00	3/16	TAX2-28.00
2-B		1.1063	28.10	3/16	TAX2-28.10
2-B	1-7/64	1.1091	28.17	3/16	TAX2-28.17
2-B		1.1102	28.20	3/16	TAX2-28.20
2-B		1.1142	28.30	3/16	TAX2-28.30
2-B		1.1181	28.40	3/16	TAX2-28.40

Inserts sold in multiples of 2

Sub Series Holders (A, B, C, D)

Sub series holders are recommended when running carbide inserts toward the upper end of the series drill range, as well as in tougher applications requiring more insert support and holder strength. **NOTE:** Only specified sub series inserts should be used with equivalent or smaller sub series holders.



A Series Insert + A Series Holder



C Series Insert + A Series Holder



C Series Insert + C Series Holder



A Series Insert + C Series Holder

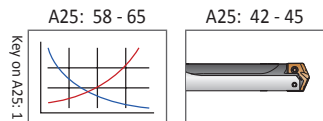



Sizes not shown are available upon request.
When ordering, please follow the example below:

Imperial:	0.5180", Steel, 0 series = use Part No. TAP0-13.16
Metric:	13.16 mm, Steel, 0 series = use Part No. TAP0-13.16

T-A Pro HSS Drill Inserts

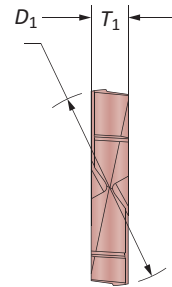
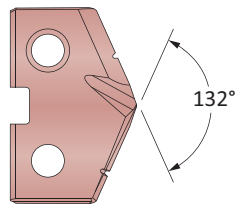
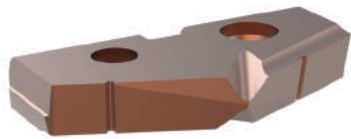
2 Series | Diameter Range: 0.9597" - 1.3797" (24.38 mm - 35.04 mm)



Insert					
Series	Fractional Equivalent	D ₁ inch	D ₁ mm	T ₁	Part No. X
2-C		1.1220	28.50	3/16	TAX2-28.50
2-C	1-1/8	1.1252	28.58	3/16	TAX2-28.58
2-C		1.1299	28.70	3/16	TAX2-28.70
2-C		1.1339	28.80	3/16	TAX2-28.80
2-C		1.1378	28.90	3/16	TAX2-28.90
2-C		1.1417	29.00	3/16	TAX2-29.00
2-C		1.1457	29.10	3/16	TAX2-29.10
2-C		1.1496	29.20	3/16	TAX2-29.20
2-C		1.1535	29.30	3/16	TAX2-29.30
2-C	1-5/32	1.1563	29.37	3/16	TAX2-29.37
2-C		1.1575	29.40	3/16	TAX2-29.40
2-C		1.1614	29.50	3/16	TAX2-29.50
2-C		1.1654	29.60	3/16	TAX2-29.60
2-C		1.1693	29.70	3/16	TAX2-29.70
2-C		1.1732	29.80	3/16	TAX2-29.80
2-C		1.1772	29.90	3/16	TAX2-29.90
2-C		1.1811	30.00	3/16	TAX2-30.00
2-C		1.1850	30.10	3/16	TAX2-30.10
2-C	1-3/16	1.1874	30.16	3/16	TAX2-30.16
2-C		1.1890	30.20	3/16	TAX2-30.20
2-C		1.1929	30.30	3/16	TAX2-30.30
2-C		1.1969	30.40	3/16	TAX2-30.40
2-C		1.2008	30.50	3/16	TAX2-30.50
2-C		1.2047	30.60	3/16	TAX2-30.60
2-C		1.2087	30.70	3/16	TAX2-30.70
2-C		1.2126	30.80	3/16	TAX2-30.80
2-C		1.2165	30.90	3/16	TAX2-30.90
2-C	1-7/32	1.2189	30.96	3/16	TAX2-30.96
2-C		1.2205	31.00	3/16	TAX2-31.00
2-C		1.2244	31.10	3/16	TAX2-31.10
2-C		1.2283	31.20	3/16	TAX2-31.20
2-C		1.2323	31.30	3/16	TAX2-31.30
2-C		1.2362	31.40	3/16	TAX2-31.40
2-C		1.2402	31.50	3/16	TAX2-31.50
2-C		1.2441	31.60	3/16	TAX2-31.60

Inserts sold in multiples of 2

Sub Series Holders (A, B, C, D)

Sub series holders are recommended when running carbide inserts toward the upper end of the series drill range, as well as in tougher applications requiring more insert support and holder strength. **NOTE:** Only specified sub series inserts should be used with equivalent or smaller sub series holders.



A Series Insert +
A Series Holder



C Series Insert +
A Series Holder



C Series Insert +
C Series Holder



A Series Insert +
C Series Holder

A25: 58 - 65

A25: 42 - 45

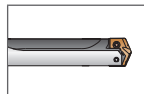
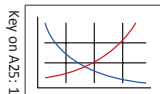

Sizes not shown are available upon request.
When ordering, please follow the example below:

Imperial:	0.5180", Steel, 0 series = use Part No. TAP0-13.16
Metric:	13.16 mm, Steel, 0 series = use Part No. TAP0-13.16

T-A Pro HSS Drill Inserts

2 Series | Diameter Range: 0.9597" - 1.3797" (24.38 mm - 35.04 mm)

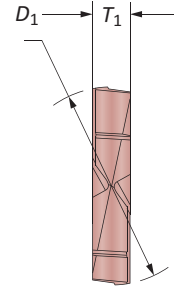
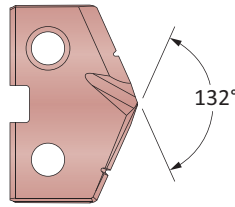
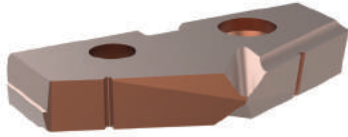

Series	Fractional Equivalent	Insert			Part No.
		D ₁ inch	D ₁ mm	T ₁	
2-D		1.2480	31.70	3/16	TAX2-31.70
2-D	1-1/4	1.2500	31.75	3/16	TAX2-31.75
2-D		1.2520	31.80	3/16	TAX2-31.80
2-D		1.2559	31.90	3/16	TAX2-31.90
2-D		1.2598	32.00	3/16	TAX2-32.00
2-D		1.2638	32.10	3/16	TAX2-32.10
2-D	1-17/64	1.2657	32.15	3/16	TAX2-32.15
2-D		1.2677	32.20	3/16	TAX2-32.20
2-D		1.2717	32.30	3/16	TAX2-32.30
2-D		1.2756	32.40	3/16	TAX2-32.40
2-D		1.2795	32.50	3/16	TAX2-32.50
2-D	1-9/32	1.2815	32.55	3/16	TAX2-32.55
2-D		1.2835	32.60	3/16	TAX2-32.60
2-D		1.2874	32.70	3/16	TAX2-32.70
2-D		1.2913	32.80	3/16	TAX2-32.80
2-D		1.2953	32.90	3/16	TAX2-32.90
2-D		1.2992	33.00	3/16	TAX2-33.00
2-D		1.3031	33.10	3/16	TAX2-33.10
2-D		1.3071	33.20	3/16	TAX2-33.20
2-D		1.3110	33.30	3/16	TAX2-33.30
2-D	1-5/16	1.3126	33.34	3/16	TAX2-33.34
2-D		1.3150	33.40	3/16	TAX2-33.40
2-D		1.3189	33.50	3/16	TAX2-33.50
2-D		1.3228	33.60	3/16	TAX2-33.60
2-D		1.3268	33.70	3/16	TAX2-33.70
2-D		1.3307	33.80	3/16	TAX2-33.80
2-D		1.3346	33.90	3/16	TAX2-33.90
2-D		1.3386	34.00	3/16	TAX2-34.00
2-D		1.3425	34.10	3/16	TAX2-34.10
2-D	1-11/32	1.3437	34.13	3/16	TAX2-34.13
2-D		1.3465	34.20	3/16	TAX2-34.20
2-D		1.3504	34.30	3/16	TAX2-34.30
2-D		1.3543	34.40	3/16	TAX2-34.40
2-D		1.3583	34.50	3/16	TAX2-34.50
2-D		1.3622	34.60	3/16	TAX2-34.60
2-D		1.3661	34.70	3/16	TAX2-34.70
2-D		1.3701	34.80	3/16	TAX2-34.80
2-D		1.3740	34.90	3/16	TAX2-34.90
2-D	1-3/8	1.3752	34.93	3/16	TAX2-34.93
2-D		1.3780	35.00	3/16	TAX2-35.00

Inserts sold in multiples of 2

Sub Series Holders (A, B, C, D)

Sub series holders are recommended when running carbide inserts toward the upper end of the series drill range, as well as in tougher applications requiring more insert support and holder strength. **NOTE:** Only specified sub series inserts should be used with equivalent or smaller sub series holders.



A Series Insert + A Series Holder



C Series Insert + A Series Holder



C Series Insert + C Series Holder



A Series Insert + C Series Holder

A25: 58 - 65

A25: 42 - 45

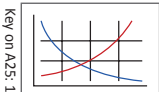

Sizes not shown are available upon request. When ordering, please follow the example below:

Imperial:	0.5180", Steel, 0 series = use Part No. TAP0-13.16
Metric:	13.16 mm, Steel, 0 series = use Part No. TAP0-13.16

A DRILLING
B BORING
C REAMING
D BURNISHING
E THREADING
X SPECIALS

T-A Pro Drill Holders

2 Series Imperial | Diameter Range: 0.9597" - 1.3797"

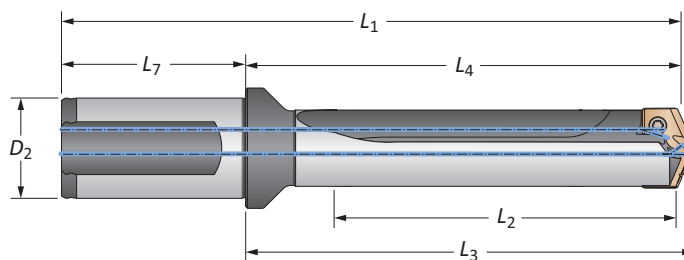

Body						Shank			Flat	Part No
Length	Sub Series	L ₂	L ₄	L ₃	L ₁	L ₇	D ₂			
STUB	A	1.171	2.954	3.094	5.234	2.280	1-1/4	Yes	HTA2A01-125F	
STUB	A	1.171	2.954	3.094	5.234	2.280	1-1/4	No	HTA2A01-125C	
STUB	B	1.171	2.954	3.094	5.234	2.280	1-1/4	Yes	HTA2B01-125F	
STUB	B	1.171	2.954	3.094	5.234	2.280	1-1/4	No	HTA2B01-125C	
STUB	C	1.171	2.954	3.094	5.234	2.280	1-1/4	Yes	HTA2C01-125F	
STUB	C	1.171	2.954	3.094	5.234	2.280	1-1/4	No	HTA2C01-125C	
STUB	D	1.171	2.954	3.094	5.234	2.280	1-1/4	Yes	HTA2D01-125F	
STUB	D	1.171	2.954	3.094	5.234	2.280	1-1/4	No	HTA2D01-125C	
3xD	A	3.513	5.411	5.551	7.691	2.280	1-1/4	Yes	HTA2A03-125F	
3xD	A	3.513	5.411	5.551	7.691	2.280	1-1/4	No	HTA2A03-125C	
3xD	B	3.513	5.411	5.551	7.691	2.280	1-1/4	Yes	HTA2B03-125F	
3xD	B	3.513	5.411	5.551	7.691	2.280	1-1/4	No	HTA2B03-125C	
3xD	C	3.513	5.411	5.551	7.691	2.280	1-1/4	Yes	HTA2C03-125F	
3xD	C	3.513	5.411	5.551	7.691	2.280	1-1/4	No	HTA2C03-125C	
3xD	D	3.513	5.411	5.551	7.691	2.280	1-1/4	Yes	HTA2D03-125F	
3xD	D	3.513	5.411	5.551	7.691	2.280	1-1/4	No	HTA2D03-125C	
5xD	A	5.855	7.753	7.893	10.033	2.280	1-1/4	Yes	HTA2A05-125F	
5xD	A	5.855	7.753	7.893	10.033	2.280	1-1/4	No	HTA2A05-125C	
5xD	B	5.855	7.753	7.893	10.033	2.280	1-1/4	Yes	HTA2B05-125F	
5xD	B	5.855	7.753	7.893	10.033	2.280	1-1/4	No	HTA2B05-125C	
5xD	C	5.855	7.753	7.893	10.033	2.280	1-1/4	Yes	HTA2C05-125F	
5xD	C	5.855	7.753	7.893	10.033	2.280	1-1/4	No	HTA2C05-125C	
5xD	D	5.855	7.753	7.893	10.033	2.280	1-1/4	Yes	HTA2D05-125F	
5xD	D	5.855	7.753	7.893	10.033	2.280	1-1/4	No	HTA2D05-125C	
7xD	A	8.197	10.095	10.235	12.375	2.280	1-1/4	Yes	HTA2A07-125F	
7xD	A	8.197	10.095	10.235	12.375	2.280	1-1/4	No	HTA2A07-125C	
7xD	B	8.197	10.095	10.235	12.375	2.280	1-1/4	Yes	HTA2B07-125F	
7xD	B	8.197	10.095	10.235	12.375	2.280	1-1/4	No	HTA2B07-125C	
7xD	C	8.197	10.095	10.235	12.375	2.280	1-1/4	Yes	HTA2C07-125F	
7xD	C	8.197	10.095	10.235	12.375	2.280	1-1/4	No	HTA2C07-125C	
7xD	D	8.197	10.095	10.235	12.375	2.280	1-1/4	Yes	HTA2D07-125F	
7xD	D	8.197	10.095	10.235	12.375	2.280	1-1/4	No	HTA2D07-125C	

Connection Accessories

Insert Screws	Nylon Locking Screws	Insert Driver	Preset Torque Hand Driver	Replacement Tips	Admissible Tightening Torque*
7495-IP15-1	7495N-IP15-1	8IP-15	8IP-15TL	8IP-15B	61.0 in-lbs (690 N-cm)

*Tightening torques are calculated with a friction coefficient of $\mu = 0.14$ and develop 90% of ultimate yield strength

⚠ WARNING Refer to Speed and Feed charts for recommended adjustments to speeds and feeds. Refer to page A25: 68 for deep hole drilling guidelines in this section of the catalog. Visit www.alliedmachine.com/DeepHoleGuidelines for the most up-to-date information and procedures. Factory technical assistance is available for your specific applications through our Application Engineering department.
 ext: 7611 | email: appeng@alliedmachine.com

A25: 58 - 65

A25: 34 - 37

A25: 38 - 41

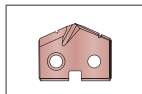
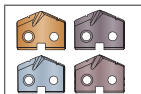
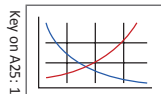

i = Imperial (in)
m = Metric (mm)

Screws sold in multiples of 10

T-A Pro Drill Holders

2 Series Imperial | Diameter Range: 0.9597" - 1.3797"

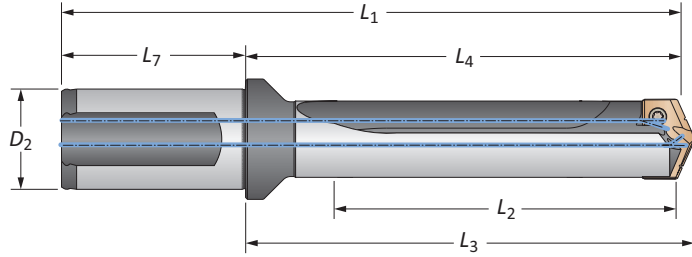

Length	Sub Series	Body				Shank			Flat	Part No
		L ₂	L ₄	L ₃	L ₁	L ₇	D ₂			
10xD	A	11.710	13.608	13.748	15.888	2.280	1-1/4	Yes	HTA2A10-125F	
10xD	A	11.710	13.608	13.748	15.888	2.280	1-1/4	No	HTA2A10-125C	
10xD	B	11.710	13.608	13.748	15.888	2.280	1-1/4	Yes	HTA2B10-125F	
10xD	B	11.710	13.608	13.748	15.888	2.280	1-1/4	No	HTA2B10-125C	
10xD	C	11.710	13.608	13.748	15.888	2.280	1-1/4	Yes	HTA2C10-125F	
10xD	C	11.710	13.608	13.748	15.888	2.280	1-1/4	No	HTA2C10-125C	
10xD	D	11.710	13.608	13.748	15.888	2.280	1-1/4	Yes	HTA2D10-125F	
10xD	D	11.710	13.608	13.748	15.888	2.280	1-1/4	No	HTA2D10-125C	
12xD	A	14.052	15.950	16.090	18.230	2.280	1-1/4	Yes	HTA2A12-125F	
12xD	A	14.052	15.950	16.090	18.230	2.280	1-1/4	No	HTA2A12-125C	
12xD	B	14.052	15.950	16.090	18.230	2.280	1-1/4	Yes	HTA2B12-125F	
12xD	B	14.052	15.950	16.090	18.230	2.280	1-1/4	No	HTA2B12-125C	
12xD	C	14.052	15.950	16.090	18.230	2.280	1-1/4	Yes	HTA2C12-125F	
12xD	C	14.052	15.950	16.090	18.230	2.280	1-1/4	No	HTA2C12-125C	
12xD	D	14.052	15.950	16.090	18.230	2.280	1-1/4	Yes	HTA2D12-125F	
12xD	D	14.052	15.950	16.090	18.230	2.280	1-1/4	No	HTA2D12-125C	
15xD	A	17.565	19.463	19.603	21.743	2.280	1-1/4	Yes	HTA2A15-125F	
15xD	A	17.565	19.463	19.603	21.743	2.280	1-1/4	No	HTA2A15-125C	
15xD	B	17.565	19.463	19.603	21.743	2.280	1-1/4	Yes	HTA2B15-125F	
15xD	B	17.565	19.463	19.603	21.743	2.280	1-1/4	No	HTA2B15-125C	
15xD	C	17.565	19.463	19.603	21.743	2.280	1-1/4	Yes	HTA2C15-125F	
15xD	C	17.565	19.463	19.603	21.743	2.280	1-1/4	No	HTA2C15-125C	
15xD	D	17.565	19.463	19.603	21.743	2.280	1-1/4	Yes	HTA2D15-125F	
15xD	D	17.565	19.463	19.603	21.743	2.280	1-1/4	No	HTA2D15-125C	

Connection Accessories

					Admissible Tightening Torque*
7495-IP15-1	7495N-IP15-1	8IP-15	8IP-15TL	8IP-15B	61.0 in-lbs (690 N-cm)

*Tightening torques are calculated with a friction coefficient of $\mu = 0.14$ and develop 90% of ultimate yield strength

WARNING Refer to Speed and Feed charts for recommended adjustments to speeds and feeds. Refer to page A25: 68 for deep hole drilling guidelines in this section of the catalog. Visit www.alliedmachine.com/DeepHoleGuidelines for the most up-to-date information and procedures. Factory technical assistance is available for your specific applications through our Application Engineering department. ext: 7611 | email: appeng@alliedmachine.com

A25: 58 - 65 A25: 34 - 37 A25: 38 - 41

ⓘ = Imperial (in)
 ⓘ = Metric (mm)

Screws sold in multiples of 10

A DRILLING
 B BORING
 C REAMING
 D BURNISHING
 E THREADING
 X SPECIALS



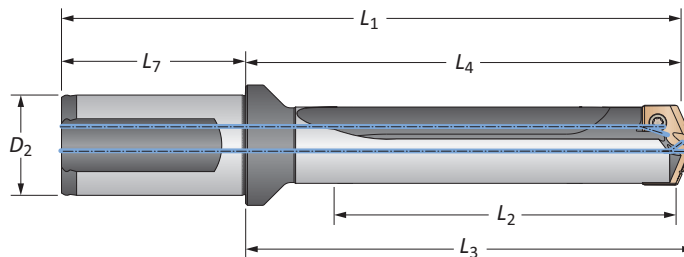

T-A Pro Drill Holders

2 Series Metric | Diameter Range: 24.38 mm - 35.04 mm

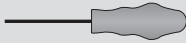

Body						Shank			Flat	Part No
Length	Sub Series	L ₂	L ₄	L ₃	L ₁	L ₇	D ₂			
STUB	A	29.7	75.0	78.6	132.9	60.0	32	Yes	HTA2A01-32FM	
STUB	A	29.7	75.0	78.6	132.9	60.0	32	No	HTA2A01-32CM	
STUB	B	29.7	75.0	78.6	132.9	60.0	32	Yes	HTA2B01-32FM	
STUB	B	29.7	75.0	78.6	132.9	60.0	32	No	HTA2B01-32CM	
STUB	C	29.7	75.0	78.6	132.9	60.0	32	Yes	HTA2C01-32FM	
STUB	C	29.7	75.0	78.6	132.9	60.0	32	No	HTA2C01-32CM	
STUB	D	29.7	75.0	78.6	132.9	60.0	32	Yes	HTA2D01-32FM	
STUB	D	29.7	75.0	78.6	132.9	60.0	32	No	HTA2D01-32CM	
3xD	A	89.2	137.4	141.0	195.4	60.0	32	Yes	HTA2A03-32FM	
3xD	A	89.2	137.4	141.0	195.4	60.0	32	No	HTA2A03-32CM	
3xD	B	89.2	137.4	141.0	195.4	60.0	32	Yes	HTA2B03-32FM	
3xD	B	89.2	137.4	141.0	195.4	60.0	32	No	HTA2B03-32CM	
3xD	C	89.2	137.4	141.0	195.4	60.0	32	Yes	HTA2C03-32FM	
3xD	C	89.2	137.4	141.0	195.4	60.0	32	No	HTA2C03-32CM	
3xD	D	89.2	137.4	141.0	195.4	60.0	32	Yes	HTA2D03-32FM	
3xD	D	89.2	137.4	141.0	195.4	60.0	32	No	HTA2D03-32CM	
5xD	A	148.7	196.9	200.5	254.8	60.0	32	Yes	HTA2A05-32FM	
5xD	A	148.7	196.9	200.5	254.8	60.0	32	No	HTA2A05-32CM	
5xD	B	148.7	196.9	200.5	254.8	60.0	32	Yes	HTA2B05-32FM	
5xD	B	148.7	196.9	200.5	254.8	60.0	32	No	HTA2B05-32CM	
5xD	C	148.7	196.9	200.5	254.8	60.0	32	Yes	HTA2C05-32FM	
5xD	C	148.7	196.9	200.5	254.8	60.0	32	No	HTA2C05-32CM	
5xD	D	148.7	196.9	200.5	254.8	60.0	32	Yes	HTA2D05-32FM	
5xD	D	148.7	196.9	200.5	254.8	60.0	32	No	HTA2D05-32CM	
7xD	A	208.2	256.4	260.0	314.3	60.0	32	Yes	HTA2A07-32FM	
7xD	A	208.2	256.4	260.0	314.3	60.0	32	No	HTA2A07-32CM	
7xD	B	208.2	256.4	260.0	314.3	60.0	32	Yes	HTA2B07-32FM	
7xD	B	208.2	256.4	260.0	314.3	60.0	32	No	HTA2B07-32CM	
7xD	C	208.2	256.4	260.0	314.3	60.0	32	Yes	HTA2C07-32FM	
7xD	C	208.2	256.4	260.0	314.3	60.0	32	No	HTA2C07-32CM	
7xD	D	208.2	256.4	260.0	314.3	60.0	32	Yes	HTA2D07-32FM	
7xD	D	208.2	256.4	260.0	314.3	60.0	32	No	HTA2D07-32CM	

Connection Accessories

					Admissible Tightening Torque*
7495-IP15-1	7495N-IP15-1	8IP-15	8IP-15TL	8IP-15B	

*Tightening torques are calculated with a friction coefficient of $\mu = 0.14$ and develop 90% of ultimate yield strength

⚠ WARNING Refer to Speed and Feed charts for recommended adjustments to speeds and feeds. Refer to page A25: 68 for deep hole drilling guidelines in this section of the catalog. Visit www.alliedmachine.com/DeepHoleGuidelines for the most up-to-date information and procedures. Factory technical assistance is available for your specific applications through our Application Engineering department.
ext: 7611 | email: appeng@alliedmachine.com

A25: 58 - 65

A25: 34 - 37

A25: 38 - 41

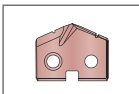
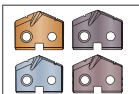
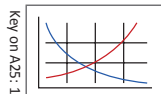

i = Imperial (in)
m = Metric (mm)

Screws sold in multiples of 10

T-A Pro Drill Holders

2 Series Metric | Diameter Range: 24.38 mm - 35.04 mm

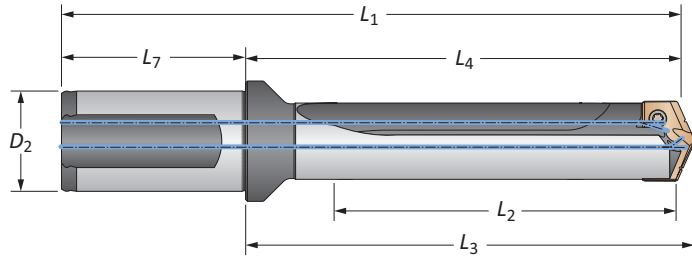

Length	Sub Series	Body				Shank			Flat	Part No
		L ₂	L ₄	L ₃	L ₁	L ₇	D ₂			
10xD	A	297.4	345.6	349.2	403.6	60.0	32	Yes	⚠ HTA2A10-32FM	
10xD	A	297.4	345.6	349.2	403.6	60.0	32	No	⚠ HTA2A10-32CM	
10xD	B	297.4	345.6	349.2	403.6	60.0	32	Yes	⚠ HTA2B10-32FM	
10xD	B	297.4	345.6	349.2	403.6	60.0	32	No	⚠ HTA2B10-32CM	
10xD	C	297.4	345.6	349.2	403.6	60.0	32	Yes	⚠ HTA2C10-32FM	
10xD	C	297.4	345.6	349.2	403.6	60.0	32	No	⚠ HTA2C10-32CM	
10xD	D	297.4	345.6	349.2	403.6	60.0	32	Yes	⚠ HTA2D10-32FM	
10xD	D	297.4	345.6	349.2	403.6	60.0	32	No	⚠ HTA2D10-32CM	
12xD	A	356.9	405.1	408.7	463.0	60.0	32	Yes	⚠ HTA2A12-32FM	
12xD	A	356.9	405.1	408.7	463.0	60.0	32	No	⚠ HTA2A12-32CM	
12xD	B	356.9	405.1	408.7	463.0	60.0	32	Yes	⚠ HTA2B12-32FM	
12xD	B	356.9	405.1	408.7	463.0	60.0	32	No	⚠ HTA2B12-32CM	
12xD	C	356.9	405.1	408.7	463.0	60.0	32	Yes	⚠ HTA2C12-32FM	
12xD	C	356.9	405.1	408.7	463.0	60.0	32	No	⚠ HTA2C12-32CM	
12xD	D	356.9	405.1	408.7	463.0	60.0	32	Yes	⚠ HTA2D12-32FM	
12xD	D	356.9	405.1	408.7	463.0	60.0	32	No	⚠ HTA2D12-32CM	
15xD	A	446.2	494.4	497.9	552.3	60.0	32	Yes	⚠ HTA2A15-32FM	
15xD	A	446.2	494.4	497.9	552.3	60.0	32	No	⚠ HTA2A15-32CM	
15xD	B	446.2	494.4	497.9	552.3	60.0	32	Yes	⚠ HTA2B15-32FM	
15xD	B	446.2	494.4	497.9	552.3	60.0	32	No	⚠ HTA2B15-32CM	
15xD	C	446.2	494.4	497.9	552.3	60.0	32	Yes	⚠ HTA2C15-32FM	
15xD	C	446.2	494.4	497.9	552.3	60.0	32	No	⚠ HTA2C15-32CM	
15xD	D	446.2	494.4	497.9	552.3	60.0	32	Yes	⚠ HTA2D15-32FM	
15xD	D	446.2	494.4	497.9	552.3	60.0	32	No	⚠ HTA2D15-32CM	

Connection Accessories

					Admissible Tightening Torque*
7495-IP15-1	7495N-IP15-1	8IP-15	8IP-15TL	8IP-15B	61.0 in-lbs (690 N-cm)

*Tightening torques are calculated with a friction coefficient of $\mu = 0.14$ and develop 90% of ultimate yield strength

⚠ WARNING Refer to Speed and Feed charts for recommended adjustments to speeds and feeds. Refer to page A25: 68 for deep hole drilling guidelines in this section of the catalog. Visit www.alliedmachine.com/DeepHoleGuidelines for the most up-to-date information and procedures. Factory technical assistance is available for your specific applications through our Application Engineering department.
ext: 7611 | email: appeng@alliedmachine.com

A25: 58 - 65 A25: 34 - 37 A25: 38 - 41





ⓘ = Imperial (in)
Ⓜ = Metric (mm)
Screws sold in multiples of 10

A DRILLING
B BORING
C REAMING
D BURNISHING
E THREADING
X SPECIALS

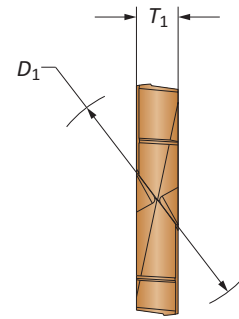
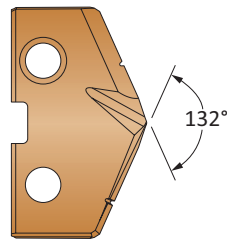
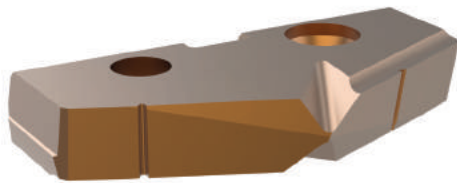
T-A Pro Carbide Drill Inserts

3 Series | Diameter Range: 1.3798" - 1.8820" (35.05 mm - 47.80 mm)



Insert								
Series	Fractional Equivalent	D_1 inch	D_1 mm	T_1	Part No. P	Part No. K	Part No. N	Part No. M
3-A		1.3819	35.10	1/4	TAP3-35.10	TAK3-35.10	TAN3-35.10	TAM3-35.10
3-A		1.3858	35.20	1/4	TAP3-35.20	TAK3-35.20	TAN3-35.20	TAM3-35.20
3-A		1.3898	35.30	1/4	TAP3-35.30	TAK3-35.30	TAN3-35.30	TAM3-35.30
3-A		1.3937	35.40	1/4	TAP3-35.40	TAK3-35.40	TAN3-35.40	TAM3-35.40
3-A		1.3976	35.50	1/4	TAP3-35.50	TAK3-35.50	TAN3-35.50	TAM3-35.50
3-A		1.4016	35.60	1/4	TAP3-35.60	TAK3-35.60	TAN3-35.60	TAM3-35.60
3-A		1.4055	35.70	1/4	TAP3-35.70	TAK3-35.70	TAN3-35.70	TAM3-35.70
3-A	1-13/32	1.4063	35.72	1/4	TAP3-35.72	TAK3-35.72	TAN3-35.72	TAM3-35.72
3-A		1.4094	35.80	1/4	TAP3-35.80	TAK3-35.80	TAN3-35.80	TAM3-35.80
3-A		1.4134	35.90	1/4	TAP3-35.90	TAK3-35.90	TAN3-35.90	TAM3-35.90
3-A		1.4173	36.00	1/4	TAP3-36.00	TAK3-36.00	TAN3-36.00	TAM3-36.00
3-A		1.4213	36.10	1/4	TAP3-36.10	TAK3-36.10	TAN3-36.10	TAM3-36.10
3-A		1.4252	36.20	1/4	TAP3-36.20	TAK3-36.20	TAN3-36.20	TAM3-36.20
3-A		1.4291	36.30	1/4	TAP3-36.30	TAK3-36.30	TAN3-36.30	TAM3-36.30
3-A		1.4331	36.40	1/4	TAP3-36.40	TAK3-36.40	TAN3-36.40	TAM3-36.40
3-A		1.4370	36.50	1/4	TAP3-36.50	TAK3-36.50	TAN3-36.50	TAM3-36.50
3-A	1-7/16	1.4374	36.51	1/4	TAP3-36.51	TAK3-36.51	TAN3-36.51	TAM3-36.51
3-A		1.4409	36.60	1/4	TAP3-36.60	TAK3-36.60	TAN3-36.60	TAM3-36.60
3-A		1.4449	36.70	1/4	TAP3-36.70	TAK3-36.70	TAN3-36.70	TAM3-36.70
3-A		1.4488	36.80	1/4	TAP3-36.80	TAK3-36.80	TAN3-36.80	TAM3-36.80
3-A		1.4528	36.90	1/4	TAP3-36.90	TAK3-36.90	TAN3-36.90	TAM3-36.90
3-A		1.4567	37.00	1/4	TAP3-37.00	TAK3-37.00	TAN3-37.00	TAM3-37.00
3-A		1.4606	37.10	1/4	TAP3-37.10	TAK3-37.10	TAN3-37.10	TAM3-37.10
3-A		1.4646	37.20	1/4	TAP3-37.20	TAK3-37.20	TAN3-37.20	TAM3-37.20
3-A		1.4685	37.30	1/4	TAP3-37.30	TAK3-37.30	TAN3-37.30	TAM3-37.30
3-A	1-15/32	1.4689	37.31	1/4	TAP3-37.31	TAK3-37.31	TAN3-37.31	TAM3-37.31
3-A		1.4724	37.40	1/4	TAP3-37.40	TAK3-37.40	TAN3-37.40	TAM3-37.40
3-A		1.4764	37.50	1/4	TAP3-37.50	TAK3-37.50	TAN3-37.50	TAM3-37.50
3-A		1.4803	37.60	1/4	TAP3-37.60	TAK3-37.60	TAN3-37.60	TAM3-37.60
3-A		1.4843	37.70	1/4	TAP3-37.70	TAK3-37.70	TAN3-37.70	TAM3-37.70

Inserts sold in multiples of 1

Sub Series Holders (A, B, C, D)

Sub series holders are recommended when running carbide inserts toward the upper end of the series drill range, as well as in tougher applications requiring more insert support and holder strength. **NOTE:** Only specified sub series inserts should be used with equivalent or smaller sub series holders.



A Series Insert +
A Series Holder



C Series Insert +
A Series Holder



C Series Insert +
C Series Holder



A Series Insert +
C Series Holder

A25: 58 - 65

A25: 54 - 57

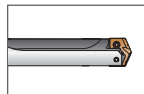
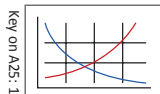

Key on A25: 1

Sizes not shown are available upon request.
When ordering, please follow the example below:





Imperial:	0.5180", Steel, 0 series = use Part No. TAP0-13.16
Metric:	13.16 mm, Steel, 0 series = use Part No. TAP0-13.16

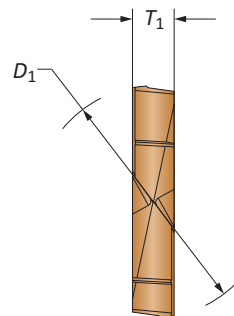
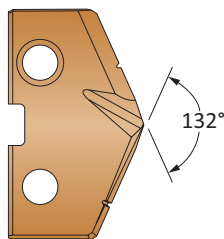
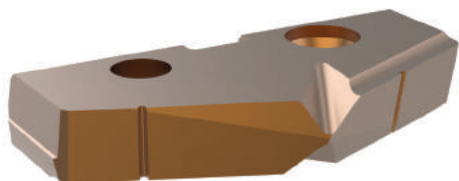

T-A Pro Carbide Drill Inserts

3 Series | Diameter Range: 1.3798" - 1.8820" (35.05 mm - 47.80 mm)



Series	Fractional Equivalent	Insert						
		D_1 inch	D_1 mm	T_1	Part No. P	Part No. K	Part No. N	Part No. M
3-B		1.4882	37.80	1/4	TAP3-37.80	TAK3-37.80	TAN3-37.80	TAM3-37.80
3-B		1.4921	37.90	1/4	TAP3-37.90	TAK3-37.90	TAN3-37.90	TAM3-37.90
3-B		1.4961	38.00	1/4	TAP3-38.00	TAK3-38.00	TAN3-38.00	TAM3-38.00
3-B	1-1/2	1.5000	38.10	1/4	TAP3-38.10	TAK3-38.10	TAN3-38.10	TAM3-38.10
3-B		1.5039	38.20	1/4	TAP3-38.20	TAK3-38.20	TAN3-38.20	TAM3-38.20
3-B		1.5079	38.30	1/4	TAP3-38.30	TAK3-38.30	TAN3-38.30	TAM3-38.30
3-B		1.5118	38.40	1/4	TAP3-38.40	TAK3-38.40	TAN3-38.40	TAM3-38.40
3-B		1.5157	38.50	1/4	TAP3-38.50	TAK3-38.50	TAN3-38.50	TAM3-38.50
3-B		1.5197	38.60	1/4	TAP3-38.60	TAK3-38.60	TAN3-38.60	TAM3-38.60
3-B		1.5236	38.70	1/4	TAP3-38.70	TAK3-38.70	TAN3-38.70	TAM3-38.70
3-B		1.5276	38.80	1/4	TAP3-38.80	TAK3-38.80	TAN3-38.80	TAM3-38.80
3-B	1-17/32	1.5311	38.89	1/4	TAP3-38.89	TAK3-38.89	TAN3-38.89	TAM3-38.89
3-B		1.5315	38.90	1/4	TAP3-38.90	TAK3-38.90	TAN3-38.90	TAM3-38.90
3-B		1.5354	39.00	1/4	TAP3-39.00	TAK3-39.00	TAN3-39.00	TAM3-39.00
3-B		1.5394	39.10	1/4	TAP3-39.10	TAK3-39.10	TAN3-39.10	TAM3-39.10
3-B		1.5433	39.20	1/4	TAP3-39.20	TAK3-39.20	TAN3-39.20	TAM3-39.20
3-B		1.5469	39.29	1/4	TAP3-39.29	TAK3-39.29	TAN3-39.29	TAM3-39.29
3-B		1.5472	39.30	1/4	TAP3-39.30	TAK3-39.30	TAN3-39.30	TAM3-39.30
3-B		1.5512	39.40	1/4	TAP3-39.40	TAK3-39.40	TAN3-39.40	TAM3-39.40
3-B		1.5551	39.50	1/4	TAP3-39.50	TAK3-39.50	TAN3-39.50	TAM3-39.50
3-B		1.5591	39.60	1/4	TAP3-39.60	TAK3-39.60	TAN3-39.60	TAM3-39.60
3-B	1-9/16	1.5626	39.69	1/4	TAP3-39.69	TAK3-39.69	TAN3-39.69	TAM3-39.69
3-B		1.5630	39.70	1/4	TAP3-39.70	TAK3-39.70	TAN3-39.70	TAM3-39.70
3-B		1.5669	39.80	1/4	TAP3-39.80	TAK3-39.80	TAN3-39.80	TAM3-39.80
3-B		1.5709	39.90	1/4	TAP3-39.90	TAK3-39.90	TAN3-39.90	TAM3-39.90
3-B		1.5748	40.00	1/4	TAP3-40.00	TAK3-40.00	TAN3-40.00	TAM3-40.00
3-B		1.5787	40.10	1/4	TAP3-40.10	TAK3-40.10	TAN3-40.10	TAM3-40.10
3-B		1.5827	40.20	1/4	TAP3-40.20	TAK3-40.20	TAN3-40.20	TAM3-40.20
3-B		1.5866	40.30	1/4	TAP3-40.30	TAK3-40.30	TAN3-40.30	TAM3-40.30
3-B		1.5906	40.40	1/4	TAP3-40.40	TAK3-40.40	TAN3-40.40	TAM3-40.40
3-B	1-19/32	1.5937	40.48	1/4	TAP3-40.48	TAK3-40.48	TAN3-40.48	TAM3-40.48
3-B		1.5945	40.50	1/4	TAP3-40.50	TAK3-40.50	TAN3-40.50	TAM3-40.50
3-B		1.5984	40.60	1/4	TAP3-40.60	TAK3-40.60	TAN3-40.60	TAM3-40.60
3-B		1.6024	40.70	1/4	TAP3-40.70	TAK3-40.70	TAN3-40.70	TAM3-40.70
3-B		1.6063	40.80	1/4	TAP3-40.80	TAK3-40.80	TAN3-40.80	TAM3-40.80
3-B		1.6102	40.90	1/4	TAP3-40.90	TAK3-40.90	TAN3-40.90	TAM3-40.90

Inserts sold in multiples of 1

Sub Series Holders (A, B, C, D)

Sub series holders are recommended when running carbide inserts toward the upper end of the series drill range, as well as in tougher applications requiring more insert support and holder strength. **NOTE:** Only specified sub series inserts should be used with equivalent or smaller sub series holders.



A Series Insert + A Series Holder



C Series Insert + A Series Holder



C Series Insert + C Series Holder



A Series Insert + C Series Holder

A25: 58 - 65

A25: 54 - 57

Key on A25: 1

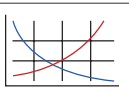





Sizes not shown are available upon request. When ordering, please follow the example below:

Imperial:	0.5180", Steel, 0 series = use Part No. TAP0-13.16
Metric:	13.16 mm, Steel, 0 series = use Part No. TAP0-13.16

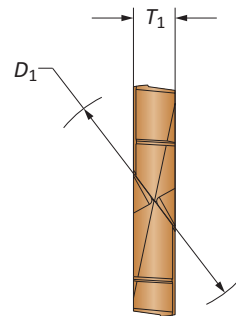
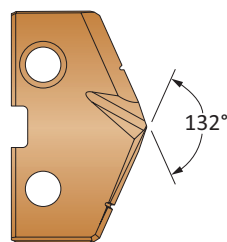
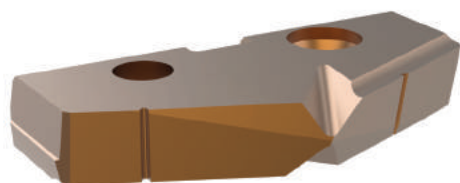
T-A Pro Carbide Drill Inserts

3 Series | Diameter Range: 1.3798" - 1.8820" (35.05 mm - 47.80 mm)



Insert								
Series	Fractional Equivalent	D ₁ inch	D ₁ mm	T ₁	Part No. P	Part No. K	Part No. N	Part No. M
3-C		1.6142	41.00	1/4	TAP3-41.00	TAK3-41.00	TAN3-41.00	TAM3-41.00
3-C		1.6181	41.10	1/4	TAP3-41.10	TAK3-41.10	TAN3-41.10	TAM3-41.10
3-C		1.6220	41.20	1/4	TAP3-41.20	TAK3-41.20	TAN3-41.20	TAM3-41.20
3-C	1-5/8	1.6252	41.28	1/4	TAP3-41.28	TAK3-41.28	TAN3-41.28	TAM3-41.28
3-C		1.6260	41.30	1/4	TAP3-41.30	TAK3-41.30	TAN3-41.30	TAM3-41.30
3-C		1.6299	41.40	1/4	TAP3-41.40	TAK3-41.40	TAN3-41.40	TAM3-41.40
3-C		1.6339	41.50	1/4	TAP3-41.50	TAK3-41.50	TAN3-41.50	TAM3-41.50
3-C		1.6378	41.60	1/4	TAP3-41.60	TAK3-41.60	TAN3-41.60	TAM3-41.60
3-C		1.6417	41.70	1/4	TAP3-41.70	TAK3-41.70	TAN3-41.70	TAM3-41.70
3-C		1.6457	41.80	1/4	TAP3-41.80	TAK3-41.80	TAN3-41.80	TAM3-41.80
3-C		1.6496	41.90	1/4	TAP3-41.90	TAK3-41.90	TAN3-41.90	TAM3-41.90
3-C		1.6535	42.00	1/4	TAP3-42.00	TAK3-42.00	TAN3-42.00	TAM3-42.00
3-C	1-21/32	1.6563	42.07	1/4	TAP3-42.07	TAK3-42.07	TAN3-42.07	TAM3-42.07
3-C		1.6575	42.10	1/4	TAP3-42.10	TAK3-42.10	TAN3-42.10	TAM3-42.10
3-C		1.6614	42.20	1/4	TAP3-42.20	TAK3-42.20	TAN3-42.20	TAM3-42.20
3-C		1.6654	42.30	1/4	TAP3-42.30	TAK3-42.30	TAN3-42.30	TAM3-42.30
3-C		1.6693	42.40	1/4	TAP3-42.40	TAK3-42.40	TAN3-42.40	TAM3-42.40
3-C		1.6732	42.50	1/4	TAP3-42.50	TAK3-42.50	TAN3-42.50	TAM3-42.50
3-C		1.6772	42.60	1/4	TAP3-42.60	TAK3-42.60	TAN3-42.60	TAM3-42.60
3-C		1.6811	42.70	1/4	TAP3-42.70	TAK3-42.70	TAN3-42.70	TAM3-42.70
3-C		1.6850	42.80	1/4	TAP3-42.80	TAK3-42.80	TAN3-42.80	TAM3-42.80
3-C	1-11/16	1.6874	42.86	1/4	TAP3-42.86	TAK3-42.86	TAN3-42.86	TAM3-42.86
3-C		1.6890	42.90	1/4	TAP3-42.90	TAK3-42.90	TAN3-42.90	TAM3-42.90
3-C		1.6929	43.00	1/4	TAP3-43.00	TAK3-43.00	TAN3-43.00	TAM3-43.00
3-C		1.6969	43.10	1/4	TAP3-43.10	TAK3-43.10	TAN3-43.10	TAM3-43.10
3-C		1.7008	43.20	1/4	TAP3-43.20	TAK3-43.20	TAN3-43.20	TAM3-43.20
3-C		1.7047	43.30	1/4	TAP3-43.30	TAK3-43.30	TAN3-43.30	TAM3-43.30
3-C		1.7087	43.40	1/4	TAP3-43.40	TAK3-43.40	TAN3-43.40	TAM3-43.40
3-C		1.7126	43.50	1/4	TAP3-43.50	TAK3-43.50	TAN3-43.50	TAM3-43.50
3-C		1.7165	43.60	1/4	TAP3-43.60	TAK3-43.60	TAN3-43.60	TAM3-43.60
3-C	1-23/32	1.7189	43.66	1/4	TAP3-43.66	TAK3-43.66	TAN3-43.66	TAM3-43.66
3-C		1.7205	43.70	1/4	TAP3-43.70	TAK3-43.70	TAN3-43.70	TAM3-43.70
3-C		1.7244	43.80	1/4	TAP3-43.80	TAK3-43.80	TAN3-43.80	TAM3-43.80
3-C		1.7283	43.90	1/4	TAP3-43.90	TAK3-43.90	TAN3-43.90	TAM3-43.90
3-C		1.7323	44.00	1/4	TAP3-44.00	TAK3-44.00	TAN3-44.00	TAM3-44.00
3-C		1.7362	44.10	1/4	TAP3-44.10	TAK3-44.10	TAN3-44.10	TAM3-44.10
3-C		1.7402	44.20	1/4	TAP3-44.20	TAK3-44.20	TAN3-44.20	TAM3-44.20
3-C		1.7441	44.30	1/4	TAP3-44.30	TAK3-44.30	TAN3-44.30	TAM3-44.30

Inserts sold in multiples of 1

Sub Series Holders (A, B, C, D)

Sub series holders are recommended when running carbide inserts toward the upper end of the series drill range, as well as in tougher applications requiring more insert support and holder strength. **NOTE:** Only specified sub series inserts should be used with equivalent or smaller sub series holders.



A Series Insert + A Series Holder



C Series Insert + A Series Holder



C Series Insert + C Series Holder



A Series Insert + C Series Holder

A25: 58 - 65

A25: 54 - 57

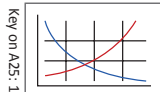

Sizes not shown are available upon request. When ordering, please follow the example below:





Imperial:	0.5180", Steel, 0 series = use Part No. TAP0-13.16
Metric:	13.16 mm, Steel, 0 series = use Part No. TAP0-13.16

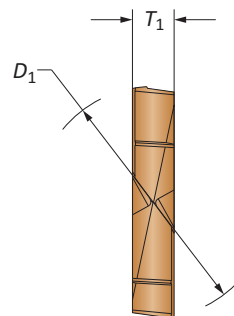
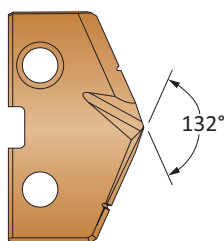
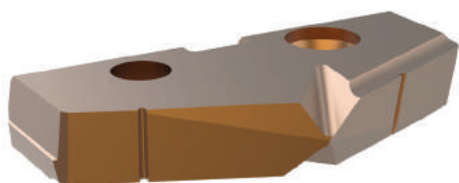

T-A Pro Carbide Drill Inserts

3 Series | Diameter Range: 1.3798" - 1.8820" (35.05 mm - 47.80 mm)



Insert								
Series	Fractional Equivalent	D ₁ inch	D ₁ mm	T ₁	Part No. P	Part No. K	Part No. N	Part No. M
3-D		1.7480	44.40	1/4	TAP3-44.40	TAK3-44.40	TAN3-44.40	TAM3-44.40
3-D	1-3/4	1.7500	44.45	1/4	TAP3-44.45	TAK3-44.45	TAN3-44.45	TAM3-44.45
3-D		1.7520	44.50	1/4	TAP3-44.50	TAK3-44.50	TAN3-44.50	TAM3-44.50
3-D		1.7559	44.60	1/4	TAP3-44.60	TAK3-44.60	TAN3-44.60	TAM3-44.60
3-D		1.7598	44.70	1/4	TAP3-44.70	TAK3-44.70	TAN3-44.70	TAM3-44.70
3-D		1.7638	44.80	1/4	TAP3-44.80	TAK3-44.80	TAN3-44.80	TAM3-44.80
3-D		1.7677	44.90	1/4	TAP3-44.90	TAK3-44.90	TAN3-44.90	TAM3-44.90
3-D		1.7717	45.00	1/4	TAP3-45.00	TAK3-45.00	TAN3-45.00	TAM3-45.00
3-D		1.7756	45.10	1/4	TAP3-45.10	TAK3-45.10	TAN3-45.10	TAM3-45.10
3-D		1.7795	45.20	1/4	TAP3-45.20	TAK3-45.20	TAN3-45.20	TAM3-45.20
3-D	1-25/32	1.7811	45.24	1/4	TAP3-45.24	TAK3-45.24	TAN3-45.24	TAM3-45.24
3-D		1.7835	45.30	1/4	TAP3-45.30	TAK3-45.30	TAN3-45.30	TAM3-45.30
3-D		1.7874	45.40	1/4	TAP3-45.40	TAK3-45.40	TAN3-45.40	TAM3-45.40
3-D		1.7913	45.50	1/4	TAP3-45.50	TAK3-45.50	TAN3-45.50	TAM3-45.50
3-D		1.7913	45.50	1/4	TAP3-45.50	TAK3-45.50	TAN3-45.50	TAM3-45.50
3-D		1.7953	45.60	1/4	TAP3-45.60	TAK3-45.60	TAN3-45.60	TAM3-45.60
3-D		1.7969	45.64	1/4	TAP3-45.64	TAK3-45.64	TAN3-45.64	TAM3-45.64
3-D		1.7992	45.70	1/4	TAP3-45.70	TAK3-45.70	TAN3-45.70	TAM3-45.70
3-D		1.8031	45.80	1/4	TAP3-45.80	TAK3-45.80	TAN3-45.80	TAM3-45.80
3-D		1.8071	45.90	1/4	TAP3-45.90	TAK3-45.90	TAN3-45.90	TAM3-45.90
3-D		1.8110	46.00	1/4	TAP3-46.00	TAK3-46.00	TAN3-46.00	TAM3-46.00
3-D	1-13/16	1.8126	46.04	1/4	TAP3-46.04	TAK3-46.04	TAN3-46.04	TAM3-46.04
3-D		1.8150	46.10	1/4	TAP3-46.10	TAK3-46.10	TAN3-46.10	TAM3-46.10
3-D		1.8189	46.20	1/4	TAP3-46.20	TAK3-46.20	TAN3-46.20	TAM3-46.20
3-D		1.8228	46.30	1/4	TAP3-46.30	TAK3-46.30	TAN3-46.30	TAM3-46.30
3-D		1.8268	46.40	1/4	TAP3-46.40	TAK3-46.40	TAN3-46.40	TAM3-46.40
3-D		1.8307	46.50	1/4	TAP3-46.50	TAK3-46.50	TAN3-46.50	TAM3-46.50
3-D		1.8346	46.60	1/4	TAP3-46.60	TAK3-46.60	TAN3-46.60	TAM3-46.60
3-D		1.8386	46.70	1/4	TAP3-46.70	TAK3-46.70	TAN3-46.70	TAM3-46.70
3-D		1.8425	46.80	1/4	TAP3-46.80	TAK3-46.80	TAN3-46.80	TAM3-46.80
3-D	1-27/32	1.8437	46.83	1/4	TAP3-46.83	TAK3-46.83	TAN3-46.83	TAM3-46.83
3-D		1.8465	46.90	1/4	TAP3-46.90	TAK3-46.90	TAN3-46.90	TAM3-46.90
3-D		1.8504	47.00	1/4	TAP3-47.00	TAK3-47.00	TAN3-47.00	TAM3-47.00
3-D		1.8543	47.10	1/4	TAP3-47.10	TAK3-47.10	TAN3-47.10	TAM3-47.10
3-D		1.8583	47.20	1/4	TAP3-47.20	TAK3-47.20	TAN3-47.20	TAM3-47.20
3-D		1.8622	47.30	1/4	TAP3-47.30	TAK3-47.30	TAN3-47.30	TAM3-47.30
3-D		1.8661	47.40	1/4	TAP3-47.40	TAK3-47.40	TAN3-47.40	TAM3-47.40
3-D		1.8701	47.50	1/4	TAP3-47.50	TAK3-47.50	TAN3-47.50	TAM3-47.50
3-D		1.8740	47.60	1/4	TAP3-47.60	TAK3-47.60	TAN3-47.60	TAM3-47.60
3-D	1-7/8	1.8752	47.63	1/4	TAP3-47.63	TAK3-47.63	TAN3-47.63	TAM3-47.63

Inserts sold in multiples of 1

Sub Series Holders (A, B, C, D)

Sub series holders are recommended when running carbide inserts toward the upper end of the series drill range, as well as in tougher applications requiring more insert support and holder strength. **NOTE:** Only specified sub series inserts should be used with equivalent or smaller sub series holders.



A Series Insert + A Series Holder



C Series Insert + A Series Holder



C Series Insert + C Series Holder



A Series Insert + C Series Holder

A25: 58 - 65

A25: 54 - 57

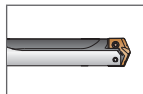
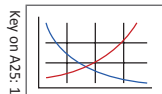

Sizes not shown are available upon request.

When ordering, please follow the example below:

Imperial:	0.5180", Steel, 0 series = use Part No. TAP0-13.16
Metric:	13.16 mm, Steel, 0 series = use Part No. TAP0-13.16

T-A Pro HSS Drill Inserts

3 Series | Diameter Range: 1.3798" - 1.8820" (35.05 mm - 47.80 mm)

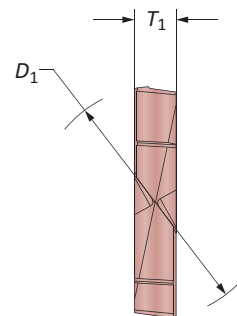
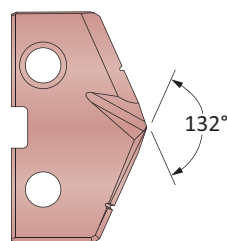
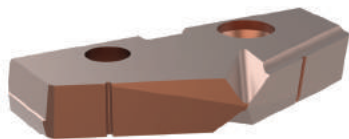

Insert					
Series	Fractional Equivalent	D_1 inch	D_1 mm	T_1	Part No.
3-A		1.3819	35.10	1/4	X TAX3-35.10
3-A		1.3858	35.20	1/4	TAX3-35.20
3-A		1.3898	35.30	1/4	TAX3-35.30
3-A		1.3937	35.40	1/4	TAX3-35.40
3-A		1.3976	35.50	1/4	TAX3-35.50
3-A		1.4016	35.60	1/4	TAX3-35.60
3-A		1.4055	35.70	1/4	TAX3-35.70
3-A	1-13/32	1.4063	35.72	1/4	TAX3-35.72
3-A		1.4094	35.80	1/4	TAX3-35.80
3-A		1.4134	35.90	1/4	TAX3-35.90
3-A		1.4173	36.00	1/4	TAX3-36.00
3-A		1.4213	36.10	1/4	TAX3-36.10
3-A		1.4252	36.20	1/4	TAX3-36.20
3-A		1.4291	36.30	1/4	TAX3-36.30
3-A		1.4331	36.40	1/4	TAX3-36.40
3-A		1.4370	36.50	1/4	TAX3-36.50
3-A	1-7/16	1.4374	36.51	1/4	TAX3-36.51
3-A		1.4409	36.60	1/4	TAX3-36.60
3-A		1.4449	36.70	1/4	TAX3-36.70
3-A		1.4488	36.80	1/4	TAX3-36.80
3-A		1.4528	36.90	1/4	TAX3-36.90
3-A		1.4567	37.00	1/4	TAX3-37.00
3-A		1.4606	37.10	1/4	TAX3-37.10
3-A		1.4646	37.20	1/4	TAX3-37.20
3-A		1.4685	37.30	1/4	TAX3-37.30
3-A	1-15/32	1.4689	37.31	1/4	TAX3-37.31
3-A		1.4724	37.40	1/4	TAX3-37.40
3-A		1.4764	37.50	1/4	TAX3-37.50
3-A		1.4803	37.60	1/4	TAX3-37.60
3-A		1.4843	37.70	1/4	TAX3-37.70

Inserts sold in multiples of 1

Sub Series Holders (A, B, C, D)

Sub series holders are recommended when running carbide inserts toward the upper end of the series drill range, as well as in tougher applications requiring more insert support and holder strength. **NOTE:** Only specified sub series inserts should be used with equivalent or smaller sub series holders.



A Series Insert +
A Series Holder



C Series Insert +
A Series Holder



C Series Insert +
C Series Holder



A Series Insert +
C Series Holder

A25: 58 - 65

A25: 54 - 57

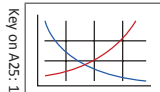

Sizes not shown are available upon request.
When ordering, please follow the example below:

Imperial:	0.5180", Steel, 0 series = use Part No. TAP0-13.16
Metric:	13.16 mm, Steel, 0 series = use Part No. TAP0-13.16



T-A Pro HSS Drill Inserts

3 Series | Diameter Range: 1.3798" - 1.8820" (35.05 mm - 47.80 mm)

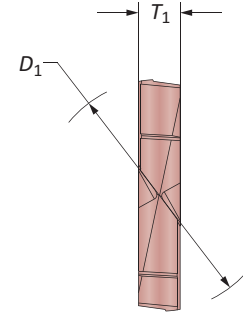
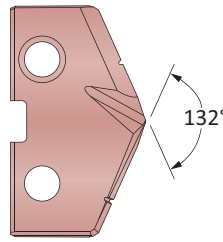
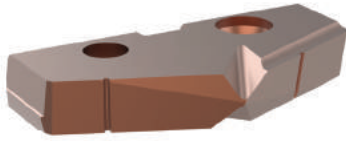

Series	Fractional Equivalent	Insert			Part No.
		D ₁ inch	D ₁ mm	T ₁	
3-B		1.4882	37.80	1/4	TAX3-37.80
3-B		1.4921	37.90	1/4	TAX3-37.90
3-B		1.4961	38.00	1/4	TAX3-38.00
3-B	1-1/2	1.5000	38.10	1/4	TAX3-38.10
3-B		1.5039	38.20	1/4	TAX3-38.20
3-B		1.5079	38.30	1/4	TAX3-38.30
3-B		1.5118	38.40	1/4	TAX3-38.40
3-B		1.5157	38.50	1/4	TAX3-38.50
3-B		1.5197	38.60	1/4	TAX3-38.60
3-B		1.5236	38.70	1/4	TAX3-38.70
3-B		1.5276	38.80	1/4	TAX3-38.80
3-B	1-17/32	1.5311	38.89	1/4	TAX3-38.89
3-B		1.5315	38.90	1/4	TAX3-38.90
3-B		1.5354	39.00	1/4	TAX3-39.00
3-B		1.5394	39.10	1/4	TAX3-39.10
3-B		1.5433	39.20	1/4	TAX3-39.20
3-B		1.5469	39.29	1/4	TAX3-39.29
3-B		1.5472	39.30	1/4	TAX3-39.30
3-B		1.5512	39.40	1/4	TAX3-39.40
3-B		1.5551	39.50	1/4	TAX3-39.50
3-B		1.5591	39.60	1/4	TAX3-39.60
3-B	1-9/16	1.5626	39.69	1/4	TAX3-39.69
3-B		1.5630	39.70	1/4	TAX3-39.70
3-B		1.5669	39.80	1/4	TAX3-39.80
3-B		1.5709	39.90	1/4	TAX3-39.90
3-B		1.5748	40.00	1/4	TAX3-40.00
3-B		1.5787	40.10	1/4	TAX3-40.10
3-B		1.5827	40.20	1/4	TAX3-40.20
3-B		1.5866	40.30	1/4	TAX3-40.30
3-B		1.5906	40.40	1/4	TAX3-40.40
3-B	1-19/32	1.5937	40.48	1/4	TAX3-40.48
3-B		1.5945	40.50	1/4	TAX3-40.50
3-B		1.5984	40.60	1/4	TAX3-40.60
3-B		1.6024	40.70	1/4	TAX3-40.70
3-B		1.6063	40.80	1/4	TAX3-40.80
3-B		1.6102	40.90	1/4	TAX3-40.90

Inserts sold in multiples of 1

Sub Series Holders (A, B, C, D)

Sub series holders are recommended when running carbide inserts toward the upper end of the series drill range, as well as in tougher applications requiring more insert support and holder strength. **NOTE:** Only specified sub series inserts should be used with equivalent or smaller sub series holders.



A Series Insert + A Series Holder



C Series Insert + A Series Holder



C Series Insert + C Series Holder



A Series Insert + C Series Holder

A25: 58 - 65

A25: 54 - 57

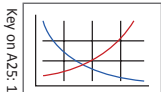



Sizes not shown are available upon request. When ordering, please follow the example below:

Imperial:	0.5180", Steel, 0 series = use Part No. TAP0-13.16
Metric:	13.16 mm, Steel, 0 series = use Part No. TAP0-13.16

T-A Pro HSS Drill Inserts

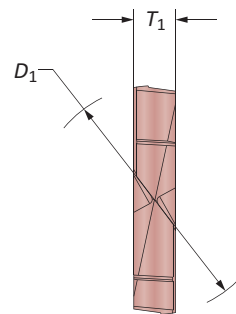
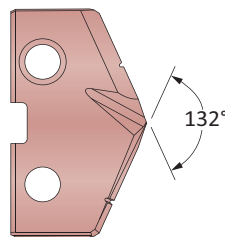
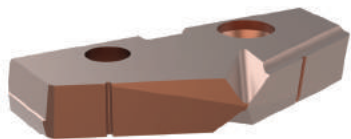
3 Series | Diameter Range: 1.3798" - 1.8820" (35.05 mm - 47.80 mm)



Insert					
Series	Fractional Equivalent	D ₁ inch	D ₁ mm	T ₁	Part No.
3-C		1.6142	41.00	1/4	X TAX3-41.00
3-C		1.6181	41.10	1/4	TAX3-41.10
3-C		1.6220	41.20	1/4	TAX3-41.20
3-C	1-5/8	1.6252	41.28	1/4	TAX3-41.28
3-C		1.6260	41.30	1/4	TAX3-41.30
3-C		1.6299	41.40	1/4	TAX3-41.40
3-C		1.6339	41.50	1/4	TAX3-41.50
3-C		1.6378	41.60	1/4	TAX3-41.60
3-C		1.6417	41.70	1/4	TAX3-41.70
3-C		1.6457	41.80	1/4	TAX3-41.80
3-C		1.6496	41.90	1/4	TAX3-41.90
3-C		1.6535	42.00	1/4	TAX3-42.00
3-C	1-21/32	1.6563	42.07	1/4	TAX3-42.07
3-C		1.6575	42.10	1/4	TAX3-42.10
3-C		1.6614	42.20	1/4	TAX3-42.20
3-C		1.6654	42.30	1/4	TAX3-42.30
3-C		1.6693	42.40	1/4	TAX3-42.40
3-C		1.6732	42.50	1/4	TAX3-42.50
3-C		1.6772	42.60	1/4	TAX3-42.60
3-C		1.6811	42.70	1/4	TAX3-42.70
3-C		1.6850	42.80	1/4	TAX3-42.80
3-C	1-11/16	1.6874	42.86	1/4	TAX3-42.86
3-C		1.6890	42.90	1/4	TAX3-42.90
3-C		1.6929	43.00	1/4	TAX3-43.00
3-C		1.6969	43.10	1/4	TAX3-43.10
3-C		1.7008	43.20	1/4	TAX3-43.20
3-C		1.7047	43.30	1/4	TAX3-43.30
3-C		1.7087	43.40	1/4	TAX3-43.40
3-C		1.7126	43.50	1/4	TAX3-43.50
3-C		1.7165	43.60	1/4	TAX3-43.60
3-C	1-23/32	1.7189	43.66	1/4	TAX3-43.66
3-C		1.7205	43.70	1/4	TAX3-43.70
3-C		1.7244	43.80	1/4	TAX3-43.80
3-C		1.7283	43.90	1/4	TAX3-43.90
3-C		1.7323	44.00	1/4	TAX3-44.00
3-C		1.7362	44.10	1/4	TAX3-44.10
3-C		1.7402	44.20	1/4	TAX3-44.20
3-C		1.7441	44.30	1/4	TAX3-44.30

Inserts sold in multiples of 1

Sub Series Holders (A, B, C, D)

Sub series holders are recommended when running carbide inserts toward the upper end of the series drill range, as well as in tougher applications requiring more insert support and holder strength. **NOTE:** Only specified sub series inserts should be used with equivalent or smaller sub series holders.



A Series Insert +
A Series Holder



C Series Insert +
A Series Holder



C Series Insert +
C Series Holder



A Series Insert +
C Series Holder

A25: 58 - 65

A25: 54 - 57

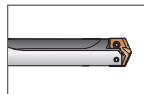
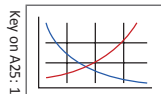

Sizes not shown are available upon request.

When ordering, please follow the example below:

Imperial:	0.5180", Steel, 0 series = use Part No. TAP0-13.16
Metric:	13.16 mm, Steel, 0 series = use Part No. TAP0-13.16



T-A Pro HSS Drill Inserts

3 Series | Diameter Range: 1.3798" - 1.8820" (35.05 mm - 47.80 mm)

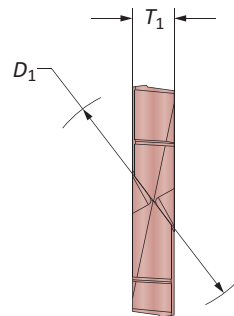
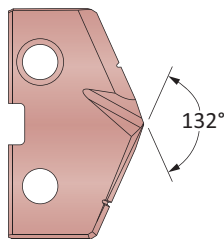
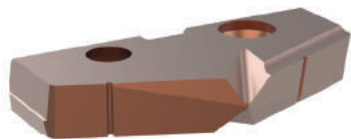

Insert					
Series	Fractional Equivalent	D ₁ inch	D ₁ mm	T ₁	Part No. X
3-D		1.7480	44.40	1/4	TAX3-44.40
3-D	1-3/4	1.7500	44.45	1/4	TAX3-44.45
3-D		1.7520	44.50	1/4	TAX3-44.50
3-D		1.7559	44.60	1/4	TAX3-44.60
3-D		1.7598	44.70	1/4	TAX3-44.70
3-D		1.7638	44.80	1/4	TAX3-44.80
3-D		1.7677	44.90	1/4	TAX3-44.90
3-D		1.7717	45.00	1/4	TAX3-45.00
3-D		1.7756	45.10	1/4	TAX3-45.10
3-D		1.7795	45.20	1/4	TAX3-45.20
3-D	1-25/32	1.7811	45.24	1/4	TAX3-45.24
3-D		1.7835	45.30	1/4	TAX3-45.30
3-D		1.7874	45.40	1/4	TAX3-45.40
3-D		1.7913	45.50	1/4	TAX3-45.50
3-D		1.7913	45.50	1/4	TAX3-45.50
3-D		1.7953	45.60	1/4	TAX3-45.60
3-D		1.7969	45.64	1/4	TAX3-45.64
3-D		1.7992	45.70	1/4	TAX3-45.70
3-D		1.8031	45.80	1/4	TAX3-45.80
3-D		1.8071	45.90	1/4	TAX3-45.90
3-D		1.8110	46.00	1/4	TAX3-46.00
3-D	1-13/16	1.8126	46.04	1/4	TAX3-46.04
3-D		1.8150	46.10	1/4	TAX3-46.10
3-D		1.8189	46.20	1/4	TAX3-46.20
3-D		1.8228	46.30	1/4	TAX3-46.30
3-D		1.8268	46.40	1/4	TAX3-46.40
3-D		1.8307	46.50	1/4	TAX3-46.50
3-D		1.8346	46.60	1/4	TAX3-46.60
3-D		1.8386	46.70	1/4	TAX3-46.70
3-D		1.8425	46.80	1/4	TAX3-46.80
3-D	1-27/32	1.8437	46.83	1/4	TAX3-46.83
3-D		1.8465	46.90	1/4	TAX3-46.90
3-D		1.8504	47.00	1/4	TAX3-47.00
3-D		1.8543	47.10	1/4	TAX3-47.10
3-D		1.8583	47.20	1/4	TAX3-47.20
3-D		1.8622	47.30	1/4	TAX3-47.30
3-D		1.8661	47.40	1/4	TAX3-47.40
3-D		1.8701	47.50	1/4	TAX3-47.50
3-D		1.8740	47.60	1/4	TAX3-47.60
3-D	1-7/8	1.8752	47.63	1/4	TAX3-47.63

Inserts sold in multiples of 1

Sub Series Holders (A, B, C, D)

Sub series holders are recommended when running carbide inserts toward the upper end of the series drill range, as well as in tougher applications requiring more insert support and holder strength. **NOTE:** Only specified sub series inserts should be used with equivalent or smaller sub series holders.



A Series Insert + A Series Holder



C Series Insert + A Series Holder



C Series Insert + C Series Holder



A Series Insert + C Series Holder

A25: 58 - 65

A25: 54 - 57

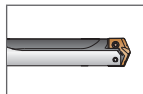
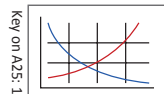

Sizes not shown are available upon request.

When ordering, please follow the example below:

Imperial:	0.5180", Steel, 0 series = use Part No. TAP0-13.16
Metric:	13.16 mm, Steel, 0 series = use Part No. TAP0-13.16

T-A Pro Drill Holders

3 Series Imperial | Diameter Range: 1.3798" - 1.8820"

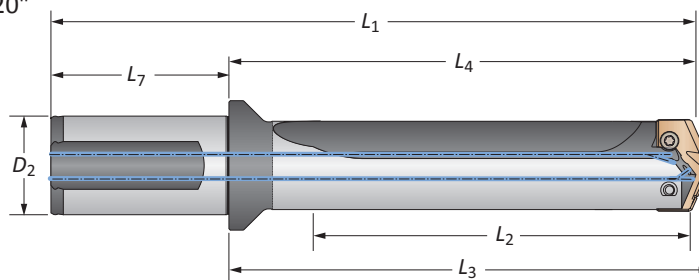

		Body				Shank				
Length	Sub Series	L ₂	L ₄	L ₃	L ₁	L ₇	D ₂	Flat	Part No	
STUB	A	1.618	3.634	3.821	6.322	2.688	1-1/2	Yes	HTA3A01-150F	
STUB	A	1.618	3.634	3.821	6.322	2.688	1-1/2	No	HTA3A01-150C	
STUB	B	1.618	3.634	3.821	6.322	2.688	1-1/2	Yes	HTA3B01-150F	
STUB	B	1.618	3.634	3.821	6.322	2.688	1-1/2	No	HTA3B01-150C	
STUB	C	1.618	3.634	3.821	6.322	2.688	1-1/2	Yes	HTA3C01-150F	
STUB	C	1.618	3.634	3.821	6.322	2.688	1-1/2	No	HTA3C01-150C	
STUB	D	1.618	3.634	3.821	6.322	2.688	1-1/2	Yes	HTA3D01-150F	
STUB	D	1.618	3.634	3.821	6.322	2.688	1-1/2	No	HTA3D01-150C	
3xD	A	4.854	7.089	7.276	9.777	2.688	1-1/2	Yes	HTA3A03-150F	
3xD	A	4.854	7.089	7.276	9.777	2.688	1-1/2	No	HTA3A03-150C	
3xD	B	4.854	7.089	7.276	9.777	2.688	1-1/2	Yes	HTA3B03-150F	
3xD	B	4.854	7.089	7.276	9.777	2.688	1-1/2	No	HTA3B03-150C	
3xD	C	4.854	7.089	7.276	9.777	2.688	1-1/2	Yes	HTA3C03-150F	
3xD	C	4.854	7.089	7.276	9.777	2.688	1-1/2	No	HTA3C03-150C	
3xD	D	4.854	7.089	7.276	9.777	2.688	1-1/2	Yes	HTA3D03-150F	
3xD	D	4.854	7.089	7.276	9.777	2.688	1-1/2	No	HTA3D03-150C	
5xD	A	8.090	10.325	10.512	13.013	2.688	1-1/2	Yes	HTA3A05-150F	
5xD	A	8.090	10.325	10.512	13.013	2.688	1-1/2	No	HTA3A05-150C	
5xD	B	8.090	10.325	10.512	13.013	2.688	1-1/2	Yes	HTA3B05-150F	
5xD	B	8.090	10.325	10.512	13.013	2.688	1-1/2	No	HTA3B05-150C	
5xD	C	8.090	10.325	10.512	13.013	2.688	1-1/2	Yes	HTA3C05-150F	
5xD	C	8.090	10.325	10.512	13.013	2.688	1-1/2	No	HTA3C05-150C	
5xD	D	8.090	10.325	10.512	13.013	2.688	1-1/2	Yes	HTA3D05-150F	
5xD	D	8.090	10.325	10.512	13.013	2.688	1-1/2	No	HTA3D05-150C	
7xD	A	11.326	13.561	13.748	16.249	2.688	1-1/2	Yes	HTA3A07-150F	
7xD	A	11.326	13.561	13.748	16.249	2.688	1-1/2	No	HTA3A07-150C	
7xD	B	11.326	13.561	13.748	16.249	2.688	1-1/2	Yes	HTA3B07-150F	
7xD	B	11.326	13.561	13.748	16.249	2.688	1-1/2	No	HTA3B07-150C	
7xD	C	11.326	13.561	13.748	16.249	2.688	1-1/2	Yes	HTA3C07-150F	
7xD	C	11.326	13.561	13.748	16.249	2.688	1-1/2	No	HTA3C07-150C	
7xD	D	11.326	13.561	13.748	16.249	2.688	1-1/2	Yes	HTA3D07-150F	
7xD	D	11.326	13.561	13.748	16.249	2.688	1-1/2	No	HTA3D07-150C	

Connection Accessories

			Admissible Tightening Torque*
Insert Screws	Nylon Locking Screws	Insert Driver	
7514-IP20-1	7514N-IP20-1	8IP-20	121.3 in-lbs (1370 N-cm)

*Tightening torques are calculated with a friction coefficient of $\mu = 0.14$ and develop 90% of ultimate yield strength

WARNING Refer to Speed and Feed charts for recommended adjustments to speeds and feeds. Refer to page A25: 68 for deep hole drilling guidelines in this section of the catalog. Visit www.alliedmachine.com/DeepHoleGuidelines for the most up-to-date information and procedures. Factory technical assistance is available for your specific applications through our Application Engineering department. ext: 7611 | email: appeng@alliedmachine.com

A25: 58 - 65 A25: 46 - 49 A25: 50 - 53

Key on A25: 1

i = Imperial (in)
m = Metric (mm)

Screws sold in multiples of 10

T-A Pro Drill Holders

3 Series Imperial | Diameter Range: 1.3798" - 1.8820"

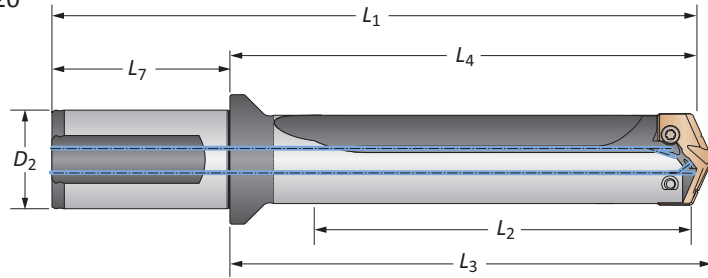

Body		Shank			Flat	Part No			
Length	Sub Series	L ₂	L ₄	L ₃			L ₁	L ₇	D ₂
10xD	A	16.180	18.415	18.602	21.103	2.688	1-1/2	Yes	HTA3A10-150F
10xD	A	16.180	18.415	18.602	21.103	2.688	1-1/2	No	HTA3A10-150C
10xD	B	16.180	18.415	18.602	21.103	2.688	1-1/2	Yes	HTA3B10-150F
10xD	B	16.180	18.415	18.602	21.103	2.688	1-1/2	No	HTA3B10-150C
10xD	C	16.180	18.415	18.602	21.103	2.688	1-1/2	Yes	HTA3C10-150F
10xD	C	16.180	18.415	18.602	21.103	2.688	1-1/2	No	HTA3C10-150C
10xD	D	16.180	18.415	18.602	21.103	2.688	1-1/2	Yes	HTA3D10-150F
10xD	D	16.180	18.415	18.602	21.103	2.688	1-1/2	No	HTA3D10-150C
12xD	A	19.416	21.651	21.838	24.339	2.688	1-1/2	Yes	HTA3A12-150F
12xD	A	19.416	21.651	21.838	24.339	2.688	1-1/2	No	HTA3A12-150C
12xD	B	19.416	21.651	21.838	24.339	2.688	1-1/2	Yes	HTA3B12-150F
12xD	B	19.416	21.651	21.838	24.339	2.688	1-1/2	No	HTA3B12-150C
12xD	C	19.416	21.651	21.838	24.339	2.688	1-1/2	Yes	HTA3C12-150F
12xD	C	19.416	21.651	21.838	24.339	2.688	1-1/2	No	HTA3C12-150C
12xD	D	19.416	21.651	21.838	24.339	2.688	1-1/2	Yes	HTA3D12-150F
12xD	D	19.416	21.651	21.838	24.339	2.688	1-1/2	No	HTA3D12-150C
15xD	A	24.270	26.505	26.692	29.193	2.688	1-1/2	Yes	HTA3A15-150F
15xD	A	24.270	26.505	26.692	29.193	2.688	1-1/2	No	HTA3A15-150C
15xD	B	24.270	26.505	26.692	29.193	2.688	1-1/2	Yes	HTA3B15-150F
15xD	B	24.270	26.505	26.692	29.193	2.688	1-1/2	No	HTA3B15-150C
15xD	C	24.270	26.505	26.692	29.193	2.688	1-1/2	Yes	HTA3C15-150F
15xD	C	24.270	26.505	26.692	29.193	2.688	1-1/2	No	HTA3C15-150C
15xD	D	24.270	26.505	26.692	29.193	2.688	1-1/2	Yes	HTA3D15-150F
15xD	D	24.270	26.505	26.692	29.193	2.688	1-1/2	No	HTA3D15-150C

Connection Accessories

			Admissible Tightening Torque*
Insert Screws	Nylon Locking Screws	Insert Driver	
7514-IP20-1	7514N-IP20-1	8IP-20	121.3 in-lbs (1370 N-cm)

*Tightening torques are calculated with a friction coefficient of $\mu = 0.14$ and develop 90% of ultimate yield strength

WARNING Refer to Speed and Feed charts for recommended adjustments to speeds and feeds. Refer to page A25: 68 for deep hole drilling guidelines in this section of the catalog. Visit www.alliedmachine.com/DeepHoleGuidelines for the most up-to-date information and procedures. Factory technical assistance is available for your specific applications through our Application Engineering department.
ext: 7611 | email: appeng@alliedmachine.com

A25: 58 - 65 A25: 46 - 49 A25: 50 - 53

ⓘ = Imperial (in)
Ⓜ = Metric (mm)

Screws sold in multiples of 10

A DRILLING
B BORING
C REAMING
D BURNISHING
E THREADING
F SPECIALS

T-A Pro Drill Holders

3 Series Metric | Diameter Range: 35.05 mm - 47.80 mm

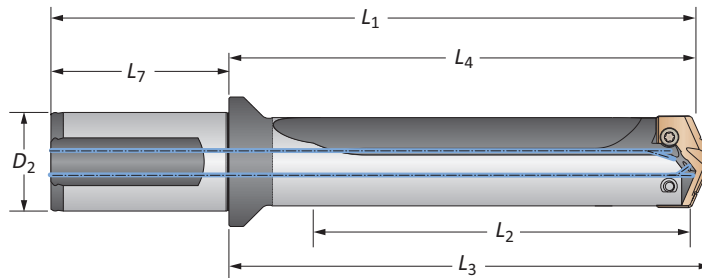

		Body				Shank			
Length	Sub Series	L ₂	L ₄	L ₃	L ₁	L ₇	D ₂	Flat	Part No
STUB	A	41.1	92.3	97.1	160.6	70.0	40	Yes	HTA3A01-40FM
STUB	A	41.1	92.3	97.1	160.6	70.0	40	No	HTA3A01-40CM
STUB	B	41.1	92.3	97.1	160.6	70.0	40	Yes	HTA3B01-40FM
STUB	B	41.1	92.3	97.1	160.6	70.0	40	No	HTA3B01-40CM
STUB	C	41.1	92.3	97.1	160.6	70.0	40	Yes	HTA3C01-40FM
STUB	C	41.1	92.3	97.1	160.6	70.0	40	No	HTA3C01-40CM
STUB	D	41.1	92.3	97.1	160.6	70.0	40	Yes	HTA3D01-40FM
STUB	D	41.1	92.3	97.1	160.6	70.0	40	No	HTA3D01-40CM
3xD	A	123.3	180.1	184.8	248.3	70.0	40	Yes	HTA3A03-40FM
3xD	A	123.3	180.1	184.8	248.3	70.0	40	No	HTA3A03-40CM
3xD	B	123.3	180.1	184.8	248.3	70.0	40	Yes	HTA3B03-40FM
3xD	B	123.3	180.1	184.8	248.3	70.0	40	No	HTA3B03-40CM
3xD	C	123.3	180.1	184.8	248.3	70.0	40	Yes	HTA3C03-40FM
3xD	C	123.3	180.1	184.8	248.3	70.0	40	No	HTA3C03-40CM
3xD	D	123.3	180.1	184.8	248.3	70.0	40	Yes	HTA3D03-40FM
3xD	D	123.3	180.1	184.8	248.3	70.0	40	No	HTA3D03-40CM
5xD	A	205.5	262.2	267.0	330.5	70.0	40	Yes	HTA3A05-40FM
5xD	A	205.5	262.2	267.0	330.5	70.0	40	No	HTA3A05-40CM
5xD	B	205.5	262.2	267.0	330.5	70.0	40	Yes	HTA3B05-40FM
5xD	B	205.5	262.2	267.0	330.5	70.0	40	No	HTA3B05-40CM
5xD	C	205.5	262.2	267.0	330.5	70.0	40	Yes	HTA3C05-40FM
5xD	C	205.5	262.2	267.0	330.5	70.0	40	No	HTA3C05-40CM
5xD	D	205.5	262.2	267.0	330.5	70.0	40	Yes	HTA3D05-40FM
5xD	D	205.5	262.2	267.0	330.5	70.0	40	No	HTA3D05-40CM
7xD	A	287.7	344.4	349.2	412.7	70.0	40	Yes	HTA3A07-40FM
7xD	A	287.7	344.4	349.2	412.7	70.0	40	No	HTA3A07-40CM
7xD	B	287.7	344.4	349.2	412.7	70.0	40	Yes	HTA3B07-40FM
7xD	B	287.7	344.4	349.2	412.7	70.0	40	No	HTA3B07-40CM
7xD	C	287.7	344.4	349.2	412.7	70.0	40	Yes	HTA3C07-40FM
7xD	C	287.7	344.4	349.2	412.7	70.0	40	No	HTA3C07-40CM
7xD	D	287.7	344.4	349.2	412.7	70.0	40	Yes	HTA3D07-40FM
7xD	D	287.7	344.4	349.2	412.7	70.0	40	No	HTA3D07-40CM

Connection Accessories

Insert Screws	Nylon Locking Screws	Insert Driver	Admissible Tightening Torque*
7514-IP20-1	7514N-IP20-1	8IP-20	121.3 in-lbs (1370 N-cm)

*Tightening torques are calculated with a friction coefficient of $\mu = 0.14$ and develop 90% of ultimate yield strength

WARNING Refer to Speed and Feed charts for recommended adjustments to speeds and feeds. Refer to page A25: 68 for deep hole drilling guidelines in this section of the catalog. Visit www.alliedmachine.com/DeepHoleGuidelines for the most up-to-date information and procedures. Factory technical assistance is available for your specific applications through our Application Engineering department.
ext: 7611 | email: appeng@alliedmachine.com

A25: 58 - 65

A25: 46 - 49

A25: 50 - 53

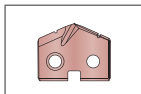
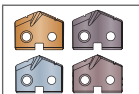
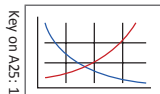

i = Imperial (in)
m = Metric (mm)

Screws sold in multiples of 10

T-A Pro Drill Holders

3 Series Metric | Diameter Range: 35.05 mm - 47.80 mm

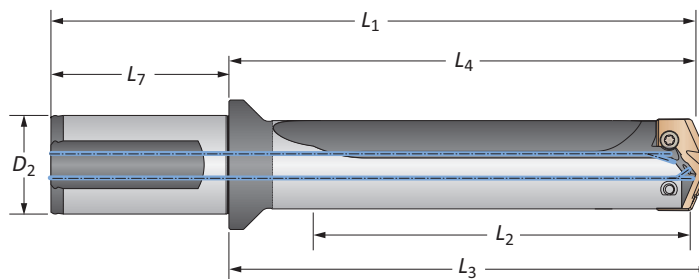

Length	Sub Series	Body				Shank			Flat	Part No
		L ₂	L ₄	L ₃	L ₁	L ₇	D ₂			
10xD	A	411.0	467.7	472.5	536.0	70.0	40	Yes	⚠ HTA3A10-40FM	
10xD	A	411.0	467.7	472.5	536.0	70.0	40	No	⚠ HTA3A10-40CM	
10xD	B	411.0	467.7	472.5	536.0	70.0	40	Yes	⚠ HTA3B10-40FM	
10xD	B	411.0	467.7	472.5	536.0	70.0	40	No	⚠ HTA3B10-40CM	
10xD	C	411.0	467.7	472.5	536.0	70.0	40	Yes	⚠ HTA3C10-40FM	
10xD	C	411.0	467.7	472.5	536.0	70.0	40	No	⚠ HTA3C10-40CM	
10xD	D	411.0	467.7	472.5	536.0	70.0	40	Yes	⚠ HTA3D10-40FM	
10xD	D	411.0	467.7	472.5	536.0	70.0	40	No	⚠ HTA3D10-40CM	
12xD	A	493.2	549.9	554.7	618.2	70.0	40	Yes	⚠ HTA3A12-40FM	
12xD	A	493.2	549.9	554.7	618.2	70.0	40	No	⚠ HTA3A12-40CM	
12xD	B	493.2	549.9	554.7	618.2	70.0	40	Yes	⚠ HTA3B12-40FM	
12xD	B	493.2	549.9	554.7	618.2	70.0	40	No	⚠ HTA3B12-40CM	
12xD	C	493.2	549.9	554.7	618.2	70.0	40	Yes	⚠ HTA3C12-40FM	
12xD	C	493.2	549.9	554.7	618.2	70.0	40	No	⚠ HTA3C12-40CM	
12xD	D	493.2	549.9	554.7	618.2	70.0	40	Yes	⚠ HTA3D12-40FM	
12xD	D	493.2	549.9	554.7	618.2	70.0	40	No	⚠ HTA3D12-40CM	
15xD	A	616.5	673.2	678.0	741.5	70.0	40	Yes	⚠ HTA3A15-40FM	
15xD	A	616.5	673.2	678.0	741.5	70.0	40	No	⚠ HTA3A15-40CM	
15xD	B	616.5	673.2	678.0	741.5	70.0	40	Yes	⚠ HTA3B15-40FM	
15xD	B	616.5	673.2	678.0	741.5	70.0	40	No	⚠ HTA3B15-40CM	
15xD	C	616.5	673.2	678.0	741.5	70.0	40	Yes	⚠ HTA3C15-40FM	
15xD	C	616.5	673.2	678.0	741.5	70.0	40	No	⚠ HTA3C15-40CM	
15xD	D	616.5	673.2	678.0	741.5	70.0	40	Yes	⚠ HTA3D15-40FM	
15xD	D	616.5	673.2	678.0	741.5	70.0	40	No	⚠ HTA3D15-40CM	

Connection Accessories

			Admissible Tightening Torque*
Insert Screws	Nylon Locking Screws	Insert Driver	
7514-IP20-1	7514N-IP20-1	8IP-20	121.3 in-lbs (1370 N-cm)

*Tightening torques are calculated with a friction coefficient of $\mu = 0.14$ and develop 90% of ultimate yield strength

⚠ WARNING Refer to Speed and Feed charts for recommended adjustments to speeds and feeds. Refer to page A25: 68 for deep hole drilling guidelines in this section of the catalog. Visit www.alliedmachine.com/DeepHoleGuidelines for the most up-to-date information and procedures. Factory technical assistance is available for your specific applications through our Application Engineering department.
ext: 7611 | email: appeng@alliedmachine.com

A25: 58 - 65 A25: 46 - 49 A25: 50 - 53

ⓘ = Imperial (in)
Ⓜ = Metric (mm)

Screws sold in multiples of 10

Carbide Recommended Drilling Data | Imperial (inch)

Material	Hardness (BHN)	Insert Grade	Speed (SFM)	Feed Rate (IPR) by Diameter					
				3/8" - 33/64"	1/2" - 11/16"	45/64" - 15/16"	31/32" - 1-3/8"	1-13/32" - 1-7/8"	
P Free-Machining Steel 1118, 1215, 12L14, etc.	100 - 150	P	475	0.007	0.010	0.013	0.016	0.020	
	150 - 200	P	440	0.007	0.010	0.013	0.016	0.020	
	200 - 250	P	410	0.006	0.010	0.013	0.016	0.020	
	Low-Carbon Steel 1010, 1020, 1025, 1522, 1144, etc.	85 - 125	P	425	0.006	0.009	0.012	0.015	0.019
		125 - 175	P	410	0.006	0.009	0.012	0.015	0.019
		175 - 225	P	385	0.005	0.008	0.010	0.014	0.018
	Medium-Carbon Steel 1030, 1040, 1050, 1527, 1140, 1151, etc.	225 - 275	P	355	0.005	0.008	0.010	0.014	0.018
		125 - 175	P	410	0.006	0.009	0.012	0.015	0.019
		175 - 225	P	385	0.005	0.008	0.010	0.014	0.018
	Alloy Steel 4140, 5140, 8640, etc.	225 - 275	P	355	0.005	0.008	0.010	0.014	0.018
		275 - 325	P	330	0.004	0.007	0.009	0.012	0.016
		125 - 175	P	420	0.006	0.009	0.012	0.014	0.017
175 - 225		P	390	0.005	0.008	0.011	0.014	0.017	
High-Strength Alloy 4340, 4330V, 300M, etc.	225 - 275	P	360	0.005	0.008	0.011	0.014	0.017	
	275 - 325	P	340	0.004	0.007	0.010	0.012	0.015	
	325 - 375	P	310	0.003	0.007	0.010	0.012	0.015	
Structural Steel A36, A285, A516, etc.	225 - 300	P	350	0.004	0.007	0.010	0.013	0.015	
	300 - 350	P	325	0.003	0.006	0.009	0.012	0.014	
	350 - 400	P	300	0.003	0.006	0.008	0.011	0.013	
Tool Steel H-13, H-21, A-4, S-3, etc.	100 - 150	P	400	0.006	0.010	0.012	0.014	0.018	
	150 - 250	P	340	0.005	0.009	0.010	0.012	0.016	
	250 - 350	P	280	0.004	0.008	0.009	0.010	0.014	
S High-Temp Alloy Hastelloy B, Inconel 600, etc.	150 - 200	P	220	0.004	0.006	0.008	0.010	0.012	
	200 - 250	P	180	0.004	0.006	0.008	0.010	0.012	
	140 - 220	M	110	0.002	0.005	0.007	0.008	0.009	
	220 - 310	M	85	0.002	0.003	0.005	0.006	0.007	
	Titanium Alloy	140 - 220	M	150	0.003	0.004	0.007	0.008	0.009
		220 - 310	M	120	0.003	0.003	0.005	0.006	0.007
Aerospace Alloy S82	185 - 275	M	150	0.003	0.004	0.007	0.008	0.009	
	275 - 350	M	120	0.003	0.003	0.005	0.006	0.007	

7xD and 10xD Adjustment Example (0.80 Adjustment)

Data • Adjustment Value	Speed/Feed (7xD)
200 SFM • 0.80	= 160 SFM
0.008 IPR • 0.80	= 0.0064 IPR

12xD and 15xD Adjustment Example (0.70 Adjustment)

Speed • Adjustment Value	Speed/Feed (12xD)
200 SFM • 0.70	= 140 SFM
0.008 IPR • 0.70	= 0.0056 IPR

Coolant Recommendations

Series	STUB, 3xD, 5xD		7xD, 10xD		12xD, 15xD	
	Pressure PSI	Flow Rate GPM	Pressure PSI	Flow Rate GPM	Pressure PSI	Flow Rate GPM
Z	450	4	550	6	650	8
0	350	6	450	9	550	12
1	300	8	400	10	500	12
2	250	10	350	13	450	16
3	200	12	300	14	400	18

⚠ WARNING Tool failure can cause serious injury. To prevent:

- When using holders without support bushing, use a short T-A Pro holder to establish an initial hole that is a minimum of 2 diameters deep.
- Do not rotate tool holders more than 50 RPM unless it is engaged with the workpiece or fixture.

Visit www.alliedmachine.com/DeepHoleGuidelines for the most up-to-date information and procedures.

Factory technical assistance is available for your specific applications through our Application Engineering department. ext: 7611 | email: appeng@alliedmachine.com

IMPORTANT: The speeds and feeds listed above are a general starting point for all applications. Refer to the coolant recommendation chart for coolant requirements to run at the recommended speeds and feeds. Factory technical assistance is available through our Application Engineering department. For 7xD, 10xD, 12xD, and 15xD holder lengths, see adjustment example above.

Carbide Recommended Drilling Data | Imperial (inch)

Material	Hardness (BHN)	Insert Grade	Speed (SFM)	Feed Rate (IPR) by Diameter					
				3/8" - 33/64"	1/2" - 11/16"	45/64" - 15/16"	31/32" - 1-3/8"	1-13/32" - 1-7/8"	
M Stainless Steel 400 Series 416, 420, etc.	185 - 275	M	280	0.005	0.010	0.011	0.012	0.013	
	275 - 350	M	230	0.004	0.009	0.010	0.011	0.012	
	Stainless Steel 300 Series 304, 316, 17-4PH, etc.	135 - 185	M	280	0.003	0.004	0.005	0.008	0.011
		185 - 275	M	250	0.002	0.003	0.004	0.007	0.009
	Stainless Steel 300L Series 304L, 316L, etc.	135 - 185	M	325	0.003	0.004	0.005	0.008	0.011
		185 - 275	M	280	0.002	0.003	0.004	0.007	0.009
	PH Stainless 17-4, 13-8, 15-5	275-350	M	280	0.003	0.004	0.005	0.008	0.011
		350-425	M	250	0.002	0.003	0.004	0.007	0.009
Super Duplex Stainless Steel	135 - 185	M	250	0.003	0.004	0.005	0.008	0.011	
	185 - 275	M	230	0.002	0.003	0.004	0.007	0.009	
H Wear Plate Hardox®, AR400, T-1, etc.	400	P	70	0.003	0.006	0.008	0.009	0.012	
	500	P	45	0.002	0.005	0.007	0.008	0.010	
	600	-	-	-	-	-	-	-	
	Hardened Steel	300 - 400	P	95	0.003	0.006	0.008	0.009	0.012
400 - 500		P	45	0.002	0.005	0.007	0.008	0.010	
K SG / Nodular Cast Iron	120 - 150	K	600	0.007	0.012	0.016	0.020	0.024	
	150 - 200	K	550	0.006	0.011	0.014	0.018	0.022	
	200 - 220	K	500	0.006	0.009	0.012	0.016	0.018	
	220 - 260	K	450	0.005	0.007	0.009	0.012	0.014	
	260 - 320	K	400	0.004	0.006	0.007	0.009	0.012	
N Cast Aluminum	30	N	1100	0.008	0.013	0.016	0.020	0.022	
	180	N	600	0.008	0.013	0.016	0.018	0.022	
	Wrought Aluminum	30	N	1100	0.009	0.013	0.017	0.020	0.024
		180	N	600	0.005	0.007	0.010	0.013	0.016
	Aluminum Bronze	100 - 200	N	500	0.006	0.011	0.014	0.018	0.022
		200 - 250	N	300	0.005	0.007	0.009	0.012	0.014
	Brass	100	N	650	0.007	0.012	0.016	0.020	0.024
Copper	60	N	430	0.002	0.003	0.006	0.008	0.010	

7xD and 10xD Adjustment Example (0.80 Adjustment)

Data • Adjustment Value	Speed/Feed (7xD)
200 SFM • 0.80	= 160 SFM
0.008 IPR • 0.80	= 0.0064 IPR

12xD and 15xD Adjustment Example (0.70 Adjustment)

Speed • Adjustment Value	Speed/Feed (12xD)
200 SFM • 0.70	= 140 SFM
0.008 IPR • 0.70	= 0.0056 IPR

Coolant Recommendations

Series	STUB, 3xD, 5xD		7xD, 10xD		12xD, 15xD	
	Pressure PSI	Flow Rate GPM	Pressure PSI	Flow Rate GPM	Pressure PSI	Flow Rate GPM
Z	450	4	550	6	650	8
0	350	6	450	9	550	12
1	300	8	400	10	500	12
2	250	10	350	13	450	16
3	200	12	300	14	400	18

⚠ WARNING Tool failure can cause serious injury. To prevent:

- When using holders without support bushing, use a short T-A Pro holder to establish an initial hole that is a minimum of 2 diameters deep.
- Do not rotate tool holders more than 50 RPM unless it is engaged with the workpiece or fixture.

Visit www.alliedmachine.com/DeepHoleGuidelines for the most up-to-date information and procedures.
 Factory technical assistance is available for your specific applications through our Application Engineering department. ext: 7611 | email: appeng@alliedmachine.com

IMPORTANT: The speeds and feeds listed above are a general starting point for all applications. Refer to the coolant recommendation chart for coolant requirements to run at the recommended speeds and feeds. Factory technical assistance is available through our Application Engineering department. For 7xD, 10xD, 12xD, and 15xD holder lengths, see adjustment example above.

A
DRILLING
B
BORING
C
REAMING
D
BURNISHING
E
THREADING
X
SPECIALS

High-Speed Steel Recommended Drilling Data | Imperial (inch)

Material	Hardness (BHN)	Insert Grade	Speed (SFM)	Feed Rate (IPR) by Diameter				
				3/8" - 33/64"	1/2" - 11/16"	45/64" - 15/16"	31/32" - 1-3/8"	1-13/32" - 1-7/8"
Free-Machining Steel 1118, 1215, 12L14, etc.	100 - 150	X	350	0.007	0.010	0.013	0.016	0.020
	150 - 200	X	325	0.007	0.010	0.013	0.016	0.020
	200 - 250	X	300	0.006	0.010	0.013	0.016	0.020
Low-Carbon Steel 1010, 1020, 1025, 1522, 1144, etc.	85 - 125	X	315	0.006	0.009	0.012	0.015	0.019
	125 - 175	X	300	0.006	0.009	0.012	0.015	0.019
	175 - 225	X	285	0.005	0.008	0.010	0.014	0.018
Medium-Carbon Steel 1030, 1040, 1050, 1527, 1140, 1151, etc.	225 - 275	X	265	0.005	0.008	0.010	0.014	0.018
	125 - 175	X	300	0.006	0.009	0.012	0.015	0.019
	175 - 225	X	285	0.005	0.008	0.010	0.014	0.018
Alloy Steel 4140, 5140, 8640, etc.	225 - 275	X	265	0.005	0.008	0.010	0.014	0.018
	275 - 325	X	235	0.004	0.007	0.009	0.012	0.016
	125 - 175	X	250	0.006	0.009	0.012	0.014	0.017
High-Strength Alloy 4340, 4330V, 300M, etc.	175 - 225	X	235	0.005	0.008	0.011	0.014	0.017
	225 - 275	X	220	0.005	0.008	0.011	0.014	0.017
	275 - 325	X	205	0.004	0.007	0.010	0.012	0.015
	325 - 375	X	190	0.003	0.007	0.010	0.012	0.015
Structural Steel A36, A285, A516, etc.	225 - 300	X	135	0.004	0.007	0.010	0.013	0.015
	300 - 350	X	110	0.003	0.006	0.009	0.012	0.014
	350 - 400	X	90	0.003	0.006	0.008	0.011	0.013
Tool Steel H-13, H-21, A-4, S-3, etc.	100 - 150	X	250	0.006	0.010	0.012	0.014	0.018
	150 - 250	X	210	0.005	0.009	0.010	0.012	0.016
	250 - 350	X	175	0.004	0.008	0.009	0.010	0.014
High-Temp Alloy Hastelloy B, Inconel 600, etc.	150 - 200	X	145	0.004	0.006	0.008	0.010	0.012
	200 - 250	X	120	0.004	0.006	0.008	0.010	0.012
Titanium Alloy	140 - 220	X	45	0.003	0.007	0.008	0.010	0.012
	220 - 310	X	40	0.003	0.006	0.007	0.008	0.010
	140 - 220	X	60	0.003	0.007	0.008	0.010	0.012
	220 - 310	X	50	0.003	0.006	0.007	0.008	0.010
Aerospace Alloy S82	185 - 275	X	125	0.005	0.008	0.009	0.010	0.014
	275 - 350	X	110	0.004	0.007	0.008	0.008	0.012

7xD and 10xD Adjustment Example (0.80 Adjustment)

Data • Adjustment Value	Speed/Feed (7xD)
200 SFM • 0.80	= 160 SFM
0.008 IPR • 0.80	= 0.0064 IPR

12xD and 15xD Adjustment Example (0.70 Adjustment)

Speed • Adjustment Value	Speed/Feed (12xD)
200 SFM • 0.70	= 140 SFM
0.008 IPR • 0.70	= 0.0056 IPR

Coolant Recommendations

Series	STUB, 3xD, 5xD		7xD, 10xD		12xD, 15xD	
	Pressure PSI	Flow Rate GPM	Pressure PSI	Flow Rate GPM	Pressure PSI	Flow Rate GPM
Z	450	4	550	6	650	8
0	350	6	450	9	550	12
1	300	8	400	10	500	12
2	250	10	350	13	450	16
3	200	12	300	14	400	18

⚠ WARNING Tool failure can cause serious injury. To prevent:

- When using holders without support bushing, use a short T-A Pro holder to establish an initial hole that is a minimum of 2 diameters deep.
- Do not rotate tool holders more than 50 RPM unless it is engaged with the workpiece or fixture.

Visit www.alliedmachine.com/DeepHoleGuidelines for the most up-to-date information and procedures.

Factory technical assistance is available for your specific applications through our Application Engineering department. ext: 7611 | email: appeng@alliedmachine.com

IMPORTANT: The speeds and feeds listed above are a general starting point for all applications. Refer to the coolant recommendation chart for coolant requirements to run at the recommended speeds and feeds. Factory technical assistance is available through our Application Engineering department. For 7xD, 10xD, 12xD, and 15xD holder lengths, see adjustment example above.

High-Speed Steel Recommended Drilling Data | Imperial (inch)

Material	Hardness (BHN)	Insert Grade	Speed (SFM)	Feed Rate (IPR) by Diameter					
				3/8" - 33/64"	1/2" - 11/16"	45/64" - 15/16"	31/32" - 1-3/8"	1-13/32" - 1-7/8"	
M Stainless Steel 400 Series 416, 420, etc.	185 - 275	X	125	0.005	0.010	0.011	0.012	0.013	
	275 - 350	X	110	0.004	0.009	0.010	0.011	0.012	
	Stainless Steel 300 Series 304, 316, 17-4PH, etc.	135 - 185	X	125	0.005	0.007	0.008	0.009	0.012
		185 - 275	X	110	0.004	0.006	0.007	0.008	0.011
	PH Stainless 17-4, 13-8, 15-5	275-350	X	95	0.003	0.004	0.006	0.008	0.010
		350-425	X	75	0.003	0.004	0.006	0.008	0.010
Super Duplex Stainless Steel	135 - 185	X	125	0.005	0.005	0.006	0.006	0.007	
	185 - 275	X	110	0.004	0.005	0.005	0.006	0.006	
H Wear Plate Hardox®, AR400, T-1, etc.	400	X	60	0.003	0.006	0.008	0.009	0.012	
	500	X	45	0.002	0.005	0.007	0.008	0.010	
	600	-	-	-	-	-	-	-	
	Hardened Steel	300 - 400	X	75	0.003	0.006	0.008	0.009	0.012
400 - 500		X	45	0.002	0.005	0.007	0.008	0.010	
K SG / Nodular Cast Iron	120 - 150	X	300	0.007	0.012	0.016	0.020	0.024	
	150 - 200	X	275	0.006	0.011	0.014	0.018	0.022	
	200 - 220	X	240	0.006	0.009	0.012	0.016	0.018	
	220 - 260	X	215	0.005	0.007	0.009	0.012	0.014	
	260 - 320	X	175	0.004	0.006	0.007	0.009	0.012	
N Cast Aluminum	30	X	600	0.008	0.013	0.016	0.020	0.022	
	180	X	300	0.008	0.013	0.016	0.018	0.022	
	Wrought Aluminum	30	X	900	0.009	0.013	0.017	0.020	0.024
		180	X	600	0.005	0.007	0.010	0.013	0.016
	Aluminum Bronze	100 - 200	X	300	0.006	0.011	0.014	0.018	0.022
		200 - 250	X	250	0.005	0.007	0.009	0.012	0.014
Brass	100	X	485	0.007	0.012	0.016	0.020	0.024	
Copper	60	X	320	0.002	0.003	0.006	0.008	0.010	

7xD and 10xD Adjustment Example (0.80 Adjustment)

Data • Adjustment Value	Speed/Feed (7xD)
200 SFM • 0.80	= 160 SFM
0.008 IPR • 0.80	= 0.0064 IPR

12xD and 15xD Adjustment Example (0.70 Adjustment)

Speed • Adjustment Value	Speed/Feed (12xD)
200 SFM • 0.70	= 140 SFM
0.008 IPR • 0.70	= 0.0056 IPR

Coolant Recommendations

Series	STUB, 3xD, 5xD		7xD, 10xD		12xD, 15xD	
	Pressure PSI	Flow Rate GPM	Pressure PSI	Flow Rate GPM	Pressure PSI	Flow Rate GPM
Z	450	4	550	6	650	8
0	350	6	450	9	550	12
1	300	8	400	10	500	12
2	250	10	350	13	450	16
3	200	12	300	14	400	18

⚠ WARNING Tool failure can cause serious injury. To prevent:

- When using holders without support bushing, use a short T-A Pro holder to establish an initial hole that is a minimum of 2 diameters deep.
- Do not rotate tool holders more than 50 RPM unless it is engaged with the workpiece or fixture.

Visit www.alliedmachine.com/DeepHoleGuidelines for the most up-to-date information and procedures.
 Factory technical assistance is available for your specific applications through our Application Engineering department. ext: 7611 | email: appeng@alliedmachine.com

IMPORTANT: The speeds and feeds listed above are a general starting point for all applications. Refer to the coolant recommendation chart for coolant requirements to run at the recommended speeds and feeds. Factory technical assistance is available through our Application Engineering department. For 7xD, 10xD, 12xD, and 15xD holder lengths, see adjustment example above.

A
DRILLING
B
BORING
C
REAMING
D
BURNISHING
E
THREADING
X
SPECIALS

Carbide Recommended Drilling Data | Metric (mm)

Material	Hardness (BHN)	Insert Grade	Speed (M/min)	Feed Rate (mm/rev) by Diameter					
				9.50 mm - 12.69 mm	12.70 mm - 17.64 mm	17.65 mm - 24.37 mm	24.38 mm - 35.04 mm	35.05 mm - 47.80 mm	
P Free-Machining Steel 1118, 1215, 12L14, etc.	100 - 150	P	145	0.18	0.25	0.33	0.410	0.51	
	150 - 200	P	135	0.18	0.25	0.33	0.41	0.51	
	200 - 250	P	125	0.15	0.25	0.33	0.41	0.51	
	Low-Carbon Steel 1010, 1020, 1025, 1522, 1144, etc.	85 - 125	P	130	0.15	0.23	0.30	0.38	0.48
		125 - 175	P	125	0.15	0.23	0.30	0.38	0.48
		175 - 225	P	115	0.13	0.20	0.25	0.36	0.46
	Medium-Carbon Steel 1030, 1040, 1050, 1527, 1140, 1151, etc.	225 - 275	P	110	0.13	0.20	0.25	0.36	0.46
		125 - 175	P	125	0.15	0.23	0.30	0.38	0.48
		175 - 225	P	115	0.13	0.20	0.25	0.36	0.46
	Alloy Steel 4140, 5140, 8640, etc.	225 - 275	P	110	0.13	0.20	0.25	0.36	0.46
		275 - 325	P	100	0.10	0.18	0.23	0.30	0.41
		125 - 175	P	130	0.15	0.23	0.30	0.36	0.43
175 - 225		P	120	0.13	0.20	0.28	0.36	0.43	
High-Strength Alloy 4340, 4330V, 300M, etc.	225 - 275	P	110	0.13	0.20	0.28	0.36	0.43	
	275 - 325	P	105	0.10	0.18	0.25	0.30	0.38	
	325 - 375	P	95	0.08	0.18	0.25	0.30	0.38	
Structural Steel A36, A285, A516, etc.	225 - 300	P	105	0.10	0.18	0.25	0.33	0.38	
	300 - 350	P	100	0.08	0.15	0.23	0.30	0.36	
	350 - 400	P	90	0.08	0.15	0.20	0.28	0.33	
Tool Steel H-13, H-21, A-4, S-3, etc.	100 - 150	P	120	0.15	0.25	0.30	0.36	0.46	
	150 - 250	P	105	0.13	0.23	0.25	0.30	0.41	
	250 - 350	P	85	0.10	0.20	0.23	0.25	0.36	
S High-Temp Alloy Hastelloy B, Inconel 600, etc.	150 - 200	P	65	0.10	0.15	0.20	0.25	0.30	
	200 - 250	P	55	0.10	0.15	0.20	0.25	0.30	
	140 - 220	M	33	0.05	0.13	0.18	0.20	0.23	
	220 - 310	M	26	0.05	0.08	0.13	0.15	0.18	
	Titanium Alloy	140 - 220	M	45	0.08	0.10	0.18	0.20	0.23
		220 - 310	M	36	0.08	0.08	0.13	0.15	0.18
Aerospace Alloy S82	185 - 275	M	45	0.08	0.10	0.18	0.20	0.23	
	275 - 350	M	36	0.08	0.08	0.13	0.15	0.18	

7xD and 10xD Adjustment Example (0.80 Adjustment)

Data • Adjustment Value	Speed/Feed (7xD)
100 M/min • 0.80	= 80 M/min
0.2 mm/rev • 0.80	= 0.16 mm/rev

12xD and 15xD Adjustment Example (0.70 Adjustment)

Speed • Adjustment Value	Speed/Feed (12xD)
100 M/min • 0.70	= 70 M/min
0.2 mm/rev • 0.70	= 0.14 mm/rev

Coolant Recommendations

Series	STUB, 3xD, 5xD		7xD, 10xD		12xD, 15xD	
	Pressure BAR	Flow Rate LPM	Pressure BAR	Flow Rate LPM	Pressure BAR	Flow Rate LPM
Z	31	15	34	22	45	30
0	24	22	31	34	34	45
1	21	30	27	38	34	45
2	17	38	24	49	31	60
3	14	45	21	53	27	68

⚠ WARNING Tool failure can cause serious injury. To prevent:

- When using holders without support bushing, use a short T-A Pro holder to establish an initial hole that is a minimum of 2 diameters deep.
- Do not rotate tool holders more than 50 RPM unless it is engaged with the workpiece or fixture.

Visit www.alliedmachine.com/DeepHoleGuidelines for the most up-to-date information and procedures.

Factory technical assistance is available for your specific applications through our Application Engineering department. ext: 7611 | email: appeng@alliedmachine.com

IMPORTANT: The speeds and feeds listed above are a general starting point for all applications. Refer to the coolant recommendation chart for coolant requirements to run at the recommended speeds and feeds. Factory technical assistance is available through our Application Engineering department. For 7xD, 10xD, 12xD, and 15xD holder lengths, see adjustment example above.

Carbide Recommended Drilling Data | Metric (mm)

Material	Hardness (BHN)	Insert Grade	Speed (M/min)	Feed Rate (mm/rev) by Diameter					
				9.50 mm - 12.69 mm	12.70 mm - 17.64 mm	17.65 mm - 24.37 mm	24.38 mm - 35.04 mm	35.05 mm - 47.80 mm	
M Stainless Steel 400 Series 416, 420, etc.	185 - 275	M	85	0.13	0.25	0.28	0.30	0.33	
	275 - 350	M	75	0.10	0.23	0.25	0.28	0.30	
	Stainless Steel 300 Series 304, 316, 17-4PH, etc.	135 - 185	M	85	0.08	0.10	0.13	0.20	0.28
		185 - 275	M	75	0.05	0.08	0.10	0.18	0.23
	Stainless Steel 300L Series 304L, 316L etc.	135 - 185	M	100	0.08	0.10	0.13	0.20	0.28
		185 - 275	M	85	0.05	0.08	0.10	0.18	0.23
	PH Stainless 17-4, 13-8, 15-5	275-350	M	85	0.08	0.10	0.13	0.20	0.28
		350-425	M	75	0.05	0.08	0.10	0.18	0.23
Super Duplex Stainless Steel	135 - 185	M	75	0.08	0.10	0.13	0.20	0.28	
	185 - 275	M	70	0.05	0.08	0.10	0.18	0.23	
H Wear Plate Hardox®, AR400, T-1, etc.	400	P	20	0.08	0.15	0.20	0.23	0.30	
	500	P	15	0.05	0.13	0.18	0.20	0.25	
	600	-	-	-	-	-	-	-	
	Hardened Steel	300 - 400	P	30	0.08	0.15	0.20	0.23	0.30
400 - 500		P	15	0.05	0.13	0.18	0.20	0.25	
K SG / Nodular Cast Iron	120 - 150	K	185	0.18	0.30	0.41	0.51	0.61	
	150 - 200	K	170	0.15	0.28	0.36	0.46	0.56	
	200 - 220	K	150	0.15	0.23	0.30	0.41	0.46	
	220 - 260	K	135	0.13	0.18	0.23	0.30	0.36	
	260 - 320	K	120	0.10	0.15	0.18	0.23	0.30	
N Cast Aluminum	30	N	335	0.20	0.33	0.41	0.51	0.56	
	180	N	185	0.20	0.33	0.41	0.46	0.56	
	Wrought Aluminum	30	N	335	0.23	0.33	0.43	0.51	0.61
		180	N	185	0.13	0.18	0.25	0.33	0.41
	Aluminum Bronze	100 - 200	N	150	0.15	0.28	0.36	0.46	0.56
		200 - 250	N	90	0.13	0.18	0.23	0.30	0.36
	Brass	100	N	200	0.18	0.30	0.41	0.51	0.61
Copper	60	N	130	0.05	0.08	0.15	0.20	0.25	

7xD and 10xD Adjustment Example (0.80 Adjustment)

Data • Adjustment Value	Speed/Feed (7xD)
100 M/min • 0.80	= 80 M/min
0.2 mm/rev • 0.80	= 0.16 mm/rev

12xD and 15xD Adjustment Example (0.70 Adjustment)

Speed • Adjustment Value	Speed/Feed (12xD)
100 M/min • 0.70	= 70 M/min
0.2 mm/rev • 0.70	= 0.14 mm/rev

Coolant Recommendations

Series	STUB, 3xD, 5xD		7xD, 10xD		12xD, 15xD	
	Pressure BAR	Flow Rate LPM	Pressure BAR	Flow Rate LPM	Pressure BAR	Flow Rate LPM
Z	31	15	34	22	45	30
0	24	22	31	34	34	45
1	21	30	27	38	34	45
2	17	38	24	49	31	60
3	14	45	21	53	27	68

⚠ WARNING Tool failure can cause serious injury. To prevent:

- When using holders without support bushing, use a short T-A Pro holder to establish an initial hole that is a minimum of 2 diameters deep.
- Do not rotate tool holders more than 50 RPM unless it is engaged with the workpiece or fixture.

Visit www.alliedmachine.com/DeepHoleGuidelines for the most up-to-date information and procedures.
 Factory technical assistance is available for your specific applications through our Application Engineering department. ext: 7611 | email: appeng@alliedmachine.com

IMPORTANT: The speeds and feeds listed above are a general starting point for all applications. Refer to the coolant recommendation chart for coolant requirements to run at the recommended speeds and feeds. Factory technical assistance is available through our Application Engineering department. For 7xD, 10xD, 12xD, and 15xD holder lengths, see adjustment example above.

A
DRILLING
B
BORING
C
REAMING
D
BURNISHING
E
THREADING
X
SPECIALS

High-Speed Steel Recommended Drilling Data | Metric (mm)

Material	Hardness (BHN)	Insert Grade	Speed (M/min)	Feed Rate (mm/rev) by Diameter					
				9.50 mm - 12.69 mm	12.70 mm - 17.64 mm	17.65 mm - 24.37 mm	24.38 mm - 35.04 mm	35.05 mm - 47.80 mm	
P Free-Machining Steel 1118, 1215, 12L14, etc.	100 - 150	X	105	0.18	0.25	0.33	0.41	0.51	
	150 - 200	X	100	0.18	0.25	0.33	0.41	0.51	
	200 - 250	X	90	0.15	0.25	0.33	0.41	0.51	
	Low-Carbon Steel 1010, 1020, 1025, 1522, 1144, etc.	85 - 125	X	95	0.15	0.23	0.30	0.38	0.48
		125 - 175	X	90	0.15	0.23	0.30	0.38	0.48
		175 - 225	X	85	0.13	0.20	0.25	0.36	0.46
	Medium-Carbon Steel 1030, 1040, 1050, 1527, 1140, 1151, etc.	225 - 275	X	80	0.13	0.20	0.25	0.36	0.46
		125 - 175	X	90	0.15	0.23	0.30	0.38	0.48
		175 - 225	X	85	0.13	0.20	0.25	0.36	0.46
	Alloy Steel 4140, 5140, 8640, etc.	225 - 275	X	80	0.13	0.20	0.25	0.36	0.46
		275 - 325	X	70	0.10	0.18	0.23	0.30	0.41
		125 - 175	X	75	0.15	0.23	0.30	0.36	0.43
175 - 225		X	70	0.13	0.20	0.28	0.36	0.43	
High-Strength Alloy 4340, 4330V, 300M, etc.	225 - 275	X	65	0.13	0.20	0.28	0.36	0.43	
	275 - 325	X	60	0.10	0.18	0.25	0.30	0.38	
	325 - 375	X	60	0.08	0.18	0.25	0.30	0.38	
	225 - 300	X	40	0.10	0.18	0.25	0.33	0.38	
Structural Steel A36, A285, A516, etc.	300 - 350	X	35	0.08	0.15	0.23	0.30	0.36	
	350 - 400	X	25	0.08	0.15	0.20	0.28	0.33	
	100 - 150	X	75	0.15	0.25	0.30	0.36	0.46	
Tool Steel H-13, H-21, A-4, S-3, etc.	150 - 250	X	65	0.13	0.23	0.25	0.30	0.41	
	250 - 350	X	55	0.10	0.20	0.23	0.25	0.36	
S High-Temp Alloy Hastelloy B, Inconel 600, etc.	150 - 200	X	45	0.10	0.15	0.20	0.25	0.30	
	200 - 250	X	35	0.10	0.15	0.20	0.25	0.30	
	140 - 220	X	15	0.08	0.18	0.20	0.25	0.30	
	220 - 310	X	10	0.08	0.15	0.18	0.20	0.25	
	Titanium Alloy	140 - 220	X	20	0.08	0.18	0.20	0.25	0.30
		220 - 310	X	15	0.08	0.15	0.18	0.20	0.25
	Aerospace Alloy S82	185 - 275	X	40	0.13	0.20	0.23	0.25	0.36
		275 - 350	X	35	0.10	0.18	0.20	0.20	0.30

7xD and 10xD Adjustment Example (0.80 Adjustment)

Data • Adjustment Value	Speed/Feed (7xD)
100 M/min • 0.80	= 80 M/min
0.2 mm/rev • 0.80	= 0.16 mm/rev

12xD and 15xD Adjustment Example (0.70 Adjustment)

Speed • Adjustment Value	Speed/Feed (12xD)
100 M/min • 0.70	= 70 M/min
0.2 mm/rev • 0.70	= 0.14 mm/rev

Coolant Recommendations

Series	STUB, 3xD, 5xD		7xD, 10xD		12xD, 15xD	
	Pressure BAR	Flow Rate LPM	Pressure BAR	Flow Rate LPM	Pressure BAR	Flow Rate LPM
Z	31	15	34	22	45	30
0	24	22	31	34	34	45
1	21	30	27	38	34	45
2	17	38	24	49	31	60
3	14	45	21	53	27	68

⚠ WARNING Tool failure can cause serious injury. To prevent:

- When using holders without support bushing, use a short T-A Pro holder to establish an initial hole that is a minimum of 2 diameters deep.
- Do not rotate tool holders more than 50 RPM unless it is engaged with the workpiece or fixture.

Visit www.alliedmachine.com/DeepHoleGuidelines for the most up-to-date information and procedures.

Factory technical assistance is available for your specific applications through our Application Engineering department. ext: 7611 | email: appeng@alliedmachine.com

IMPORTANT: The speeds and feeds listed above are a general starting point for all applications. Refer to the coolant recommendation chart for coolant requirements to run at the recommended speeds and feeds. Factory technical assistance is available through our Application Engineering department. For 7xD, 10xD, 12xD, and 15xD holder lengths, see adjustment example above.

High-Speed Steel Recommended Drilling Data | Metric (mm)

Material	Hardness (BHN)	Insert Grade	Speed (M/min)	Feed Rate (mm/rev) by Diameter					
				9.50 mm - 12.69 mm	12.70 mm - 17.64 mm	17.65 mm - 24.37 mm	24.38 mm - 35.04 mm	35.05 mm - 47.80 mm	
M Stainless Steel 400 Series 416, 420, etc.	185 - 275	X	40	0.13	0.25	0.28	0.30	0.33	
	275 - 350	X	35	0.10	0.23	0.25	0.28	0.30	
	Stainless Steel 300 Series 304, 316, 17-4PH, etc.	135 - 185	X	40	0.13	0.18	0.20	0.23	0.30
		185 - 275	X	35	0.10	0.15	0.18	0.20	0.28
	PH Stainless 17-4, 13-8, 15-5	275-350	X	30	0.08	0.10	0.15	0.20	0.25
		350-425	X	25	0.08	0.10	0.15	0.20	0.25
Super Duplex Stainless Steel	135 - 185	X	40	0.13	0.13	0.15	0.15	0.18	
	185 - 275	X	35	0.10	0.13	0.13	0.15	0.15	
H Wear Plate Hardox®, AR400, T-1, etc.	400	X	20	0.08	0.15	0.20	0.23	0.30	
	500	X	15	0.05	0.13	0.18	0.20	0.25	
	600	-	-	-	-	-	-	-	
	Hardened Steel	300 - 400	X	30	0.08	0.15	0.20	0.23	0.30
400 - 500		X	15	0.05	0.13	0.18	0.20	0.25	
K SG / Nodular Cast Iron	120 - 150	X	90	0.18	0.30	0.41	0.51	0.61	
	150 - 200	X	85	0.15	0.28	0.36	0.46	0.56	
	200 - 220	X	75	0.15	0.23	0.30	0.41	0.46	
	220 - 260	X	65	0.13	0.18	0.23	0.30	0.36	
	260 - 320	X	55	0.10	0.15	0.18	0.23	0.30	
N Cast Aluminum	30	X	185	0.20	0.33	0.41	0.51	0.56	
	180	X	90	0.20	0.33	0.41	0.46	0.56	
	Wrought Aluminum	30	X	275	0.23	0.33	0.43	0.51	0.61
		180	X	185	0.13	0.18	0.25	0.33	0.41
	Aluminum Bronze	100 - 200	X	90	0.15	0.28	0.36	0.46	0.56
		200 - 250	X	75	0.13	0.18	0.23	0.30	0.36
	Brass	100	X	150	0.18	0.30	0.41	0.51	0.61
Copper	60	X	100	0.05	0.08	0.15	0.20	0.25	

7xD and 10xD Adjustment Example (0.80 Adjustment)

Data • Adjustment Value	Speed/Feed (7xD)
100 M/min • 0.80	= 80 M/min
0.2 mm/rev • 0.80	= 0.16 mm/rev

12xD and 15xD Adjustment Example (0.70 Adjustment)

Speed • Adjustment Value	Speed/Feed (12xD)
100 M/min • 0.70	= 70 M/min
0.2 mm/rev • 0.70	= 0.14 mm/rev

Coolant Recommendations

Series	STUB, 3xD, 5xD		7xD, 10xD		12xD, 15xD	
	Pressure BAR	Flow Rate LPM	Pressure BAR	Flow Rate LPM	Pressure BAR	Flow Rate LPM
Z	31	15	34	22	45	30
0	24	22	31	34	34	45
1	21	30	27	38	34	45
2	17	38	24	49	31	60
3	14	45	21	53	27	68

⚠ WARNING Tool failure can cause serious injury. To prevent:

- When using holders without support bushing, use a short T-A Pro holder to establish an initial hole that is a minimum of 2 diameters deep.
- Do not rotate tool holders more than 50 RPM unless it is engaged with the workpiece or fixture.

Visit www.alliedmachine.com/DeepHoleGuidelines for the most up-to-date information and procedures.
 Factory technical assistance is available for your specific applications through our Application Engineering department. ext: 7611 | email: appeng@alliedmachine.com

IMPORTANT: The speeds and feeds listed above are a general starting point for all applications. Refer to the coolant recommendation chart for coolant requirements to run at the recommended speeds and feeds. Factory technical assistance is available through our Application Engineering department. For 7xD, 10xD, 12xD, and 15xD holder lengths, see adjustment example above.

A
DRILLING
B
BORING
C
REAMING
D
BURNISHING
E
THREADING
X
SPECIALS

Tap Drill Information and Formulas | Imperial (inch)

American - Unified Inch Screw Thread

Tap Size	Tap Drill Size	Decimal Equivalent	* Theo % Thread	Probable Mean Oversize	Probable Hole Size	** Probable % Thread
1/2 - 20	29/64	0.4531	72%	0.003	0.4561	68%
9/16 - 12	12.0 mm	0.4724	72%	0.003	0.4754	69%
	31/64	0.4844	83%	0.003	0.4874	80%
9/16 - 18	1/2	0.5000	87%	0.003	0.5030	82%
	13.0 mm	0.5118	70%	0.003	0.5148	66%
	31/64	0.5156	65%	0.003	0.5186	61%
5/8 - 11	17/32	0.5313	79%	0.003	0.5343	77%
5/8 - 12	35/64	0.5469	72%	0.003	0.5499	69%
5/8 - 18	9/16	0.5625	87%	0.003	0.5655	82%
	14.5 mm	0.5709	75%	0.003	0.5739	71%
	37/64	0.5781	65%	0.003	0.5811	61%
11/16 - 12	39/64	0.6094	72%	0.003	0.6124	69%
3/4 - 10	41/64	0.6406	84%	0.003	0.6436	82%
	16.5 mm	0.6496	77%	0.003	0.6526	75%
	21/32	0.6563	72%	0.003	0.6593	70%
3/4 - 12	43/64	0.6719	72%	0.003	0.6749	69%
3/4 - 16	11/16	0.6875	77%	0.003	0.6905	73%
	17.5 mm	0.6890	75%	0.003	0.6920	71%
7/8 - 9	49/64	0.7656	76%	0.003	0.7686	74%
	25/32	0.7813	65%	0.003	0.7843	63%
7/8 - 14	51/64	0.7969	84%	0.003	0.7999	81%
	13/16	0.8125	67%	0.003	0.8155	64%
15/16 - 12	55/64	0.8594	72%	0.003	0.8624	69%
15/16 - 20	57/64	0.8906	72%	0.003	0.8936	68%
1 - 8	22.0 mm	0.8661	82%	0.003	0.8691	81%
	7/8	0.8750	77%	0.003	0.8780	75%
	57/64	0.8906	67%	0.003	0.8936	65%
1 - 12	29/32	0.9063	87%	0.003	0.9093	84%
	59/64	0.9219	72%	0.003	0.9249	69%
1 - 14	15/16	0.9375	67%	0.003	0.9405	64%
1-1/8 - 12	1-1/32	1.0313	87%	0.003	1.0343	84%
	1-3/64	1.0469	72%	0.003	1.0499	69%
1-1/4 - 7	1-7/64	1.1094	76%	0.003	1.1124	74%

Taper Pipe Thread (NPT)

Tap Size	Tap Drill Size	Decimal Equivalent	* Theo % Thread	Probable Mean Oversize	Probable Hole Size	** Probable % Thread
1/4 - 18	7/16	0.4375	-	0.003	0.4405	-
3/8 - 18	9/16	0.5625	-	0.003	0.5655	-
1/2 - 14	45/64	0.7031	-	0.003	0.7061	-
3/4 - 14	29/32	0.9063	-	0.003	0.9093	-

* Based on nominal tap drill diameter

** Based on 0.003" probable mean oversize

To calculate the percent of full thread for a given hole diameter:

$$\% \text{ Thread} = \# \text{ of threads per inch} \cdot \frac{(\text{Basic major diameter of thread} - \text{Drill hole size})}{.0130}$$

Notes

- The above tap drill information represents probable thread percentages for the standard tap drills stocked at Allied Machine. Special insert diameters may be required in order to meet a user specific percentage of thread requirement.
- The 0.003" probable mean oversize hole condition is based on optimum cutting conditions. Probable percent of full thread may vary based on less ideal cutting conditions.
- The table and equations on this page are found in the *Machinery's Handbook*. Permission to simplify and print the equations is granted by the editor of the *Machinery's Handbook*.

Formulas

1.	RPM	= (3.82 • SFM) / DIA
	where:	
	RPM	= revolutions per minute (rev/min)
	SFM	= speed (ft/min)
	DIA	= diameter of drill (inch)
2.	IPM	= RPM • IPR
	where:	
	IPM	= inches per minute (in/min)
	RPM	= revolutions per minute (rev/min)
	IPR	= feed rate (in/rev)
3.	SFM	= RPM • 0.262 • DIA
	where:	
	SFM	= speed (ft/min)
	RPM	= revolutions per minute (rev/min)
	DIA	= diameter of drill (inch)
4.	Thrust	= 153,700 • IPR • DIA • K _m
	where:	
	Thrust	= axial thrust (lbs)
	IPR	= feed rate (in/rev)
	DIA	= diameter of drill (inch)
	K _m	= specific cutting energy (lbs/in ²)
5.	Tool Power	= .6991 • IPR • RPM • K _m • DIA ²
	where:	
	Tool Power	= tool power (HP)
	IPR	= feed rate (in/rev)
	RPM	= revolutions per minute (rev/min)
	K _m	= specific cutting energy (lbs/in ²)
	DIA	= diameter of drill (inch)

Material Constants

Type of Material	Hardness	K _m (lbs/in ²)
Plain Carbon and Alloy Steel	85 - 200 BHN	0.79
	200 - 275 BHN	0.94
	275 - 375 BHN	1.00
High-Temperature Alloys	-	1.44
Titanium Alloy	-	0.72
Stainless Steels	135 - 275 BHN	0.94
	30 - 45 RC	1.08
Cast Iron	100 - 200 BHN	0.50
	200 - 300 BHN	1.08
Copper Alloy	20 - 80 RB	0.43
	80 - 100 RB	0.72
Aluminum Alloy	-	0.22
Magnesium Alloy	-	0.16

Tap Drill Information and Formulas | Metric (mm)

Tap Size	Tap Drill Size	Decimal Equivalent (inch)	* Theo % Thread	Probable Mean Oversize	Probable Hole Size	** Probable % Thread
12 X 1.25	27/64	0.4219	79%	0.075 mm	10.79 mm	74%
	10.8 mm	0.4252	74%	0.075 mm	10.88 mm	69%
14 X 2.0	15/32	0.4688	81%	0.075 mm	11.98 mm	78%
	12.0 mm	0.4724	77%	0.075 mm	12.08 mm	74%
14 X 1.5	12.5 mm	0.4921	77%	0.075 mm	12.58 mm	73%
16 X 2.0	14.0 mm	0.5512	77%	0.075 mm	14.08 mm	74%
16 X 1.5	14.5 mm	0.5709	77%	0.075 mm	14.58 mm	73%
	37/64	0.5781	68%	0.075 mm	14.76 mm	64%
18 X 2.5	15.5 mm	0.6102	77%	0.075 mm	15.58 mm	75%
18 X 1.5	16.5 mm	0.6496	77%	0.075 mm	16.58 mm	73%
	21/32	0.6563	68%	0.075 mm	16.75 mm	64%
20 X 2.5	11/16	0.6875	78%	0.075 mm	17.54 mm	76%
	17.5 mm	0.6890	77%	0.075 mm	17.58 mm	74%
20 X 1.5	18.5 mm	0.7283	77%	0.075 mm	18.58 mm	73%
	47/64	0.7344	69%	0.075 mm	18.66 mm	65%
22 X 2.5	49/64	0.7656	79%	0.075 mm	19.52 mm	76%
	19.5 mm	0.7677	77%	0.075 mm	19.58 mm	75%
22 X 1.5	20.5 mm	0.8071	77%	0.075 mm	20.58 mm	73%
	13/16	0.8125	70%	0.075 mm	20.71 mm	66%
24 X 3	13/16	0.8125	86%	0.075 mm	20.71 mm	84%
	21.0 mm	0.8268	76%	0.075 mm	21.08 mm	75%
24 X 2	22.0 mm	0.8661	77%	0.075 mm	22.08 mm	74%
	7/8	0.8750	68%	0.075 mm	22.30 mm	65%
27 X 3	24.0 mm	0.9449	77%	0.075 mm	24.08 mm	75%

Formulas

1.	RPM = $(318.47 \cdot M/min) / DIA$ where: RPM = revolutions per minute (rev/min) M/min = speed (M/min) DIA = diameter of drill (mm)
2.	mm/min = $RPM \cdot mm/rev$ where: mm/min = mm per minute (mm/min) RPM = revolutions per minute (rev/min) mm/rev = feed rate (mm/rev)
3.	M/min = $RPM \cdot 0.003 \cdot DIA$ where: M/min = speed (M/min) RPM = revolutions per minute (rev/min) DIA = diameter of drill (mm)
4.	Thrust = $154 \cdot (mm/rev) \cdot DIA \cdot K_m$ where: Thrust = axial thrust (N) mm/rev = feed rate (mm/rev) DIA = diameter of drill (mm) K_m = specific cutting energy (kPa)
5.	Tool Power = $((mm/rev) \cdot RPM \cdot K_m \cdot DIA^2) / 218604.8$ where: Tool Power = tool power (HP) mm/rev = feed rate (mm/rev) RPM = revolutions per minute (rev/min) K_m = specific cutting energy (kPa) DIA = diameter of drill (mm)

BSP and ISO 7-1

Tap Size	Tap Drill Size	Decimal Equivalent	* Theo % Thread	Probable Mean Oversize	Probable Hole Size	** Probable % Thread
1/4-19	7/16	0.4375	-	0.075mm	11.19 mm	-
3/8-19	37/64	0.5781	-	0.075mm	14.76 mm	-
1/2-14	23/32	0.7188	-	0.075mm	18.33 mm	-
3/4-14	15/16	0.9375	-	0.075mm	23.89 mm	-

* Based on nominal tap drill diameter

** Based on 0.075mm probable mean oversize

To calculate the percent of full thread for a given hole diameter:

$$\% \text{ Thread} = \frac{76.93}{\text{Pitch (mm)}} \cdot (\text{Basic major diameter} - \text{Drill hole size})$$

Notes





- The above tap drill information represents probable thread percentages for the standard tap drills stocked at Allied Machine. Special insert diameters may be required in order to meet a user specific percentage of thread requirement.
- The 0.075mm probable mean oversize hole condition is based on optimum cutting conditions. Probable percent of full thread may vary based on less ideal cutting conditions.
- The table and equations on this page are found in the *Machinery's Handbook*. Permission to simplify and print the equations is granted by the editor of the *Machinery's Handbook*.

Material Constants

Type of Material	Hardness	K_m (kPa)
Plain Carbon and Alloy Steel	85 - 200 BHN	5.45
	200 - 275 BHN	6.48
	275 - 375 BHN	6.89
High-Temperature Alloys	375 - 425 BHN	7.93
	-	9.93
Titanium Alloy	-	4.96
Stainless Steels	135 - 275 BHN	6.48
	30 - 45 RC	7.45
Cast Iron	100 - 200 BHN	3.45
	200 - 300 BHN	7.45
Copper Alloy	20 - 80 RB	2.96
	80 - 100 RB	4.96
Aluminum Alloy	-	1.52
Magnesium Alloy	-	1.10

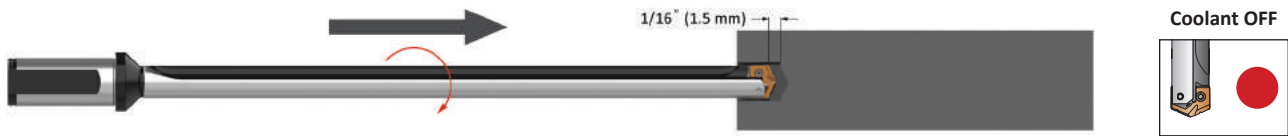
Deep Hole Drilling Guidelines

T-A Pro | 10xD, 12xD, and 15xD Holders

A DRILLING	<p>1. Pilot Hole 100 % RPM 100% IPR (mm/rev)</p>	<p>Establish the pilot hole using the same diameter short drill to a depth of 2xD minimum. Utilize a pilot drill with the same or larger included point angle.</p>	
B BORING	<p>2. Feed-in 50 RPM max 12 IPM (300 mm/min)</p>	<p>Feed the longer drill within 1/16" (1.5 mm) short of the established pilot hole bottom at a maximum of 50 RPM and 12 IPM (300 mm/min) feed rate.</p>	
C REAMING	<p>3. Deep Hole Transition Drilling 50 % RPM 75% IPR (mm/rev)</p>	<p>Drill additional 1xD past the bottom of the pilot hole at 50% reduction of recommended speed and 25% reduction of recommended feed. Minimum of one second dwell is required to meet full speed before feeding.</p>	
D BURNISHING	<p>4. Deep Hole Drilling - Blind 100% RPM 100% IPR (mm/rev)</p>	<p>Drill to full depth at recommended speed and feed for longer drill according to Allied speed and feed charts. No peck cycle recommended.</p>	
E THREADING	<p>5. Deep Hole Drilling - at Breakout 50% RPM 75% IPR (mm/rev)</p>	<p>For through holes only: Reduce speed by 50% and feed by 25% prior to breakout. Do not break out more than 1/8" (3 mm) past the full diameter of the drill.</p>	
X SPECIALS	<p>6. Drill Retract 50 RPM max</p>	<p>Reduce speed to a maximum of 50 RPM before retracting from the hole.</p>	

1. WARNING Tool failure can cause serious injury. To prevent:

- When using holders without support bushing, use a short T-A Pro holder to establish an initial hole that is a minimum of 2 diameters deep.
- Do not rotate tool holders more than 50 RPM unless it is engaged with the workpiece or fixture.

Visit www.alliedmachine.com/DeepHoleGuidelines for the most up-to-date information and procedures.

Factory technical assistance is available for your specific applications through our Application Engineering department. ext: 7611 | email: appeng@alliedmachine.com

Troubleshooting Guide

	Potential Problem																			
	Accelerated corner wear	Barber pole	Bell-mouth hole	Insert chipping	Blue chips	Built-Up Edge (BUE)	Chatter	Chip packing	Chipping of point	Damaged or broken tools	Excessive margin wear	High flank wear	Hole lead off	Hole out of position	Hole out of round	Over-size hole	Poor hole finish	Poor tool life	Power spikes - Load meter	
Setup Condition	1	2	3	4	5	6	7	8	9	10	11	12	13	14	15	16	17	18	19	Possible Solutions
Worn or misaligned spindle (lathe, screw machine, chucker)	1	2	3				7		9	10	11		13			16	17			<ul style="list-style-type: none"> Align spindle and turret or tailstock. Repair spindle.
Use of low rigidity machine tools		2	3	4			7		9	10			13	14						<ul style="list-style-type: none"> Reduce penetration rate to fall within the physical limits of the machine or setup (NOTICE: Do not reduce feed below threshold of good chip formation).
Poor work piece support		2		4			7			10	11				15		17			<ul style="list-style-type: none"> Provide additional support for the work piece. Reduce penetration rate to fall within the physical limits of the machine or setup (NOTICE: Do not reduce feed below threshold of good chip formation).
Flood coolant, low coolant pressure, or low coolant volume	1				5	6		8		10		12				16	17	18	19	<ul style="list-style-type: none"> Run coolant through tool holder when drilling greater than 1xD. Increase coolant pressure and volume through the tool holder. Reduce penetration rate to fall within the coolant limitations (NOTICE: Do not reduce feed below threshold of good chip formation). Add a peck cycle to help clear chips.
Interrupted cuts. Entry or exit surfaces that are not perpendicular to the spindle (draft angles, parting lines, curved or stepped surfaces, cross holes, and cast or forged surfaces)				4			7		9	10	11		13	14	15	16	17	18		<ul style="list-style-type: none"> Pre-mill (spot face) entry or exit surface to remove interruption. Decrease feed as much as 50% through entry or exit interruption. Use short holders in low impact entry cuts.
Material harder than expected or running tools beyond recommended speed	1				5	6				10		12						18		<ul style="list-style-type: none"> Reduce speed. Increase coolant pressure and volume. Improve coolant condition by use of quality products and regular maintenance.
Poor material micro-structure or foreign particles (forgings and castings that have not been normalized or annealed, poorly prepared steel, flame cut parts, and sand casting)				4		6				10		12	13					18		<ul style="list-style-type: none"> Compare performance of other tools for similar wear problems, which may indicate poor micro-structure. Anneal or normalize parts to improve micro-structure for machining. Reduce feeds (NOTICE: Do not reduce feed below threshold of good chip formation).
Poor chip control								8		10	11		13			16	17	18	19	<ul style="list-style-type: none"> Increase feed to recommended levels. Contact Allied's Application Engineering group for technical recommendations. Increase coolant pressure and volume. Improve coolant condition by use of quality products and regular maintenance.
Spot drilled holes with included angle less than that matching T-A Pro or cored holes	1			4			7						13					18		<ul style="list-style-type: none"> Spot hole with short tool of same or greater included angle as T-A Pro drill insert. Reduce feed (NOTICE: Do not reduce feed below threshold of good chip formation). If possible, drill from solid.

A

DRILLING

B

BORING

C

REAMING

D

BURNISHING

E

THREADING

X

SPECIALS

Guaranteed Test / Demo Application Form

Distributor PO #	
------------------	--

The following must be filled out completely before your test will be considered

Distributor Information

Company Name: _____
 Contact: _____
 Account Number: _____
 Phone: _____
 Email: _____

End User Information

Company Name: _____
 Contact: _____
 Industry: _____
 Phone: _____
 Email: _____

Current Process

List all tooling, coatings, substrates, speeds and feeds, tool life, and any problems you are experiencing

Test Objective

List what would make this a successful test (i.e. penetration rate, finish, tool life, hole size, etc.)

Application Information

Hole Diameter: _____ in/mm	Tolerance: _____	Material: _____ (4150 / A36 / Cast Iron / etc.)
Preexisting Diameter: _____ in/mm	Depth of Cut: _____ in/mm	Hardness: _____ (BHN / Rc)
Required Finish: _____ RMS	State: _____	(Casting / Hot rolled / Forging)

Machine Information

Machine Type: _____ (Lathe / Screw machine / Machine center / etc.)	Builder: _____ (Haas, Mori Seiki, etc.)	Model #: _____
Shank Required: _____ (CAT50 / Morse taper, etc.)		Power: _____ HP/KW
Rigidity: _____	Orientation: _____	Tool Rotating: _____
<input type="checkbox"/> Excellent	<input type="checkbox"/> Vertical	<input type="checkbox"/> Yes
<input type="checkbox"/> Good	<input type="checkbox"/> Horizontal	<input type="checkbox"/> No
<input type="checkbox"/> Poor		Thrust: _____ lbs/N

Coolant Information

Coolant Delivery: _____ (Through tool / Flood)	Coolant Pressure: _____ PSI / bar
Coolant Type: _____ (Air mist, oil, synthetic, water soluble, etc.)	Coolant Volume: _____ GPM / LPM

Requested Tooling

QTY	Item Number	QTY	Item Number



**ALLIED MACHINE
& ENGINEERING**

Allied Machine & Engineering
 120 Deeds Drive
 Dover, OH 44622

Telephone: (330) 343-4283
 Toll Free USA & Canada: (800) 321-5537
 Fax: (330) 602-3400

Warranty Information



Allied Machine & Engineering ("Allied Machine") warrants to original equipment manufacturers, distributors, industrial and commercial users of its products for one year from the original date of sale that each new product manufactured or supplied by Allied Machine shall be free from defects in material and workmanship.

Allied Machine's sole and exclusive obligation under this warranty is limited to, at its option, without additional charge, replacing or repairing this product or issuing a credit. For this warranty to be applied, the product must be returned freight prepaid to the plant designated by an Allied Machine representative and which, upon inspection, is determined by Allied Machine to be defective in material and workmanship.

Complete information as to operating conditions, machine, setup, and the application of cutting fluid should accompany any product returned for inspection. This warranty shall not apply to any Allied Machine products which have been subjected to misuse, abuse, improper operating conditions, improper machine setup or improper application of cutting fluid or which have been repaired or altered if such repair or alteration, in the judgement of Allied Machine, would adversely affect the performance of the product.

THIS WARRANTY IS IN LIEU OF ALL OTHER WARRANTIES, EXPRESS OR IMPLIED, INCLUDING ANY IMPLIED WARRANTY OF MERCHANTABILITY OR FITNESS FOR A PARTICULAR PURPOSE. Allied Machine shall have no liability or responsibility for any claim, whether in contract, tort or otherwise, for any loss or damage arising out of, connected with, or resulting from the manufacture, sale, delivery or use of any product sold hereunder, in excess of the cost of replacement or repair as provided herein.

Allied Machine shall not be liable in contract or in tort (including, without limitation, negligence, strict liability or otherwise) for economic losses of any kind or for any special, incidental, indirect, consequential, punitive or exemplary damages arising in any way out of the performance of, or failure to perform this agreement.

ALL PRICES, DELIVERIES, DESIGNS, AND MATERIALS ARE SUBJECT TO CHANGE WITHOUT NOTICE.



Allied Machine & Engineering
is registered to
ISO 9001:2015 by DQS

United States

Allied Machine & Engineering
120 Deeds Drive
Dover OH 44622
United States

Phone:
+1.330.343.4283
Fax:
+1.330.602.3400

Toll Free USA and Canada:
800.321.5537
Toll Free USA and Canada:
800.223.5140

Allied Machine & Engineering
485 W Third Street
Dover OH 44622
United States

Phone:
+1.330.343.4283
Fax:
+1.330.364.7666
(Engineering Dept.)

Toll Free USA and Canada:
800.321.5537

Europe

Allied Machine & Engineering Co. (Europe) Ltd.
93 Vantage Point
Pensnett Estate
Kingswinford
West Midlands
DY6 7FR England

Phone:
+44 (0) 1384.400900

Wohlhaupter GmbH
Maybachstrasse 4
Postfach 1264
72636 Frickenhausen
Germany

Phone:
+49 (0) 7022.408.0
Fax:
+49 (0) 7022.408.212

Asia

Wohlhaupter India Pvt. Ltd.
B-23, 3rd Floor
B Block Community Centre
Janakpuri, New Delhi - 110058
India

Phone:
+91 (0) 11.41827044

Your local Allied Machine representative:

www.alliedmachine.com

Allied Machine & Engineering is registered to ISO 9001:2015 by DQS

